



**Alaska
Department of
Transportation
and
Public Facilities**

**Alaska
Test Methods
Manual**

May 15, 2023

Preface

This manual provides a compilation of approved Test Methods, Forms and Standard Practices to be used to test materials on Alaska Department of Transportation & Public Facilities (DOT&PF) projects.

Most of these testing procedures follow two nationally recognized standards; American Society for Testing and Materials (ASTM), and the American Association of State Highway and Transportation Officials (AASHTO). Modifications to these standards are in recognition of the necessity of adjusting test requirements to meet local demands and/or naturally occurring materials.

This manual also includes Field Operating Procedures (FOPs) for existing AASHTO test methods. These procedures are developed and maintained by the Western Alliance for Quality in Transportation Construction (WAQTC). The FOPs select options and provide concise directions in the use of the AASHTO methods.

In addition, this manual includes WAQTC test methods that are not covered by AASHTO or ASTM. These methods have been submitted to AASHTO for adoption. Other procedures were developed by the Alaska DOT&PF to address specific needs in the State of Alaska that are not adequately covered in AASHTO, ASTM or WAQTC.

The Appendix contains standardized practices to be used by all DOT&PF regional and/or field laboratories including consultant fixed and field laboratories.

The test methods (including referenced test methods) in this manual refer to the most recent issue in effect on the date of the test, including interim publications or errata; unless the test methods (including referenced test methods) are specified by year or date.

Submit suggested additions, deletions or revisions to these procedures to the Statewide Materials Engineer and the Statewide Construction Standards Engineer.

This page intentionally left blank.

Acknowledgement

Design and Engineering Services, Statewide Materials is indebted to the following organizations for use of, or reference to, portions of their publications.

The American Association of State Highway and Transportation Officials
The American Society for Testing and Materials
The Western Alliance for Quality Transportation Construction (WAQTC)

Appreciation is also extended to Laboratory and Construction personnel from each Region for their dedication and patience in seeing this task to completion.

Fourteenth Edition Printing, 2023

List of Revisions for this edition:

ATM 207- minor revisions
ATM 213 – “probe” renamed “source rod”
ATM 303 – updating of mechanical splitter procedure and diagrams
ATM 304 – additional notes. Guidance page direction for sieve overload determination added.
ATM 401 – sections reorganized
ATM 402 – Safety language added to Scope
ATM 406 – minor clarifications
ATM 407 – note 1 removed, notes renumbered
ATM 408 - Guidance page direction for sieve overload determination added.
ATM 409 –updated to 2020 AASHTO – added “Annex A – Standardization of Bowl and Pycnometer or Volumetric Flask”
ATM 410 – minor revision and clarification
ATM 411 - added WAQTC to name in TOC. “Probe” changed to “source rod.”
ATM 415 - name changed “Preparing and Determining the Density of Asphalt Mixture Specimens by Means of the Superpave Gyrotory Compactor FOP for AASHTO T 312” added step (8) and note 6 to “compaction Procedure”
ATM 420 - Section 5 Apparatus – Frequency for 1. Abrasion apparatus added
ATM 501 – Aparatus updated. Minor revisions.
ATM 504 – procedure modified
ATM 505 – substantial procedure modifications
ATM 601 – updated blank test form and example calculations

This page intentionally left blank.

Table of Contents

Section 200 Earthwork

ATM 201	Sticks and Roots Content of Aggregate and Soil.....	201
ATM 202	WAQTC FOP for AASHTO T 255/T 265 Moisture Content of Aggregate and Soils*	202
ATM 203	Organic Content of Soils.....	203
ATM 204	WAQTC FOP for AASHTO T 89 Determining the Liquid Limit of Soils	204
ATM 205	WAQTC FOP for AASHTO T 90 Determining the Plastic Limit and Plasticity Index of Soils	205
ATM 206	pH of Topsoil.....	206
ATM 207	WAQTC FOP for AASHTO T 99/ T 180 Moisture-Density Relations of Soils*	207
ATM 211	Density of Soil In-Place by the Sand-Cone Method.....	211
ATM 212	Determining the Standard Density of Coarse Granular Materials using the Vibratory Compactor.....	212
ATM 213	WAQTC FOP for AASHTO T 310 In-Place Density and Moisture Content of Soil and Soil-Aggregate by Nuclear Methods (Shallow Depth)*	213
ATM 215	WAQTC FOP for AASHTO T 272 One-Point Method for Determining Maximum Dry Density and Optimum Moisture.....	215
ATM 216	WAQTC FOP for AASHTO R 75 Developing a Family of Curves.....	216

Section 300 Bases and Aggregates

ATM 301	WAQTC FOP for AASHTO R 90 Sampling Aggregate Products*	301
ATM 303	WAQTC FOP for AASHTO R 76 Reducing Samples of Aggregates to Testing Size*	303
ATM 304	WAQTC FOP for AASHTO T 27/T 11 Sieve Analysis of Fine and Coarse Aggregates*	304
ATM 305	WAQTC FOP for AASHTO T 335 Determining the Percentage of Fracture in Coarse Aggregate*.....	305
ATM 306	Determining the Percentage of Flat and Elongated Particles in Coarse Aggregate (Alaska FOP for ASTM D 4791)	306
ATM 307	WAQTC FOP for AASHTO T 176 Plastic Fines in Graded Aggregates and Soils by Use of the Sand Equivalent Test*	307
ATM 308	WAQTC FOP for AASHTO T 85 Specific Gravity and Absorption of Coarse Aggregate*	308
ATM 309	Relative Standard Density of Soils by the Control Strip Method	309
ATM 312	Nordic Abrasion Value of Coarse Aggregate	312
ATM 313	Degradation Value of Aggregates.....	313
ATM 314	Expansive Breakdown of Stone on Soaking in Ethylene Glycol.....	314
ATM 315	Gradation Count of Riprap.....	315
ATM 316	Dustfall Column Test.....	316

**This Test Method has specific guidelines for the use of the noted test method by the State of Alaska DOT&PF.*

ATM 317	Resistance of Coarse Aggregate to Degradation by Abrasion in the Micro-Deval Apparatus.....	317
---------	--	-----

Section 400 Asphalt

ATM 401	WAQTC FOP for AASHTO R 66 Sampling Asphalt Materials*	401
ATM 402	WAQTC FOP for AASHTO R 97 Sampling of Asphalt Mixtures*.....	402
ATM 403	Sampling Asphalt Mixtures	403
ATM 404	WAQTC FOP for AASHTO R 47 Reducing Samples of Asphalt Mixtures to Testing Size*	404
ATM 405	Asphalt Binder Content of Asphalt Mixtures by the Nuclear Method (Alaska FOP for AASHTO T 287)	405
ATM 406	WAQTC FOP for AASHTO T 308 Determining Asphalt Binder Content of Asphalt Mixtures by Ignition Method*.....	406
ATM 407	WAQTC FOP for AASHTO T 329 Moisture Content of Asphalt Mixtures by Oven Method*.....	407
ATM 408	WAQTC FOP for AASHTO T 30 Mechanical Analysis of Extracted Aggregate*	408
ATM 409	WAQTC FOP for AASHTO T 209 Theoretical Maximum Specific Gravity and Density of Asphalt Mixtures*	409
ATM 410	WAQTC FOP for AASHTO T 166 Bulk Specific Gravity of Asphalt Mixtures Using Saturated Surface-Dry Specimens *	410
ATM 411	WAQTC FOP for AASHTO T 355 In-Place Density of Asphalt Mixtures By Nuclear Methods*.....	411
ATM 412	Relative Standard Density of Treated Asphalt Mixtures by the Control Strip Method	412
ATM 413	FOP for AASHTO R 67 Sampling Asphalt Mixtures after Compaction (Obtaining Cores)*.....	413
ATM 414	Anti-Strip Requirements of Asphalt Mixtures	414
ATM 415	WAQTC FOP for AASHTO T 312 Preparing and Determining the Density of Asphalt Mixture Specimens by means of the Superpave Gyrotory Compactor.....	415
ATM 416	WAQTC TM 13 Volumetric Properties of Asphalt Mixtures	416
ATM 417	Asphalt Mixture Design by the Marshall Method	417
ATM 419	Rutting Susceptibility using an Asphalt Pavement Analyzer	419
ATM 420	Abrasion of Asphalt Mixtures by the Prall Method.....	420
ATM 421	Sieve Analysis of Crushed Asphalt Base Course/Recycled Asphalt Material/Pavement	421
ATM 423	Verification of Uniformity and Application Rate, or Residual Application Rate, of Asphaltic Material Distributors	423
ATM 424	Spot Test for Estimating Application Rate and Residual Application Rate, of Asphaltic Material Distributors	424
ATM 425	Interlayer Bond Strength Between Pavement Layers.....	425

**This Test Method has specific guidelines for the use of the noted test method by the State of Alaska DOT&PF.*

Section 500 Concrete

ATM 501	FOP for WAQTC TM 2 Sampling Freshly Mixed Concrete *.....	501
ATM 502	WAQTC FOP for AASHTO T 309 Temperature of Freshly Mixed Portland Cement Concrete.....	502
ATM 503	WAQTC FOP for AASHTO T 119 Slump of Hydraulic-Cement Concrete.....	503
ATM 504	WAQTC FOP for AASHTO T 121 Density (Unit Weight), Yield & Air Content (Gravimetric) of Concrete*.....	504
ATM 505	WAQTC FOP for AASHTO T 152 Air Content of Freshly Mixed Concrete by the Pressure Method*.....	505
ATM 506	WAQTC FOP for AASHTO R 100 Method of Making and Curing Concrete Test Specimens in the Field*.....	506
ATM 507	FOP for AASHTO R 64 Field Sampling and Fabrication of 50–mm (2-in) Cube Specimens using Grout (Non-Shrink) and or Mortar *.....	507
ATM 508	Slump Flow of Self-Consolidating Concrete (FOP For ASTM C 1611).....	508
ATM 509	Fabricating Test Specimens with Self-Consolidating Concrete	509
ATM 520	Certified Precast Concrete Plant Program	520
ATM 530	Concrete Mix Designs by ACI & Packing Density Methods	530

Section 600 Metal

ATM 601	Welded Lock Seam Strength of Corrugated Metal Pipe.....	601
---------	---	-----

Appendix 1 Standard Practices

SP 1	Terminology.....	SP 1
SP 2	Calibration of Mechanical Compaction Hammer/ Rammer	SP 2
SP 3	Reserved for WAQTC Discipline Policy.....	SP 3
SP 4	Random Sampling.....	SP 4
SP 5	ACI 301 References.....	SP 5
SP 6	Rounding and Precision in Materials Test Reporting	SP 6
SP 7	Determination of Outlier Test Results	SP 7
SP 8	Standard Practice for Standardization of Pressure Type Air Meter.....	SP 8
SP 9	Reserved.....	SP 9
SP 10	Worksheets with Examples.....	SP 10
SP 11	Reserved.....	SP 11
SP 12	Materials Sample Identification System	SP 12

**This Test Method has specific guidelines for the use of the noted test method by the State of Alaska DOT&PF.*

This page intentionally left blank.

ATM 201 Sticks & Roots Content of Aggregate and Soil

1. Scope

This is the procedure for determining the percent of sticks & roots by wet mass of the total aggregate or soil sample.

2. Significance

Use this test to quantify the organic content of soils for particles that are too large to test in accordance with ATM 203, Organic Content of Soils by Ignition.

3. Apparatus

- Balance or scale: Capacity sufficient for the field sample mass, readable to 0.1 percent or 0.1 g and meeting the requirements of AASHTO M 231.
- 2.00 mm (No. 10) sieve conforming to AASHTO M 92 (ASTM E11).
- Miscellaneous equipment including pans, gloves, etc.

4. Sampling and Sample Preparation

Obtain the sample in accordance with WAQTC FOP for AASHTO T 2 (ASTM D75). Perform the test on the complete as-received sample before drying.

5. Procedure

1. Determine the mass of the as-received sample to 0.1 percent or 0.1 g. Record this as the Total Sample Mass.
2. Separate the sample on a 2.00 mm (No. 10) sieve to ease identification of sticks & roots.
3. Separate the sticks & roots from the plus 2.00 mm (No. 10) material and place in a separate pan.
4. Determine the mass of the sticks & roots to 0.1 percent or 0.1 g. Record this as the Sticks & Roots Mass.

6. Calculations

Calculate the percentage of sticks & roots by:

$$\text{Sticks \& Roots, percent} = \left(\frac{\text{Sticks \& Roots Wet Mass}}{\text{Total Wet Sample Mass}} \right) \times 100$$

7. Report

- Results on forms approved by the Department
- Stick and Root Content to nearest 1 percent

This page left intentionally blank.

ATM 202 Moisture Content of Aggregate and Soils

The following are guidelines for using WAQTC FOP for AASHTO T 255/T 265 by the State of Alaska DOT&PF.

1. Use controlled methods of drying for most samples. It is assumed that constant mass has been reached for soils and aggregates when dried overnight (8-16 hours is sufficient in most cases). Shorter drying times require reweighing of samples until constant mass is achieved.
2. Uncontrolled methods of drying may be used when time is of the essence. These methods require reweighing of samples until constant mass is achieved.

This page intentionally left blank.

TOTAL EVAPORABLE MOISTURE CONTENT OF AGGREGATE BY DRYING FOP FOR AASHTO T 255

LABORATORY DETERMINATION OF MOISTURE CONTENT OF SOILS FOP FOR AASHTO T 265

Scope

This procedure covers the determination of moisture content of aggregate and soil in accordance with AASHTO T 255-22 and AASHTO T 265-22. It may also be used for other construction materials.

Overview

Moisture content is determined by comparing the wet mass of a sample and the mass of the sample after drying to constant mass. The term constant mass is used to define when a sample is dry.

Constant mass – the state at which a mass does not change more than a given percent, after additional drying for a defined time interval, at a required temperature.

Apparatus

- Balance or scale: capacity sufficient for the principal sample mass, accurate to 0.1 percent of sample mass or readable to 0.1 g, and meeting the requirements of AASHTO M 231
- Containers, clean, dry, and capable of being sealed
- Suitable drying containers
- Microwave safe container with ventilated lid
- Heat source, thermostatically controlled, capable of maintaining $110 \pm 5^{\circ}\text{C}$ ($230 \pm 9^{\circ}\text{F}$).
 - Forced draft oven (preferred)
 - Ventilated oven
 - Convection oven
- Heat source, uncontrolled, for use when allowed by the agency, will not alter the material being dried, and close control of the temperature is not required:
 - Infrared heater/heat lamp, hot plate, fry pan, or any other device/method allowed by the agency .
 - Microwave oven (900 watts minimum)
- Utensils such as spoons
- Hot pads or gloves

Sample Preparation

Obtain a representative sample according to the FOP for AASHTO R 90 in its existing condition. If necessary, reduce the sample to moisture content sample size according to the FOP for AASHTO R 76.

For aggregate, the moisture content sample size is based on Table 1 or other information that may be specified by the agency.

TABLE 1
Sample Sizes for Moisture Content of Aggregate

Nominal Maximum Size* mm (in.)	Minimum Sample Mass g (lb)
150 (6)	50,000 (110)
100 (4)	25,000 (55)
90 (3 1/2)	16,000 (35)
75 (3)	13,000 (29)
63 (2 1/2)	10,000 (22)
50 (2)	8000 (18)
37.5 (1 1/2)	6000 (13)
25.0 (1)	4000 (9)
19.0 (3/4)	3000 (7)
12.5 (1/2)	2000 (4)
9.5 (3/8)	1500 (3.3)
4.75 (No. 4)	500 (1.1)

* One sieve larger than the first sieve to retain more than 10 percent of the material using an agency specified set of sieves based on cumulative percent retained. Where large gaps in specification sieves exist, intermediate sieve(s) may be inserted to determine nominal maximum.

For soils the moisture content sample size is based on Table 2 or other information that may be specified by the agency.

TABLE 2
Sample Sizes for Moisture Content of Soil

Maximum Particle Size mm (in.)	Minimum Sample Mass g
50 (2)	1000
25.0 (1)	500
12.5 (1/2)	300
4.75 (No. 4)	100
0.425 (No. 40)	10

Immediately seal or cover moisture content samples to prevent any change in moisture content or follow the steps in "Procedure."

Procedure

Determine and record the sample mass as follows:

- For aggregate, determine and record all masses to the nearest 0.1 percent of the sample mass or to the nearest 0.1 g.
- For soil, determine and record all masses to the nearest 0.1 g.

When determining the mass of hot samples or containers or both, place and tare a buffer between the sample container and the balance. This will eliminate damage to or interference with the operation of the balance or scale.

1. Determine and record the mass of the container (and lid for microwave drying).
 2. Place the wet sample in the container.
 3. Determine and record the total mass of the container and wet sample.
 - a. For oven(s), hot plates, infrared heaters, etc.: Spread the sample in the container.
 - b. For microwave oven: Heap sample in the container; cover with ventilated lid.
 4. Determine and record the wet mass of the sample (M_w) by subtracting the container mass determined in Step 1 from the mass of the container and sample determined in Step 3.
 5. Place the sample in one of the following drying apparatuses:
 - a. For aggregate –
 - i. Controlled heat source (oven): at $110 \pm 5^\circ\text{C}$ ($230 \pm 9^\circ\text{F}$).
 - ii. Uncontrolled heat source (Hot plate, infrared heater, or other heat source as allowed by the agency): Stir frequently to avoid localized overheating.
 - b. For soil – controlled heat source (oven): at $110 \pm 5^\circ\text{C}$ ($230 \pm 9^\circ\text{F}$).
- Note 1:** Soils containing gypsum or significant amounts of organic material require special drying. For reliable moisture contents dry these soils at 60°C (140°F). For more information see AASHTO T 265, Note 2.
6. Dry until sample appears moisture free.
 7. Determine mass of sample and container.
 8. Determine and record the mass of the sample by subtracting the container mass determined in Step 1 from the mass of the container and sample determined in Step 7.
 9. Return sample and container to the heat source for additional drying.
 - a. For aggregate –
 - i. Controlled heat source (oven): 30 minutes
 - ii. Uncontrolled heat source (Hot plate, infrared heater, or other heat source as allowed by the agency): 10 minutes
 - iii. Uncontrolled heat source (Microwave oven): 2 minutes
- Caution:** Some minerals in the sample may cause the aggregate to overheat, crack, and explode; altering the aggregate gradation.
- b. For soil – controlled heat source (oven): 1 hour
10. Determine mass of sample and container.

11. Determine and record the mass of the sample by subtracting the container mass determined in Step 1 from the mass of the container and sample determined in Step 10.
12. Determine percent change by subtracting the new mass determination (M_n) from the previous mass determination (M_p) divide by the previous mass determination (M_p) multiply by 100.
13. Continue drying, performing steps 9 through 12, until there is less than a 0.10 percent change after additional drying time.
14. Constant mass has been achieved; sample is defined as dry.
15. Allow the sample to cool. Immediately determine and record the total mass of the container and dry sample.
16. Determine and record the dry mass of the sample (M_D) by subtracting the mass of the container determined in Step 1 from the mass of the container and sample determined in Step 15.
17. Determine and record percent moisture (w) by subtracting the final dry mass determination (M_D) from the initial wet mass determination (M_w) divide by the final dry mass determination (M_D) multiply by 100.

**Table 3
Methods of Drying**

Aggregate		
Heat Source	Specific Instructions	Drying intervals to achieve constant mass (minutes)
Controlled:		
Forced draft (preferred), ventilated, or convection oven	$110 \pm 5^\circ\text{C}$ ($230 \pm 9^\circ\text{F}$)	30
Uncontrolled:		
Hot plate, infrared heater, or any other device/method allowed by the agency	Stir frequently	10
Microwave	Heap sample and cover with ventilated lid	2
Soil		
Heat Source	Specific Instructions	Drying increments (minutes)
Controlled:		
Forced draft (preferred), ventilated, or convection oven	$110 \pm 5^\circ\text{C}$ ($230 \pm 9^\circ\text{F}$)	1 hour

Calculation

Constant Mass

Calculate constant mass using the following formula:

$$\% \text{ Change} = \frac{M_p - M_n}{M_p} \times 100$$

Where:

M_p = previous mass measurement

M_n = new mass measurement

Example:

Mass of container:	1232.1 g
Mass of container and sample after first drying cycle:	2637.2 g
Mass, M_p , of possibly dry sample:	$2637.2 \text{ g} - 1232.1 \text{ g} = 1405.1 \text{ g}$
Mass of container and sample after second drying cycle:	2634.1 g
Mass, M_n , of sample:	$2634.1 \text{ g} - 1232.1 \text{ g} = 1402.0 \text{ g}$

$$\% \text{ Change} = \frac{1405.1 \text{ g} - 1402.0 \text{ g}}{1405.1 \text{ g}} \times 100 = 0.22\%$$

0.22 percent is not less than 0.10 percent, so continue drying.

Mass of container and sample after third drying cycle: 2633.0 g

Mass, M_n , of sample: $2633.0 \text{ g} - 1232.1 \text{ g} = 1400.9 \text{ g}$

$$\% \text{ Change} = \frac{1402.0 \text{ g} - 1400.9 \text{ g}}{1402.0 \text{ g}} \times 100 = 0.08\%$$

0.08 percent is less than 0.10 percent, so constant mass has been reached.

Moisture Content:

Calculate the moisture content, as a percent, using the following formula:

$$w = \frac{M_W - M_D}{M_D} \times 100$$

Where:

- w = moisture content, percent
- M_W = wet mass
- M_D = dry mass

Example:

Mass of container:	1232.1 g
Mass of container and wet sample:	2764.7 g
Mass, M _W , of wet sample:	2764.7 g - 1232.1 g = 1532.6 g
Mass of container and dry sample (COOLED):	2633.5 g
Mass, M _D , of dry sample:	2633.5 g - 1232.1 g = 1401.4 g

$$w = \frac{1532.6 \text{ g} - 1401.4 \text{ g}}{1401.4 \text{ g}} \times 100 = \frac{131.2 \text{ g}}{1401.4 \text{ g}} \times 100 = 9.36\% \text{ report } 9.4\%$$

Report

- On forms approved by the agency
- Sample ID
- M_W, wet mass
- M_D, dry mass
- w, moisture content to the nearest 0.1 percent

ATM 203 Organic Content of Soils

1. Scope

This method describes the procedure for determining organic content of soils by loss on ignition as adopted from ASTM D2974.

This standard involves hazardous materials, operations and equipment. This standard does not purport to address all of the safety problems associated with its use. It is the responsibility of the agency to establish appropriate safety and health practices and to train the user of this standard prior to use. It is the responsibility of the user to consult the appropriate agency authority for and to practice and maintain the appropriate safety and health practices.

2. Apparatus

- Sieves conforming to AASHTO M 92 (ASTM E11)
- Pulverizing apparatus suitable for breaking up aggregations of soil particles without reducing the size of individual grains
- Balance or scale: Class G1, sensitive to 0.01 g with a capacity sufficient for the principle sample mass, and meeting the requirements of AASHTO M 231
- For this test, this would require a scale with a capacity of at least 150 g and readable to 0.01 g
- Muffle Furnace, thermostatically controlled, capable of maintaining a temperature of $445 \pm 10^{\circ}\text{C}$ ($830 \pm 15^{\circ}\text{F}$). The combustion chamber will be capable of accommodating the designated container(s) and sample(s). The furnace shall be equipped with a pyrometer recorder that will indicate chamber temperature while in use.
- Crucible, with covers, having a minimum volume of 100 ml and capable of withstanding repeated exposure to temperatures of 500°C (950°F)
- Non-asbestos, heat-resistant, gauntlet-type gloves capable of withstanding temperatures of 500°C (950°F)
- Desiccator of sufficient size containing an effective desiccant
- Miscellaneous equipment including tongs, spatulas, wire brushes, etc.

3. Sampling and Sample Preparation

1. Obtain the sample in accordance with WAQTC FOP for AASHTO T 2 (ASTM D75).
2. Dry the sample to constant mass in accordance with the soil procedure of WAQTC FOP for AASHTO T 255/T 265.
3. If the material contains lumps of organics or aggregations of soil, they shall be broken up by such means that will not reduce the size of the aggregate particles. Sieve the dry sample through the 4.75 (No. 4) sieve.

Note 1: Sticks and roots shall not be broken up, but shall be removed by hand and reported as Sticks and Roots (see ATM 201).

4. Reduce the sample to a mass of approximately 50 g in accordance with WAQTC FOP for AASHTO T 248.

4. Procedure

1. Determine the mass of a crucible to the nearest 0.01 g and record as Tare.
2. Place the sample into the crucible, determine the mass to the nearest 0.01 g and record as Mass Before Ignition + Tare.

Note 2: Sample masses for lightweight materials such as peat may be less than 50 g but should be of sufficient amount to fill the crucible to at least 3/4 depth. A cover may initially be required over the crucible during the initial phase of ignition to decrease the possibility of the sample being "blown out" from container.

3. Place the crucible into a pre-heated muffle furnace at a temperature of 445°C (835°F) for a minimum of six hours until the sample is completely ashed (no change of mass occurs after at least 1 hr. of additional heating. If a cover has been used, it shall be removed after approximately 2 hours of combustion.
4. Remove the test sample from the muffle furnace and cool it to room temperature in a desiccator.
5. Determine the mass to the nearest 0.01 grams and record as Mass After Ignition + Tare.

5. Calculations

Calculate the percent organic content by the following formula:

$$\text{Organic Content} = \left(\frac{A - B}{A - C} \right) \times 100$$

Where:

A = Mass Before Ignition + Tare,
B = Mass After Ignition + Tare,
C = Tare.

6. Report

- Results on forms approved by the Department
- Organic Content to nearest 0.1 percent

ATM 204 Determining the Liquid Limit of Soils

Use WAQTC FOP Module T 89-1 for AASHTO T 89.

DETERMINING THE LIQUID LIMIT OF SOILS FOP FOR AASHTO T 89

Scope

This procedure covers the determination of the liquid limit of a soil in accordance with AASHTO T 89-13. It is used in conjunction with the FOP for AASHTO T 90, Determining the Plastic Limit and Plasticity Index of Soils. The three values are used for soil classification and other purposes.

Apparatus

- Dish: preferably unglazed porcelain or similar mixing dish, about 115 mm (4.5 in.) in diameter.
- Spatula: having a blade 75 to 100 mm (3 to 4 in.) long and about 20 mm (3/4 in.) wide.
- Liquid Limit Device: manually or mechanically operated, consisting of a brass cup, carriage, and base plate and conforming to the critical dimensions shown in AASHTO T 89 Figure 1.
- Grooving Tool: used to cut the soil in the liquid limit device cup and conforming to the critical dimensions shown in AASHTO T 89 Figure 1.
- Gauge: either part of the grooving tool or a separate metal bar, 10.0 ± 0.2 mm (0.394 ± 0.008 in.) thick and approximately 50 mm (2 in.) long.
- Containers: corrosion resistant, suitable for repeated heating and cooling, having close fitting lids to prevent the loss of moisture. One container is needed for each moisture content determination.
- Balance: conforming to AASHTO M 231, class G1, sensitive to 0.01 g with a minimum capacity of 100 g.
- Oven: thermostatically controlled, capable of maintaining temperatures of $110 \pm 5^\circ\text{C}$ ($230 \pm 9^\circ\text{F}$).
- Graduated cylinders for measuring distilled or demineralized water.

Adjustment of Liquid Limit Device

The liquid limit device shall be inspected to determine that the device is in good working order; that the pin connecting the cup is not worn to permit side play; that the screws connecting the cup to the hanger are tight; that the points of contact on the cup and base are not excessively worn; that the lip of the cup is not excessively worn; and that a groove has not been worn in the cup. The grooving tool shall be inspected to determine that the critical dimensions are correct.

Note 1: Wear is considered excessive when the point of contact on the cup or base exceeds approximately 13 mm (0.5 in.) in diameter, or when any point on the rim of the cup is worn to approximately 1/2 the original thickness. A slight groove in the center of the cup is not objectionable. If the groove becomes pronounced, the cup shall be replaced. A base that is excessively worn may be refinished as long as it is maintained within the tolerances specified.

Adjust the height of drop of the cup so that the point on the cup that comes in contact with the base rises to a height of 10.0 ± 0.2 mm (0.394 ± 0.008 in.).

Note 2: Check the height of the drop, before each new sample, by turning the crank at two revolutions per second while holding the gauge in position against the cup. If a ringing or clicking sound is heard without the cup rising from the gauge, the adjustment is correct. If no ringing is heard or if the cup rises from gauge, readjust the height of the drop. If the cup rocks on the gauge during this checking operation, the cam follower pivot is excessively worn and should be replaced.

Sample

Samples must be prepared per the FOP for AASHTO T 87 or T 146. Obtain a sample with a mass of about 100 g taken from the portion of the material passing the 0.425 mm (No. 40) sieve.

The mass required depends upon the method chosen. Method A (multi-point method) requires approximately 100 g. Method B (single point method) requires approximately 50 g.

Procedure – Method A (Multi-Point)

1. Place the sample in the dish and thoroughly mix with 15 to 20 mL of distilled or demineralized water by alternately and repeatedly stirring, kneading, and chopping with a spatula. Further additions of water shall be in increments of 1 to 3 mL. Each increment shall be thoroughly mixed with the soil before another increment is added. Once testing has begun, no additional dry soil should be added to the moistened soil. The cup of the Liquid Limit device shall not be used for mixing soil and water. If too much water is added, the sample shall either be discarded or mixed and kneaded until natural evaporation lowers the moisture content.

Note 3: Some soils are slow to absorb water. It is possible to add water so fast that a false LL value is obtained. This can be avoided by allowing more mixing and/or time. Also, tap water may be used for routine testing if comparative tests indicate no differences in results between using tap water and distilled or demineralized water.

2. Add sufficient water to form a uniform mass of a stiff consistency.
3. Place enough material in the cup so that, when squeezed and spread with the spatula, the soil will rest in the cup above the spot where the cup rests on the base and will be 10 mm thick at the point of maximum thickness. Use as few strokes of the spatula as possible, taking care to prevent the entrapment of air bubbles in the sample.
4. Divide the soil in the cup with a firm stroke of the grooving tool. Avoid tearing of the sides of the groove or slipping of the soil cake on the cup. Up to six strokes are permitted with a stroke from front to back or from back to front counting as 1 stroke. The depth of the groove should be increased with each stroke, and only the last stroke should scrape the bottom of the cup.
5. Lift and drop the cup by turning the crank at a rate of approximately two revolutions per second until the two halves of the soil pat come together along a distance of about 13 mm (0.5 in.). Do not hold the base while the crank is turned. Record the number of shocks required to close the groove this distance.

Note 4: Some soils tend to slide on the cup instead of flowing. If this occurs, water should be added, the sample remixed, and the procedure repeated. If the soil continues to slide on the cup, the test is not applicable and a note should be made that the liquid limit could not be determined.

6. Use the spatula to obtain a moisture content sample by slicing through the soil pat perpendicularly to the groove. Remove the sample extending edge to edge and including the portion of the groove that flowed together. Place it into a suitable container and cover for subsequent moisture determination.
7. Determine the moisture percentage of the moisture content sample in accordance with the FOP for AASHTO T 255/T 265 (Soil).
8. Place the soil remaining in the cup back in the mixing dish and add 1 to 3 mL of water, or use previously prepared portions to which sufficient water has been added to result in a more fluid condition.
9. Repeat Steps 3 through 8, a minimum of two times. The object is to have a determination in all three shock ranges 25-35, 20-30, and 15-25 and span a range of at least 10 shocks.

Flow Curve – Method A

Prepare a flow curve on a semi-logarithmic graph with moisture content on the arithmetic vertical axis and the number of shocks on the logarithmic horizontal axis. The flow curve is a straight line drawn as closely as possible through three or more plotted points.

Liquid Limit – Method A

Determine the liquid limit. The moisture content at the intersection of the flow curve and the 25 shock line is the liquid limit.

Procedure – Method B (Single-Point)

1. Place the sample in the dish and thoroughly mix with 8 to 10 mL of distilled or demineralized water, and following the mixing procedure in Method A, Step 1.
2. Follow the procedure in Method A except that the soil pat should be prepared with water to produce a consistency that will close the two halves of the soil pat at least 13 mm (0.5 in.) within 22 to 28 shocks of the cup.

Note 5: Groove closures occurring between 15 and 40 blows may be accepted if variations of ± 5 percent of the true liquid limit are tolerable.

3. Return the soil remaining in the cup to the mixing dish and, without adding any additional water, repeat Step 2. If the closure again occurs within the acceptable range and is within 2 shocks of the first, obtain a moisture content specimen as described in Method A.
4. Determine the moisture content of the moisture content sample in accordance with the FOP for AASHTO T 255/T 265 (Soil).

Liquid Limit – Method B

Calculate the liquid limit as follows:

$$LL = (w_N)(N/25)^{0.121}$$

Table 1

<u>N</u>	<u>$(N/25)^{0.121}$</u>
22	0.985
23	0.990
24	0.995
25	1.000
26	1.005
27	1.009

Where:

- LL = liquid limit
- w_N = moisture content of sample at N blows
- N = number of blows

Example:

$$w_N = 16.0 \% \quad \text{and} \quad N = 23$$

$$LL = 16.0 \times \left(\frac{23}{25}\right)^{0.121} = 15.8\%, \text{ report } 16\%$$

Or using Table 1 (when number of shocks to closure of gap is 22-28):

$$LL = 16.0 \times 0.990 = 15.8\%, \text{ report } 16\%$$

Report

- Results on forms approved by the agency
- LL rounded to the nearest 1 percent.

This page intentionally left blank.

ATM 205 Determining the Plastic Limit and Plasticity Index of Soils

Use WAQTC FOP Module T 90 for AASHTO T 90.

This page intentionally left blank.

DETERMINING THE PLASTIC LIMIT AND PLASTICITY INDEX OF SOILS FOP FOR AASHTO T 90

Scope

This procedure covers the determination of the plastic limit and plasticity index of soil in accordance with AASHTO T 90-16. It is used in conjunction with the FOP for AASHTO T 89, Determining the Liquid Limit of Soils. The three values are used for soil classification and other purposes. Two procedures, hand rolling and an alternate rolling method, are covered. The hand rolling method is to be used as the referee method.

Apparatus

- Dish: preferably unglazed porcelain or similar mixing dish, about 115 mm (4.5 in.) in diameter.
- Spatula: having a blade 75 to 100 mm (3 to 4 in.) long and about 20 mm (3/4 in.) wide.
- Rolling Surface:
 - A ground glass plate or piece of smooth, unglazed paper.
 - Plastic Limit Rolling Device: (Optional) A device made of acrylic conforming to the dimensions shown in AASHTO T 90 Figure 1.
 - Paper for Rolling Device: Unglazed paper that does not add foreign matter to the soil during the rolling process. Paper is attached to both the top and bottom plates of the rolling device by either spray-on adhesive or self-adhesive backing. Remove all adhesive from the rolling device after each test to prevent buildup.
- Containers: corrosion resistant, suitable for repeated heating and cooling, having close fitting lids to prevent the loss of moisture before initial mass determination and while sample is cooling before final mass determination. One container is needed for each moisture content determination.
- Balance: conforming to AASHTO M 231, class G1, sensitive to 0.01 g with a minimum capacity of 100 g.
- Oven: thermostatically controlled, capable of maintaining temperatures of $110 \pm 5^{\circ}\text{C}$ ($230 \pm 9^{\circ}\text{F}$).

Sample

The plastic limit procedure is often run in conjunction with the liquid limit procedure. If this is the case, the plastic limit sample should be obtained from the soil prepared for the liquid limit test, FOP for AASHTO T 89, at any point in the process at which the soil is plastic enough to be easily shaped into a ball without sticking to the fingers excessively when squeezed. Obtain approximately 10 g of soil to run the plastic limit test.

If the plastic limit only is to be determined, the sample must be prepared according to AASHTO R 58; Dry Preparation of Disturbed Soil and Soil-Aggregate Samples for Test or R 74; Wet Preparation of Disturbed Soil Samples for Test. Obtain about 20 g of material passing the 0.425 mm (No. 40) sieve. Mix the soil with distilled or demineralized water until the mass becomes plastic enough to be easily shaped into a ball. Use approximately 10 g of the soil ball to run the plastic limit test.

Note 1: Tap water may be used for routine testing if comparative tests indicate no differences in results between using tap water and distilled or demineralized water.

Procedure

1. Determine and record the mass of the container and lid
2. Pull a 1.5 to 2 g mass test sample from the initial 10 g.
3. Squeeze and form the test sample into an ellipsoidal-shape mass.
4. Use one of the following methods to roll the mass.
 - Hand Rolling Method—Roll the mass between the fingers or palm and the rolling surface with just sufficient pressure to roll the mass into a thread of uniform diameter along its length. The sample must be rolled into the 3 mm (1/8 in.) thread in no longer than 2 minutes.
 - Alternate Rolling Method, Plastic Limit Device Method—Place the soil mass on the bottom plate. Place the top plate in contact with the soil mass. Roll the mass between the plates with sufficient pressure to form the mass into a thread of uniform diameter along its length so that top plate contacts the side rails within 2 minutes. During this rolling process, do not allow the soil thread to contact the side rails. Rolling multiple threads at once is allowed.
5. Break the thread into six or eight pieces when the diameter of the thread reaches 3 mm (1/8 in.).
6. Squeeze the pieces together between the thumbs and fingers of both hands into an ellipsoidal-shape mass and reroll.

Continue this process of alternately rolling to a thread 3 mm (1/8 in.) in diameter, cutting into pieces, gathering together, kneading and rerolling until the thread crumbles under the pressure required for rolling and the soil can no longer be rolled into a thread 3 mm in diameter.

Crumbling may occur when the thread has a diameter greater than 3 mm (1/8 in.). This shall be considered a satisfactory end point, provided the soil has been previously rolled into a thread 3 mm (1/8 in.) in diameter. At no time, shall the tester attempt to produce failure at exactly 3 mm (1/8 in.) diameter. It is permissible, however, to reduce the total amount of deformation for feebly plastic soils by making the initial diameter of the ellipsoidal-shaped mass nearer to the required 3 mm (1/8 in.) final diameter.

Note 2: The crumbling will manifest itself differently with various types of soil. Some soils fall apart in many pieces; others form an outside tubular layer that splits at both ends; splitting progresses toward the middle, and the thread falls apart in small platy particles. Heavy clay requires much pressure to deform the thread, particularly as it approaches the plastic limit, and the thread breaks into a series of barrel-shaped segments each 6 to 9 mm (1/4 to 3/8 in.) long.

7. Gather the portions of the crumbled soil together, place in the moisture content container and cover.
8. Repeat steps one through seven until 10 g of sample have been tested and placed in the covered container.

- Determine the moisture content of the sample in accordance with the FOP for AASHTO T 255/T 265 (Soil) and record the results.

Plastic Limit

The moisture content, as determined in Step 9 above, is the Plastic Limit.

Note 3: It is advisable to run several trials on the same material to ensure a proper determination of the Plastic Limit of the soil.

Plasticity Index

The Plasticity Index (PI) of the soil is equal to the difference between the Liquid Limit (LL) and the Plastic Limit (PL). If either the liquid limit or plastic limit cannot be determined, report the plasticity index as NP (non-plastic). If the plastic limit is equal to, or greater than the liquid limit, report the plasticity index as NP.

$$PI = LL - PL$$

Examples:

#1

$$LL = 34 \text{ and } PL = 17$$

$$PI = 34 - 17 = 17$$

#2

$$LL = 16 \text{ and } PL = 10$$

$$PI = 16 - 10 = 6$$

Example Calculation

Container	Container Mass, g	Container and Wet Soil Mass, g	Wet Soil Mass, g	Container and Dry Soil Mass, g	Dry Soil Mass, g
1	14.44	25.21	10.77	23.62	9.18
2	14.18	24.84	10.66	23.90	9.72

Water Mass, g	Moisture Content	Plastic Limit
1.59	17.3%	17
0.94	9.7%	10

Report

- Results on forms approved by the agency
- PL and PI rounded to the nearest 1 percent and reported as a whole number.

This page intentionally left blank.

ATM 206 pH of Topsoil

1. Scope

This method describes the procedure for determining the pH of topsoil.

2. Apparatus

- A soil test kit capable of determining the pH of soils. These are available from commercial greenhouses. Verify reagent expiration dates and replace as needed.
- pH Meter—Calibrate according to manufacturer's recommendations.
- 2.00 mm (No. 10) sieve conforming to ASTM E11.

3. Sampling and Sample Preparation

1. Obtain the sample in accordance with WAQTC FOP for AASHTO T 2 (ASTM D75).
2. Prepare the soil sample in accordance with AASHTO R 58 and the manufacturer's instructions for the soils kit.

4. Procedure

1. Separate sample on a 2.00 mm (No. 10) sieve. Discard the plus 2.00 mm (No. 10) material unless required for other testing.
2. Determine the pH of the minus 2.00 mm (No. 10) material in accordance with the manufacturer's instructions.

5. Report

- PH value to the nearest 0.5.

This page intentionally left blank

ATM 207 Moisture Density Relations of Soil

The following are DOT&PF guidelines for using WAQTC FOP for AASHTO T 99/T 180.

1. ASTM D4253 or ATM 212 are more appropriate to determine standard density values for compaction control of non-plastic or manufactured aggregate materials.
2. Moisture content shall be determined using the mass requirements listed in table 2 of WAQTC FOP for AASHTO T 255/T 265.
3. Under Table 1 and 2 insert:

Molds Out of Tolerance Due to Use — A mold that fails to meet manufacturing tolerances after continued service may remain in use provided those tolerances are not exceeded by more than 50 percent; and the volume of the mold, calibrated in accordance with Annex B of this method, is used in the calculations.

4. For Procedure step #5, to attain a true representation based on the volume of the mold, use a No. 4, No. 8, or No. 10 sieve to generate fine material suitable for filling any voids remaining after trimming.
5. In order to properly draw the moisture-density curve, it may be helpful to plot a Zero Air Voids (ZAV) curve. The ZAV curve must be to the right of the wet side of the curve. To plot the curve, you will need to establish the specific gravity of the soil. Specific gravity of the soil can be estimated, assumed to be 2.700, or it can be determined in accordance with AASHTO T 100.
6. The points for plotting the ZAV shall be calculated by selecting dry unit masses and calculating a corresponding moisture content value as follows:

$$W_s = \frac{(\gamma_w)G_s - \gamma_d}{(\gamma_d)(G_s)} \times 100$$

Where:

- W_s = Water content for complete saturation, %
- γ_w = Unit Mass of water 9.789 kN/m³ (62.4 lbf/ft³)
- γ_d = Dry unit mass of soil, kN/m³ (lbf/ft³)
- G_s = Specific Gravity of soil or G_{avg} as described below

7. When the material includes plus 4.75 mm (No. 4) materials, the plus 4.75 mm (No. 4) specific gravity may be estimated, assumed to be 2.700 or it can be tested in accordance with WAQTC FOP for AASHTO T 85. If a weighted average is used, it shall be calculated as follows:

$$G_{avg} = \frac{1}{\frac{R_1}{100G_1} + \frac{P_1}{100G_2}}$$

Where:

- G_{avg} = Weighted average specific gravity of soils
- R_1 = Percent of soil particles retained on the 4.75 mm (No. 4) sieve
- P_1 = Percent of soil particles passing the 4.75 mm (No. 4) sieve
- G_1 = Apparent specific gravity of soil particles retained on the 4.75 mm (No. 4) sieve
- G_2 = Specific gravity of soil particles passing the 4.75 mm (No. 4) sieve

8. The use of an extruder is optional when the sample being tested is granular.
9. Calculate wet density by Measured Volume as shown in Calculations 1.

Annex A

1. The maximum allowable oversized (+19 mm [3/4 in]) material is 40 percent. The maximum dry density to be used with material containing 30 to 40 percent oversized is the oversized correction calculated at 30 percent.
2. Along with density, the moisture content can be corrected. The moisture content can be determined by the FOP for AASHTO T 255 / T 265, other agency approved methods, or the nuclear density gauge moisture content reading from the FOP for AASHTO T 310. If the nuclear gauge moisture reading is used, or when the moisture content is determined on the entire sample (both fine and oversized particles), the use of the “Optimum Moisture Correction Equation” is not needed. Combined moisture contents with material having an appreciable amount of silt or clay should be performed using FOP for AASHTO T 255 / T 265 (Soil). Moisture contents used from FOP for AASHTO T 310 must meet the criteria for that method.

MOISTURE-DENSITY RELATIONS OF SOILS: USING A 2.5 KG (5.5 LB) RAMMER AND A 305 MM (12 IN.) DROP FOP FOR AASHTO T 99

USING A 4.54 KG (10 LB) RAMMER AND A 457 MM (18 IN.) DROP FOP FOR AASHTO T 180

Scope

This procedure covers the determination of the moisture-density relations of soils and soil-aggregate mixtures in accordance with two similar test methods:

- AASHTO T 99-22: Methods A, B, C, and D
- AASHTO T 180-22: Methods A, B, C, and D

This test method applies to soil mixtures having 40 percent or less retained on the 4.75 mm (No. 4) sieve for methods A or B, or 30 percent or less retained on the 19 mm (¾ in.) sieve with methods C or D. The retained material is defined as oversize (coarse) material. If no minimum percentage is specified, 5 percent will be used. Samples that contain oversize (coarse) material that meet percent retained criteria should be corrected by using *Annex A, Correction of Maximum Dry Density and Optimum Moisture for Oversized Particles*. Samples of soil or soil-aggregate mixture are prepared at several moisture contents and compacted into molds of specified size, using manual or mechanical rammers that deliver a specified quantity of compactive energy. The moist masses of the compacted samples are multiplied by the appropriate factor to determine wet density values. Moisture contents of the compacted samples are determined and used to obtain the dry density values of the same samples. Maximum dry density and optimum moisture content for the soil or soil-aggregate mixture is determined by plotting the relationship between dry density and moisture content.

Apparatus

- Mold – Cylindrical mold made of metal with the dimensions shown in Table 1 or Table 2. If permitted by the agency, the mold may be of the “split” type, consisting of two half-round sections, which can be securely locked in place to form a cylinder. Determine the mold volume according to *Annex B, Standardization of the Mold*.
- Mold assembly – Mold, base plate, and a detachable collar.
- Rammer – Manually or mechanically operated rammers as detailed in Table 1 or Table 2. A manually operated rammer shall be equipped with a guide sleeve to control the path and height of drop. The guide sleeve shall have at least four vent holes no smaller than 9.5 mm (3/8 in.) in diameter, spaced approximately 90 degrees apart and approximately 19 mm (3/4 in.) from each end. A mechanically operated rammer will uniformly distribute blows over the sample and will be calibrated with several soil types, and be adjusted, if necessary, to give the same moisture-density results as with the manually operated rammer. For additional information concerning calibration, see AASHTO T 99 and T 180.
- Sample extruder – A jack, lever frame, or other device for extruding compacted specimens from the mold quickly and with little disturbance.
- Balance(s) or scale(s) of the capacity and sensitivity required for the procedure used by the agency.
 - A balance or scale with a capacity of 11.5 kg (25 lb) and a sensitivity of 1 g for obtaining the sample, meeting the requirements of AASHTO M 231, Class G 5.

A balance or scale with a capacity of 2 kg and a sensitivity of 0.1 g is used for moisture content determinations done under both procedures, meeting the requirements of AASHTO M 231, Class G 2.

- Drying apparatus – A thermostatically controlled drying oven, capable of maintaining a temperature of 110 ±5°C (230 ±9°F) for drying moisture content samples in accordance with the FOP for AASHTO T 255/T 265.
- Straightedge – A steel straightedge at least 250 mm (10 in.) long, with one beveled edge and at least one surface plane within 0.1 percent of its length, used for final trimming.
- Sieve(s) – 4.75 mm (No. 4) and/or 19.0 mm (3/4 in.), meeting the requirements of FOP for AASHTO T 27/T 11.
- Mixing tools – Miscellaneous tools such as a mixing pan, spoon, trowel, spatula, etc., or a suitable mechanical device, for mixing the sample with water.
- Containers with close-fitting lids to prevent gain or loss of moisture in the sample.

**Table 1
Comparison of Apparatus, Sample, and Procedure – Metric**

	T 99	T 180
Mold Volume, m ³	Methods A, C: 0.000943 ±0.000014	Methods A, C: 0.000943 ±0.000014
	Methods B, D: 0.002124 ±0.000025	Methods B, D: 0.002124 ±0.000025
Mold Diameter, mm	Methods A, C: 101.60 ±0.40	Methods A, C: 101.60 ±0.4
	Methods B, D: 152.40 ±0.70	Methods B, D: 152.40 ±0.70
Mold Height, mm	116.40 ±0.50	116.40 ±0.50
Detachable Collar Height, mm	50.80 ±0.64	50.80 ±0.64
Rammer Diameter, mm	50.80 ±0.25	50.80 ±0.25
Rammer Mass, kg	2.495 ±0.009	4.536 ±0.009
Rammer Drop, mm	305 ±2	457 ±2
Layers	3	5
Blows per Layer	Methods A, C: 25	Methods A, C: 25
	Methods B, D: 56	Methods B, D: 56
Material Size, mm	Methods A, B: 4.75 minus	Methods A, B: 4.75 minus
	Methods C, D: 19.0 minus	Methods C, D: 19.0 minus
Test Sample Size, kg	Method A: 3 Method C: 5 (1)	Method B: 7 Method D: 11(1)
Energy, kN-m/m ³	592	2,693

(1) This may not be a large enough sample depending on your nominal maximum size for moisture content samples.

**Table 2
Comparison of Apparatus, Sample, and Procedure – English**

	T 99	T 180
Mold Volume, ft ³	Methods A, C: 0.0333 ±0.0005	Methods A, C: 0.0333 ±0.0005
	Methods B, D: 0.07500 ±0.0009	Methods B, D: 0.07500 ±0.0009
Mold Diameter, in.	Methods A, C: 4.000 ±0.016	Methods A, C: 4.000 ±0.016
	Methods B, D: 6.000 ±0.026	Methods B, D: 6.000 ±0.026
Mold Height, in.	4.584 ±0.018	4.584 ±0.018
Detachable Collar Height, in.	2.000 ±0.025	2.000 ±0.025
Rammer Diameter, in.	2.000 ±0.025	2.000 ±0.025
Rammer Mass, lb	5.5 ±0.02	10 ±0.02
Rammer Drop, in.	12 ±0.06	18 ±0.06
Layers	3	5
Blows per Layer	Methods A, C: 25	Methods A, C: 25
	Methods B, D: 56	Methods B, D: 56

	T 99	T 180
Material Size, in.	Methods A, B: No. 4 minus	Methods A, B: No.4 minus
	Methods C, D: 3/4 minus	Methods C, D: 3/4 minus
Test Sample Size, lb	Method A: 7 Method C: 12 ₍₁₎	Method B: 16 Method D: 25 ₍₁₎
Energy, lb-ft/ft ³	12,375	56,250

(1) This may not be a large enough sample depending on your nominal maximum size for moisture content samples.

Sample

If the sample is damp, dry it until it becomes friable under a trowel. Drying may be in air or by use of a drying apparatus maintained at a temperature not exceeding 60°C (140°F). Thoroughly break up aggregations in a manner that avoids reducing the natural size of individual particles.

Obtain a representative test sample of the mass required by the agency by passing the material through the sieve required by the agency. See Table 1 or Table 2 for test sample mass and material size requirements.

In instances where the material is prone to degradation, i.e., granular material, a compaction sample with differing moisture contents should be prepared for each point.

If the sample is plastic (clay types), it should stand for a minimum of 12 hours after the addition of water to allow the moisture to be absorbed. In this case, several samples at different moisture contents should be prepared, put in sealed containers, and tested the next day.

Note 1: Both T 99 and T 180 have four methods (A, B, C, D) that require different masses and employ different sieves.

Procedure

During compaction, rest the mold firmly on a dense, uniform, rigid, and stable foundation, or base. This base shall remain stationary during the compaction process.

1. Determine the mass of the clean, dry mold. Include the base plate but exclude the extension collar. Record the mass to the nearest 1 g (0.005 lb).
2. Thoroughly mix the selected representative sample with sufficient water to dampen it to approximately 4 to 8 percentage points below optimum moisture content. For many materials, this condition can be identified by forming a cast by hand.
 - a. Prepare individual samples of plastic or degradable material, increasing moisture contents 1 to 2 percent for each point.
 - b. Allow samples of plastic soil to stand for 12 hrs.
3. Form a specimen by compacting the prepared soil in the mold assembly in approximately equal layers. For each layer:
 - a. Spread the loose material uniformly in the mold.

Note 2: It is recommended to cover the remaining material with a non-absorbent sheet or damp cloth to minimize loss of moisture.

- b. Lightly tamp the loose material with the manual rammer or other similar device, this establishes a firm surface.
- c. Compact each layer with uniformly distributed blows from the rammer. See Table 1 for mold size, number of layers, number of blows, and rammer specification for the various test methods. Use the method specified by the agency.

- d. Trim down material that has not been compacted and remains adjacent to the walls of the mold and extends above the compacted surface.
4. Remove the extension collar. Avoid shearing off the sample below the top of the mold. The material compacted in the mold should not be over 6 mm (¼ in.) above the top of the mold once the collar has been removed.
5. Trim the compacted soil even with the top of the mold with the beveled side of the straightedge.
6. Clean soil from exterior of the mold and base plate.
7. Determine and record the mass of the mold, base plate, and wet soil to the nearest 1 g (0.005 lb).
8. Determine and record the wet mass (M_w) of the sample by subtracting the mass in Step 1 from the mass in Step 7.
9. Calculate the wet density (ρ_w), in kg/m³ (lb/ft³), by dividing the wet mass by the measured volume (V_m).
10. Extrude the material from the mold. For soils and soil-aggregate mixtures, slice vertically through the center and remove one of the cut faces for a representative moisture content sample. For granular materials, a vertical face will not exist. Take a representative sample ensuring that all layers are represented. This sample must meet the sample size requirements of the test method used to determine moisture content.

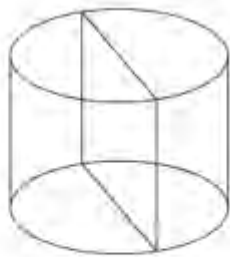

Extruded material



Representative moisture content sample

Note 3: When developing a curve for free-draining soils such as uniform sands and gravels, where seepage occurs at the bottom of the mold and base plate, taking a representative moisture content from the mixing bowl may be preferred in order to determine the amount of moisture available for compaction.

11. Determine and record the moisture content (w) of the sample in accordance with the FOP for AASHTO T 255 / T 265.
12. If the material is degradable or plastic, return to Step 3 using a prepared individual sample. If not, continue with Steps 13 through 15.
13. Thoroughly break up the remaining portion of the molded specimen until it will again pass through the sieve, as judged by eye, and add to the remaining portion of the sample being tested.
14. Add sufficient water to increase the moisture content of the remaining soil by 1 to 2 percentage points and repeat steps 3 through 11.
15. Continue determinations until there is either a decrease or no change in the wet mass. There will be a minimum of three points on the dry side of the curve and two points on the wet side. For non-cohesive, drainable soils, one point on the wet side is sufficient.

Calculations

Wet Density

$$\rho_w = \frac{M_w}{V_m}$$

Where:

ρ_w = wet density, kg/m³ (lb/ft³)

M_w = wet mass

V_m = volume of the mold, Annex B

Dry Density

$$\rho_d = \left(\frac{\rho_w}{w + 100} \right) \times 100 \quad \text{or} \quad \rho_d = \frac{\rho_w}{\left(\frac{w}{100} \right) + 1}$$

Where:

ρ_d = dry density, kg/m³ (lb/ft³)

w = moisture content, as a percentage

Example for 4-inch mold, Methods A or C

Wet mass, M_w	=	1.928 kg (4.25 lb)
Moisture content, w	=	11.3%
Measured volume of the mold, V_m	=	0.000946 m ³ (0.0334 ft ³)

Wet Density

$$\rho_w = \frac{1.928 \text{ kg}}{0.000946 \text{ m}^3} = 2038 \text{ kg/m}^3 \quad \rho_w = \frac{4.25 \text{ lb}}{0.0334 \text{ ft}^3} = 127.2 \text{ lb/ft}^3$$

Dry Density

$$\rho_d = \left(\frac{2038 \text{ kg/m}^3}{11.3 + 100} \right) \times 100 = 1831 \text{ kg/m}^3 \quad \rho_d = \left(\frac{127.2 \text{ lb/ft}^3}{11.3 + 100} \right) \times 100 = 114.3 \text{ lb/ft}^3$$

Or

$$\rho_d = \left(\frac{2038 \text{ kg/m}^3}{\frac{11.3}{100} + 1} \right) = 1831 \text{ kg/m}^3 \quad \rho_d = \left(\frac{127.2 \text{ lb/ft}^3}{\frac{11.3}{100} + 1} \right) = 114.3 \text{ lb/ft}^3$$

Moisture-Density Curve Development

When dry density is plotted on the vertical axis versus moisture content on the horizontal axis and the points are connected with a smooth line, a moisture-density curve is developed. The coordinates of the peak of the curve are the maximum dry density, or just “maximum density,” and the “optimum moisture content” of the soil.

Example

Given the following dry density and corresponding moisture content values develop a moisture-density relations curve and determine maximum dry density and optimum moisture content.

Dry Density		Moisture Content, %
kg/m ³	lb/ft ³	
1831	114.3	11.3
1853	115.7	12.1

1873	116.9	12.8
1869	116.7	13.6
1857	115.9	14.2

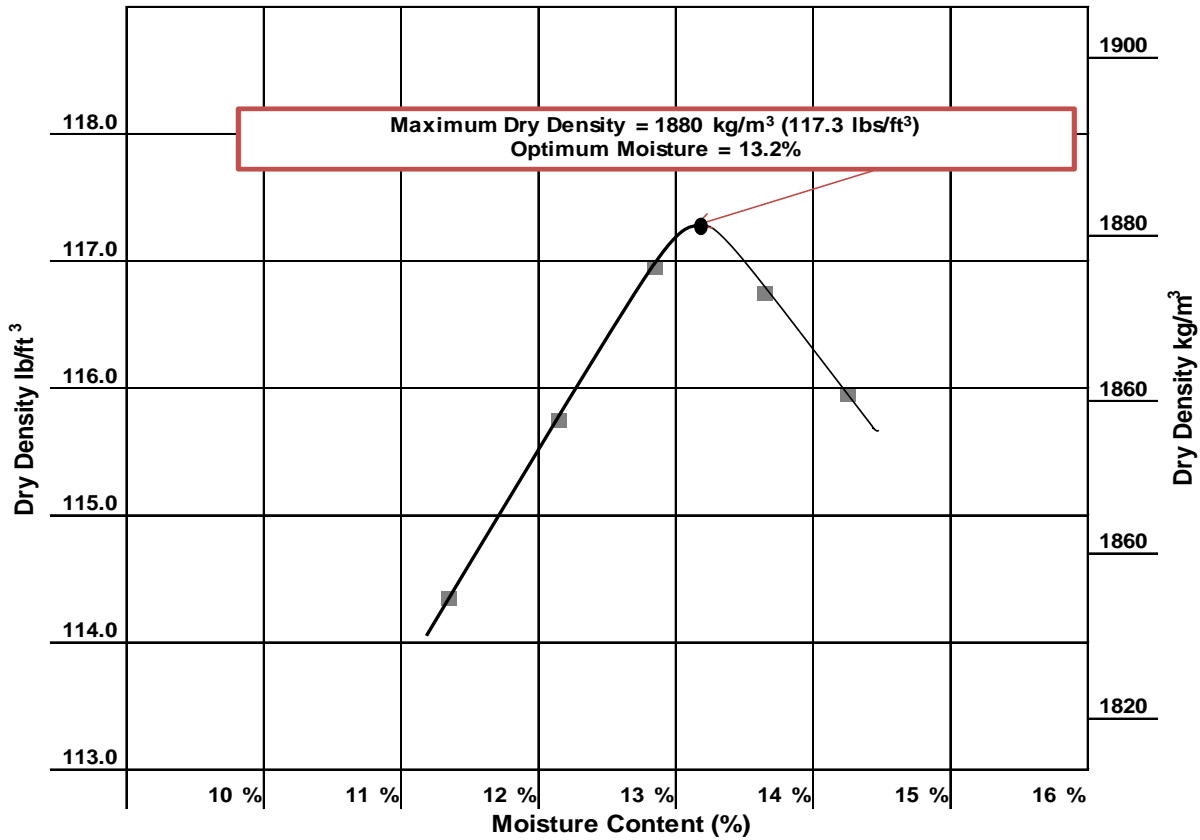

In this case, the curve has its peak at:

Maximum dry density = 1880 kg/m³ (117.3 lb/ft³)
 Optimum moisture content = 13.2%

Note that both values are approximate since they are based on sketching the curve to fit the points.

Report

- Results on forms approved by the agency
- Sample ID
- Maximum dry density to the nearest 1 kg/m³ (0.1 lb/ft³)
- Optimum moisture content to the nearest 0.1 percent

ANNEX A

CORRECTION OF MAXIMUM DRY DENSITY AND OPTIMUM MOISTURE FOR OVERSIZED PARTICLES

(Mandatory Information)

This section corrects the maximum dry density and moisture content of the material retained on the 4.75 mm (No. 4) sieve, Methods A and B; or the material retained on the 19 mm (¾ in.) sieve, Methods C and D. The maximum dry density, corrected for oversized particles and total moisture content, are compared with the field-dry density and field moisture content.

This correction can be applied to the sample on which the maximum dry density is performed. A correction may not be practical for soils with only a small percentage of oversize material. The agency shall specify a minimum percentage below which the method is not needed. If not specified, this method applies when more than 5 percent by weight of oversize particles is present.

Bulk specific gravity (G_{sb}) of the oversized particles is required to determine the corrected maximum dry density. Use the bulk specific gravity as determined using the FOP for AASHTO T 85 in the calculations. For construction activities, an agency established value or specific gravity of 2.600 may be used.

This correction can also be applied to the sample obtained from the field while performing in-place density.

Procedure

1. Use the sample from this procedure or a sample obtained according to the FOP for AASHTO T 310.
2. Sieve the sample on the 4.75 mm (No. 4) sieve for Methods A and B or the 19 mm (¾ in.) sieve, Methods C and D.
3. Determine the dry mass of the oversized and fine fractions (M_{DC} and M_{DF}) by one of the following:
 - a. Dry the fractions, fine and oversized, in air or by use of a drying apparatus that is maintained at a temperature not exceeding 60°C (140°F).
 - b. Calculate the dry masses using the moisture samples.

To determine the dry mass of the fractions using moisture samples.

1. Determine the moist mass of both fractions, fine (M_{Mf}) and oversized (M_{Mc}):
2. Obtain moisture samples from the fine and oversized material.
3. Determine the moisture content of the fine particles (MC_f) and oversized particles (MC_c) of the material by FOP for AASHTO T 255/T 265 or agency approved method.
4. Calculate the dry mass of the oversize and fine particles.

$$M_D = \frac{M_m}{1 + MC}$$

Where:

M_D = mass of dry material (fine or oversize particles)

M_m = mass of moist material (fine or oversize particles)

MC = moisture content of respective fine or oversized, expressed as a decimal

5. Calculate the percentage of the fine (P_f) and oversized (P_c) particles by dry weight of the total sample as follows: See Note 2.

$$P_f = \frac{100 \times M_{DF}}{M_{DF} + M_{DC}} = \frac{100 \times 15.4 \text{ lb}}{15.4 \text{ lbs} + 5.7 \text{ lb}} = 73\% = \frac{100 \times 6.985 \text{ kg}}{6.985 \text{ kg} + 2.585 \text{ kg}} = 73\%$$

And

$$P_c = \frac{100 \times M_{DC}}{M_{DF} + M_{DC}} = \frac{100 \times 5.7 \text{ lb}}{15.4 \text{ lbs} + 5.7 \text{ lb}} = 27\% = \frac{100 \times 2.585 \text{ kg}}{6.985 \text{ kg} + 2.585 \text{ kg}} = 27\%$$

Or for P_c :

$$P_c = 100 - P_f$$

Where:

- P_f = percent of fine particles, of sieve used, by weight
- P_c = percent of oversize particles, of sieve used, by weight
- M_{DF} = mass of dry fine particles
- M_{DC} = mass of dry oversize particles

Optimum Moisture Correction Equation

- Calculate the corrected moisture content as follows:

$$MC_T = \frac{(MC_F \times P_f) + (MC_C \times P_c)}{100} = \frac{(13.2\% \times 73.0\%) + (2.1\% \times 27.0\%)}{100} = 10.2\%$$

MC_T = corrected moisture content of combined fines and oversized particles, expressed as a % moisture

MC_F = moisture content of fine particles, as a % moisture

MC_C = moisture content of oversized particles, as a % moisture

Note 1: Moisture content of oversize material can be assumed to be two (2) percent for most construction applications.

Note 2: In some field applications agencies will allow the percentages of oversize and fine materials to be determined with the materials in the wet state.

Density Correction Equation

- Calculate the corrected dry density (ρ_d) of the total sample (combined fine and oversized particles) as follows:

$$\rho_d = \frac{100\%}{\left[\left(\frac{P_f}{\rho_f} \right) + \left(\frac{P_c}{k} \right) \right]}$$

Where:

- ρ_d = corrected total dry density (combined fine and oversized particles) kg/m^3 (lb/ft^3)
- ρ_f = dry density of the fine particles kg/m^3 (lb/ft^3), determined in the lab
- P_c = percent of dry oversize particles, of sieve used, by weight.
- P_f = percent of dry fine particles, of sieve used, by weight.
- k = Metric: 1,000 * Bulk Specific Gravity (G_{sb}) (oven dry basis) of coarse particles (kg/m^3).
- k = English: 62.4 * Bulk Specific Gravity (G_{sb}) (oven dry basis) of coarse particles (lb/ft^3)

Note 3: If the specific gravity is known, then this value will be used in the calculation. For most construction activities the specific gravity for aggregate may be assumed to be 2.600.

Calculation

Example

- Metric:

Maximum laboratory dry density (ρ_f):	1880 kg/m ³
Percent coarse particles (P _c):	27%
Percent fine particles (P _f):	73%
Mass per volume coarse particles (k):	(2.697) (1000) = 2697 kg/m ³

$$\rho_d = \frac{100\%}{\left[\left(\frac{P_f}{\rho_f}\right) + \left(\frac{P_c}{k}\right)\right]}$$

$$\rho_d = \frac{100\%}{\left[\left(\frac{73\%}{1880 \text{ kg/m}^3}\right) + \left(\frac{27\%}{2697 \text{ kg/m}^3}\right)\right]}$$

$$\rho_d = \frac{100\%}{[0.03883 \text{ kg/m}^3 + 0.01001 \text{ kg/m}^3]}$$

$$\rho_d = 2047.5 \text{ kg/m}^3 \text{ report } 2048 \text{ kg/m}^3$$

- English:

Maximum laboratory dry density (ρ_f):	117.3 lb/ft ³
Percent coarse particles (P _c):	27%
Percent fine particles (P _f):	73%
Mass per volume of coarse particles (k):	(2.697) (62.4) = 168.3 lb/ft ³

$$\rho_d = \frac{100\%}{\left[\left(\frac{P_f}{\rho_f}\right) + \left(\frac{P_c}{k}\right)\right]}$$

$$\rho_d = \frac{100\%}{\left[\left(\frac{73\%}{117.3 \text{ lb/ft}^3}\right) + \left(\frac{27\%}{168.3 \text{ lb/ft}^3}\right)\right]}$$

$$\rho_d = \frac{100\%}{[0.6223 \text{ lb/ft}^3 + 0.1604 \text{ lb/ft}^3]}$$

$$\rho_d = \frac{100\%}{0.7827 \text{ lb/ft}^3}$$

$$\rho_d = 127.76 \text{ lb/ft}^3 \text{ Report } 127.8 \text{ lb/ft}^3$$

Report

- On forms approved by the agency
- Sample ID
- Corrected maximum dry density to the nearest 1 kg/m³ (0.1 lb/ft³)
- Corrected optimum moisture to the nearest 0.1 percent

ANNEX B

STANDARDIZATION OF THE MOLD

(Mandatory Information)

Standardization is a critical step to ensure accurate test results when using this apparatus. Failure to perform the standardization procedure as described herein will produce inaccurate or unreliable test results.

Apparatus

- Mold and base plate
- Balance or scale – Accurate to within 45 g (0.1 lb) or 0.3 percent of the test load, whichever is greater, at any point within the range of use.
- Cover plate – A piece of plate glass, at least 6 mm (1/4 in.) thick and at least 25 mm (1 in.) larger than the diameter of the mold.
- Thermometers – Standardized liquid-in-glass, or electronic digital total immersion type, accurate to 0.5°C (1°F)

Procedure

1. Create a watertight seal between the mold and base plate.
2. Determine and record the mass of the dry sealed mold, base plate, and cover plate.
3. Fill the mold with water at a temperature between 16°C and 29°C (60°F and 85°F) and cover with the cover plate in such a way as to eliminate bubbles and excess water.
4. Wipe the outside of the mold, base plate, and cover plate dry, being careful not to lose any water from the mold.
5. Determine and record the mass of the filled mold, base plate, cover plate, and water.
6. Determine and record the mass of the water in the mold by subtracting the mass in Step 2 from the mass in Step 5.
7. Measure the temperature of the water and determine its density from Table B1, interpolating, as necessary.
8. Calculate the volume of the mold, V_m , by dividing the mass of the water in the mold by the density of the water at the measured temperature.

Calculations

$$V_m = \frac{M}{\rho_{water}}$$

Where:

- V_m = volume of the mold
 M = mass of water in the mold
 ρ_{water} = density of water at the measured temperature

Example

- Mass of water in mold = 0.94367 kg (2.0800 lb)
 ρ_{water} at 23°C (73.4°F) = 997.54 kg/m³ (62.274 lb/ft³)

$$V_m = \frac{0.94367 \text{ kg}}{997.54 \text{ kg/m}^3} = 0.000946 \text{ m}^3 \quad V_m = \frac{2.0800 \text{ lb}}{62.274 \text{ lb/ft}^3} = 0.0334 \text{ ft}^3$$

Table B1
Unit Mass of Water
15°C to 30°C

°C	(°F)	kg/m ³	(lb/ft ³)	°C	(°F)	kg/m ³	(lb/ft ³)
15	(59.0)	999.10	(62.372)	23	(73.4)	997.54	(62.274)
15.6	(60.0)	999.01	(62.366)	23.9	(75.0)	997.32	(62.261)
16	(60.8)	998.94	(62.361)	24	(75.2)	997.29	(62.259)
17	(62.6)	998.77	(62.350)	25	(77.0)	997.03	(62.243)
18	(64.4)	998.60	(62.340)	26	(78.8)	996.77	(62.227)
18.3	(65.0)	998.54	(62.336)	26.7	(80.0)	996.59	(62.216)
19	(66.2)	998.40	(62.328)	27	(80.6)	996.50	(62.209)
20	(68.0)	998.20	(62.315)	28	(82.4)	996.23	(62.192)
21	(69.8)	997.99	(62.302)	29	(84.2)	995.95	(62.175)
21.1	(70.0)	997.97	(62.301)	29.4	(85.0)	995.83	(62.166)
22	(71.6)	997.77	(62.288)	30	(86.0)	995.65	(62.156)

Report

- Mold ID
- Date Standardized
- Temperature of the water
- Volume, V_m , of the mold to the nearest 0.000001 m³ (0.0001 ft³)

This page intentionally left blank.

ATM 211 Density of Soil In-Place by the Sand-Cone Method

1. Scope

This method is a Field Operating Procedure adapted from AASHTO T 191. It is intended for determining the in-place density of soils. The apparatus described herein is restricted to tests in soils containing maximum particle size not larger than 1½ in.

2. Referenced Documents

- WAQTC Standards:
 - FOP for AASHTO T 99/ T 180, Moisture-Density Relations of Soils
 - FOP for AASHTO T 255/ T 265, Total Evaporable Moisture Content of Aggregate by Drying and Laboratory Determination of Moisture Content of Soils
- AASHTO Standards:
 - AASHTO T 19, Bulk Density (“Unit Weight”) and Voids of Aggregate
 - AASHTO T 191, Density of Soil In-Place by the Sand-Cone Method

3. Significance and Use

This method has been created to have an alternate when circumstances make having a nuclear gauge for density testing difficult, if not impossible.

4. Apparatus

- Sand-cone apparatus with base plate conforming to AASHTO T 191
- Sturdy cylindrical container of known volume (V), dimensionally approximate to the largest test hole that will be dug and calibrated according to AASHTO T 19M/T 19.
- Any clean, dry, free-flowing, uncemented sand composed mostly of particles retained on the No. 200 and passing the 2.00-mm (No. 10) sieves. Determine the bulk density from multiple determinations using the same representative sample for each determination. Any sand having a variation in bulk density less than 1 percent is acceptable.
- Balances conforming to the requirements of M 231, one with capacity of at least 16 kg readable to 1g and the other with a capacity of at least 5 kg readable to 0.1g.
- Stove or oven or other suitable equipment for drying moisture content samples
- Containers, clean, dry and capable of being sealed
- Suitable drying containers
- Small pick, chisels, screw drivers and/or spoons for digging test hole

5. Bulk Density of Sand and Cone Correction (C)

1. Fill the apparatus by:
 - a. Place the empty sand-cone apparatus upright on a firm level surface and fill with sand.

Note 1: Appreciable time intervals between the bulk density determination of the sand and its use in the field may result in change in the bulk density caused by a change in the moisture content or effective gradation.

- b. Determine and record the initial mass of the sand-cone apparatus filled with sand (m_i).
2. Determining the bulk density of sand (ρ_b) to be used in the field test.
 - a. Determine the mass of the empty calibration container (m_t).
 - b. Position the calibration container on a clean, level, plane surface. Invert the apparatus and seat the funnel over the calibration container.
 - c. Open the valve fully and keep open until the sand stops flowing .
 - d. Close the valve sharply, and remove the sand-cone apparatus from the calibration container.
 - e. Strike off the sand even with the top of the calibration container being careful to not disturb the sand in the container. Determine the mass of the calibration container and sand (m_f).
 - f. Determine and record the bulk density of the sand (ρ_b) by dividing the mass of the sand needed to fill the calibration container ($m_f - m_t$), by it's volume (V) as determined according to T 19M/T 19.

$$\rho_b = \frac{m_f - m_t}{V}$$

3. Determine the volume of sand required to fill the funnel and base plate (C).
 - a. Fill the sand-cone apparatus, determine and record the mass in accordance with step 1.
 - b. Place the base plate on a clean, level, plane surface. Close the valve and invert the sand-cone apparatus filled with sand and seat the funnel in the recess of the base plate.
 - c. Open the valve fully; allow the sand to flow until the sand stops flowing.
 - d. Close the valve sharply, remove the sand-cone apparatus and determine the final mass of the sand-cone apparatus and the remaining sand (m_f).
 - e. Determine the volume of the cone and base plate (C) by dividing the mass of sand required to fill the cone and base plate ($m_i - m_f$) by the density of the sand (ρ_b). (Note 2).

$$C = \frac{m_i - m_f}{\rho_b}$$

Note 2: For each lot of sand there will be a unique bulk density. If the lot consists of several bags, verify that each bag is within 1% of the lot density. Each sand-cone and matched base plate will also have a unique volume. If more than one sand cone apparatus is available, the sand-cone and base plate should be marked and the associated volume recorded.

6. Procedure

1. Determine the density of the soil in place as follows:
 - a. Fill the sand-cone apparatus with sand. Record the initial mass of the sand and sand-cone apparatus (m_i).
 - b. Fill in surface voids with fines of the material being tested passing the 4.75 mm (No. 4) sieve or finer. Smooth the surface with the base plate or other suitable tool. The depth of the filler should not exceed approximately 3 mm (1/8 in.).
 - c. Place the base plate on the prepared surface and seat. Remove the material from the test hole by digging the soil out, being careful to avoid disturbing the soil that will bound the hole. Soils that are granular require extreme care. Remove all loosened soil and place in a container, being careful to

avoid losing any material. Care must be taken to avoid moisture loss during excavation. The test hole volume must conform to those given in Table 1.

Table 1

Maximum Particle Size		Minimum Test Hole, Volume	
mm	Alternate	cm ³	ft ³
4.75	No. 4	710	0.0250
12.5	½"	1415	0.0500
25.0	1"	2125	0.0750
37.5	1 ½"	2830	0.1000

- d. Close the valve and invert the sand-cone apparatus filled with sand and seat the funnel in the recess of the base plate.
- e. Open the valve fully; allow the sand to flow until the sand stops flowing.
- f. Close the valve sharply, remove the sand-cone apparatus and determine the final mass of the sand-cone apparatus and the remaining sand (m_f).
- g. Determine the final mass of the apparatus with the remaining sand (m_f) and record.
- h. Determine the mass of the moist material that was removed from the test hole.
- i. Mix the material thoroughly and determine the moisture content in accordance with WAQTC FOP for AASHTO T 255/ T 265.

7. Calculation

1. Calculate the volume of the test hole (V_h) to the nearest 0.0001 ft³:

$$V_h = \frac{m_i - m_f}{\rho_b} - C$$

Where:

- V_h = volume of the test hole,
- m_i = initial mass of the apparatus and sand,
- m_f = final mass of the apparatus and sand,
- C = Cone Correction, and
- ρ_b = bulk density of the sand.

2. Determine the dry mass of the material removed from the test hole to the nearest 1 g by either drying the entire sample or calculate as follows:

$$M_d = \frac{M_w}{\left(1 + \left(\frac{w}{100}\right)\right)}$$

Where:

- M_d = dry mass of the material removed from the test hole,
- M_w = moist mass of the material removed from the test hole, and
- w = moisture content of the material removed from the test hole as determined by WAQTC FOP for AASHTO T 255/ T 265.

3. Calculate the in-place dry density of the material removed from the test hole as follows:

$$\rho_d = \frac{M_d}{V_h}$$

Where:

ρ_d = in-place dry density of the material removed from the test hole,
 M_d = dry mass of the material removed from the test hole, and
 V_h = volume of the test hole (from Calculations Step 1)

4. Calculate the in-place dry density to the nearest 0.1 lb/ft³.
5. Calculate the percentage compaction by dividing the in-place dry density by the standard density determined in accordance with WAQTC FOP for AASHTO T 99/ T 180, ATM 212, or ATM 309, and report to the nearest 0.1 percent.

8. Report

Results shall be reported on standard forms approved by the Department. Report the following information:

- Date and location of test.
- Calibration bulk density of the sand
- Identification of the standard density used
- Volume of the test hole, 0.0001 ft³
- In-place dry density, 0.1 lb/ft³
- Percent compaction, 0.1%

ATM 212 Determining the Standard Density of Coarse Granular Materials Using the Vibratory Compactor

1. Scope

This method determines the maximum density values of granular materials for a standard compaction energy. The method accounts for variations in the maximum attainable density of a given material due to fluctuations in gradation.

With the specific gravity and the compacted density of the plus 4.75 mm (no. 4) and the minus 4.75 mm (No. 4) fractions, a chart and/or curve of standard density values versus percent passing the No. 4 sieve can be plotted.

This test method is conducted using the minus 75 mm (3 in) portion of the sample. It applies to free-draining cohesionless materials with the minus 4.75 mm (No. 4) portion of the sample having 10 percent or less passing the 75 μm (No. 200) sieve.

Note 1: The Vibratory Compaction Test was developed for sandy gravels whose fine fraction is non-plastic and highly permeable or free draining. When the fine fraction is primarily a soil with some plasticity and low permeability or not free draining, WAQTC FOP for AASHTO T 99/T 180 will be used. With borderline materials, both tests shall be applied, and the one yielding the highest unit weight value will be used.

2. Apparatus

- A vibratory spring-loaded compactor essentially conforming to specifications that can be obtained from the State Materials Engineer or the Vibratory Table specified in ASTM D4253.
- Standard Mold and base with a piston to fit inside the mold that has a maximum 1.5 mm (1/16 in) clearance between piston and mold.
- A 0.014 m³ (1/2 ft³) mold with a piston to fit inside mold that has a maximum 1.5 mm (1/16 in) clearance between piston and mold.

Note 2: The molds and pistons will be constructed of metal of such dimensions as to remain rigid and inflexible under test conditions.

- Spacer blocks of varying heights compatible with the compactor and pistons.
- Measuring device, accurate and readable to 0.1 mm (0.01 in) with a minimum 150 mm (6 in) length.
- A 75 mm (3 in) and a 4.75 mm (No. 4) sieve conforming to AASHTO M 92 (ASTM E11) requirements.
- Balance or scale: Capacity sufficient for the sample mass, readable to 0.1 percent or 0.1 g and meeting the requirements of AASHTO M 231.

Note 3: The compaction tests require a scale with a capacity of at least 40 kg (90 lb), readable to 5 g (0.01 lb) or better.

Note 4: The moisture content tests require a scale with a capacity of at least 1000 g and readable to 0.1 g or better.

- A 2.5 kg (5.5 lb) metal rammer conforming to the requirements of WAQTC FOP for AASHTO T 99/T 180.
- Tamping rod of straight steel, 16 mm (5/8 in) in diameter and approximately 600 mm (24 in) long having at least one end rounded to a hemispherical tip.
- Graduated cylinder, 1000 ml capacity, readable to 5 ml.
- A stopwatch or timer accurate to 1 second.
- Miscellaneous tools including pans, spoon, trowel, mechanical mixer (optional), etc.

3. Mold Calibration

The following calibration of test apparatus should be performed before initial use and at intervals not exceeding 1000 tests, or annually, whichever occurs first. Additionally, the ATM apparatus or Vibrating Table should be calibrated after any event (including repairs) which might affect its operation.

Molds – Determine the volume of each mold by the water-filling method described below. Enter data and perform calculations on the included worksheet.

1. Measure inside height of cylindrical mold to nearest 0.001 inch at three locations around mold circumference approximately 120 degrees apart and record as (**h₁**, **h₂**, **h₃**).
2. Average the three inside height readings, divide by 12 to convert from inches to feet, and record as (**h**), Average Inside Mold Height (ft). Equation: $h = (h_1 + h_2 + h_3) / (3 \times 12)$
3. Measure thickness of steel top plate, that confines soil in mold, to nearest 0.001 inch at three locations around plate circumference approximately 120 degrees apart and record as (**t₁**, **t₂**, **t₃**).
4. Average the three plate thickness readings and record as (**t**), Average Plate Height.
5. Determine mass of mold, glass cover plate, and any grease or silicone lubricant used on mold rim to make a watertight seal with the glass plate to nearest 0.001 lb Record as (**b**), Mass of Mold + Glass.
6. Fill mold with room temperature water and record water temperature to nearest 0.1^oF under (**d**), Water Temperature.
7. Look up the water density for this temperature in the included "Table 1: Water Density variation with Temperature" and record this density under (**e**), Water Density.
8. Determine mass of mold, water and glass cover plate to nearest 0.001 lb and record as (**a**), Mass of Mold + Glass + Water.
9. Determine Water Mass, (**c**) required to fill mold completely, by subtracting mass of mold and plate (**b**) from mass of mold, plate, and water (**a**). Equation: $c = a - b$
10. Calculate Mold Volume (**f**). Density = Mass / Volume. Solving for Volume gives: Volume = Mass / Density. The Volume of water contained = Mold Volume. Equation: $f = c / e$
11. Calculate Mold Cross-Sectional Area (**g**). Volume of a cylinder = Area of base x Height, (or Mold Cross-Sectional Area x Height). Solving for Mold Cross-Sectional Area gives:

Mold Cross-Sectional Area = Volume / Height. Equation: $g = f / h$

CALIBRATION DATA & CALCULATIONS	Formulae	Data and Calculations		
		h ₁ (in)	h ₂ (in)	h ₃ (in)
h. Mold Inside Height Readings (in)				
Average Height (ft)	$(h_1+h_2+h_3)/36$			
a. Mass of Mold + Glass + Water (lb)				
b. Mass of Mold + Glass (lb)				
c. Water Mass (lb)	$c = a - b$			
d. Water Temperature (°C)				
e. Water Density (lbm/ft ³ at temp d)				
f. Water Volume = Mold Volume (ft ³)	$f = c/e$			
g. Mold Cross-Sectional Area (ft ²)	$g = f/h$			
		t ₁ (in)	t ₂ (in)	t ₃ (in)
t. Top Plate Thickness Readings (in)				
Average Thickness (ft)	$(t_1+t_2+t_3)/36$			

Table 1: Water Density variation with Temperature								
Temp	Water Density, ρ		Temp	Water Density, ρ		Temp	Water Density, ρ	
⁰ C	g/cm ³	lbm/ft ³	⁰ C	g/cm ³	lbm/ft ³	⁰ C	g/cm ³	lbm/ft ³
15.0	0.9991016	62.37187	20.0	0.9982063	62.31598	25.0	0.9970480	62.24367
15.1	0.9990864	62.37092	20.1	0.9981856	62.31469	25.1	0.9970223	62.24206
15.2	0.9990712	62.36997	20.2	0.9981649	62.31339	25.2	0.9969965	62.24045
15.3	0.9990558	62.36901	20.3	0.9981440	62.31209	25.3	0.9969707	62.23884
15.4	0.9990403	62.36804	20.4	0.9981230	62.31078	25.4	0.9969447	62.23722
15.5	0.9990247	62.36707	20.5	0.9981019	62.30946	25.5	0.9969186	62.23559
15.6	0.9990090	62.36609	20.6	0.9980807	62.30814	25.6	0.9968925	62.23396
15.7	0.9989932	62.36510	20.7	0.9980594	62.30681	25.7	0.9968663	62.23233
15.8	0.9989772	62.36411	20.8	0.9980380	62.30547	25.8	0.9968399	62.23068
15.9	0.9989612	62.36311	20.9	0.9980164	62.30412	25.9	0.9968135	62.22903
16.0	0.9989450	62.36209	21.0	0.9979948	62.30278	26.0	0.9967870	62.22738
16.1	0.9989287	62.36108	21.1	0.9979731	62.30142	26.1	0.9967604	62.22571
16.2	0.9989123	62.36005	21.2	0.9979513	62.30006	26.2	0.9967337	62.22405
16.3	0.9988957	62.35902	21.3	0.9979294	62.29869	26.3	0.9967069	62.22237
16.4	0.9988791	62.35798	21.4	0.9979073	62.29731	26.4	0.9966800	62.22070
16.5	0.9988623	62.35693	21.5	0.9978852	62.29593	26.5	0.9966530	62.21901
16.6	0.9988455	62.35588	21.6	0.9978630	62.29455	26.6	0.9966259	62.21732
16.7	0.9988285	62.35482	21.7	0.9978406	62.29315	26.7	0.9965987	62.21562
16.8	0.9988114	62.35375	21.8	0.9978182	62.29175	26.8	0.9965714	62.21392
16.9	0.9987942	62.35268	21.9	0.9977957	62.29035	26.9	0.9965441	62.21221
17.0	0.9987769	62.35160	22.0	0.9977730	62.28893	27.0	0.9965166	62.21049
17.1	0.9987595	62.35051	22.1	0.9977503	62.28751	27.1	0.9964891	62.20878
17.2	0.9987419	62.34942	22.2	0.9977275	62.28609	27.2	0.9964615	62.20706
17.3	0.9987243	62.34832	22.3	0.9977045	62.28465	27.3	0.9964337	62.20532
17.4	0.9987065	62.34721	22.4	0.9976815	62.28322	27.4	0.9964059	62.20358
17.5	0.9986886	62.34609	22.5	0.9976584	62.28178	27.5	0.9963780	62.20184
17.6	0.9986706	62.34496	22.6	0.9976351	62.28032	27.6	0.9963500	62.20009
17.7	0.9986525	62.34383	22.7	0.9976118	62.27887	27.7	0.9963219	62.19834
17.8	0.9986343	62.34270	22.8	0.9975883	62.27740	27.8	0.9962938	62.19659
17.9	0.9986160	62.34156	22.9	0.9975648	62.27593	27.9	0.9962655	62.19482
18.0	0.9985976	62.34041	23.0	0.9975412	62.27446	28.0	0.9962371	62.19305
18.1	0.9985790	62.33925	22.1	0.9975174	62.27297	28.1	0.9962087	62.19127
18.2	0.9985604	62.33809	23.2	0.9974936	62.27149	28.2	0.9961801	62.18949
18.3	0.9985416	62.33691	23.3	0.9974697	62.26999	28.3	0.9961515	62.18770
18.4	0.9985228	62.33574	23.4	0.9974456	62.26849	28.4	0.9961228	62.18591
18.5	0.9985038	62.33455	23.5	0.9974215	62.26699	28.5	0.9960940	62.18411
18.6	0.9984847	62.33336	23.6	0.9973973	62.26548	28.6	0.9960651	62.18231
18.7	0.9984655	62.33216	23.7	0.9973730	62.26396	28.7	0.9960361	62.18050
18.8	0.9984462	62.33096	23.8	0.9973485	62.26243	28.8	0.9960070	62.17868
18.9	0.9984268	62.32974	23.9	0.9973240	62.26090	28.9	0.9959778	62.17686
19.0	0.9984073	62.32853	24.0	0.9972994	62.25936	29.0	0.9959486	62.17504
19.1	0.9983877	62.32730	24.1	0.9972747	62.25782	29.1	0.9959192	62.17320
19.2	0.9983680	62.32607	24.2	0.9972499	62.25627	29.2	0.9958898	62.17137
19.3	0.9983481	62.32483	24.3	0.9972250	62.25472	29.3	0.9958603	62.16952
19.4	0.9983282	62.32359	24.4	0.9972000	62.25316	29.4	0.9958306	62.16767
19.5	0.9983081	62.32233	24.5	0.9971749	62.25159	29.5	0.9958009	62.16582
19.6	0.9982880	62.32108	24.6	0.9971497	62.25002	29.6	0.9957712	62.16396
19.7	0.9982677	62.31981	24.7	0.9971244	62.24844	29.7	0.9957413	62.16209
19.8	0.9982474	62.31855	24.8	0.9970990	62.24685	29.8	0.9957113	62.16022
19.9	0.9982269	62.31727	24.9	0.9970735	62.24526	29.9	0.9956813	62.15835

4. Sample Preparation

1. Sample the material in accordance with WAQTC FOP for AASHTO T 2 (ASTM D75). Initially prepare the field sample by splitting out representative portions in accordance with WAQTC FOP for AASHTO T 248, Method A, to provide sufficient material for the following tests:
 - a. Retain an as-received compaction sample of approximately 20 kg (45 lb) to be used if verification of the end result "Maximum Dry Density vs. the Percent Passing 4.75 mm (No. 4) Sieve" curve is needed. (See Section 11, Supplementary Requirement.)
 - b. Sieve Analysis in accordance with WAQTC FOP for AASHTO T 27/T 11.
 - c. Coarse Aggregate Apparent Specific Gravity in accordance with WAQTC FOP for AASHTO T 85.
 - d. Fine Aggregate Apparent Specific Gravity in accordance with AASHTO T 84 or AASHTO T100.
 - e. Compaction sample to provide sufficient material for the compaction specimens detailed below.
2. Dry the compaction sample to constant mass in accordance with the aggregate section of WAQTC FOP for AASHTO T 255/ T 265.
3. Scalp the plus 75 mm (3 in) material from the compaction sample (e.) and discard, if not needed for any other tests. Separate the remainder of the compaction sample into coarse [minus 75 mm (3 in) to 4.75 mm (No. 4)] and fine [minus 4.75 mm (No. 4)] aggregate fractions.
4. The quantity of material necessary to complete tests on both fractions is:
 - a. Fine aggregate, minimum of 3 portions approximately 6 kg (13 lb) each.
 - b. Coarse aggregate:
 - 1) For material containing 5 percent or less of 19.0 mm (3/4 in) material, a portion of the minus 19.0 mm (3/4 in) aggregate of approximately 6 kg (13 lb).
 - 2) For material containing more than 5 percent plus 19.0 mm (3/4 in) aggregate a portion of 18 to 20 kg (40 to 45 lb).

5. Procedure

1. Compaction Test of the Fine Fraction:
 - a. Assemble the Standard Mold and determine its mass, along with the Piston, to the nearest 5 g (0.01 lb). Record this as the Mass of Mold Assembly.
 - b. Using one of the fine aggregate portions, add an amount of water estimated to produce a saturated sample when compacted and mix thoroughly.
 - 1) When the material is at its saturation point, free water (a drop or two) will show at the base of the mold at about the 227 kg (500 lb) load of the first compression run. The ideal saturation point would be a bead of water around the base of the mold at the end of the 10-minute compaction run. Most materials will yield the highest density at that moisture content. Some materials may continue to gain density at higher moisture contents; however, this is due to the washing out of fines, which will alter the character of the sample. Therefore, if severe washing-out or pumping of fines occurs (as evidenced by dirty water flooding off of the base or pumped on top of the piston), the sample is beyond the saturation point, will be discarded and a lower moisture content tried for the saturation point.
 - 2) Moisture contents beyond the saturation point need not be tested.

- c. Set the piston aside and place the sample in the mold in three approximately equal layers. Consolidate each lift by 25 strokes of the tamping rod followed by 25 blows of the manual rammer. If severe displacement of the material occurs, adjust the blow strength by limiting the height of each blow to produce the maximum compaction and minimum displacement. The surface of the top lift should be finished as level as possible.
- d. Place the piston on top of the sample and mount the mold on the jack platform in the compactor. Spacers between the load spring and piston must be used to adjust the elevation of the mold so the hammers strike the mold in the center of the lift area. Elevate the mold until the loading head seats on top of the piston. Apply an initial seating load of approximately 45 kg (100 lbs) on the sample.
- e. Start the vibratory hammers and, by elevating the jack, begin the loading application rate procedure.

The load application rate to 2000 lbs. is applied as follows:

Load	Elapsed Time
0 to 225 kg (500 lb)	1 minute
225 kg to 450 kg (1000 lb)	1-1/2 minutes
450 kg to 900 kg (2000 lb)	2 minutes

- f. Upon reaching the 900 kg (2000 lb) load at the end of the 2-minute cycle, stop the hammers, release the load on the jack, and return to zero pressure.
 - g. Repeat Steps (e) and (f) four additional times. After the last run remove the mold from the compactor.
 - h. Measure the height of the compacted sample, to the top of the piston, to the nearest 0.1 mm (0.01 in) by measuring from the top of the mold to the surface of the sample at a minimum of 4 different places evenly spaced around the circumference of the mold. Record and average these measurements. Subtract this average from the overall height of the mold and record as the Height of Sample.
 - i. Determine the mass of the specimen in the mold to the nearest 5 g (0.01 lb). Record this as Mass of Mold Assembly + Aggregate.
 - j. Remove the specimen from the mold and determine the moisture content in accordance with WAQTC FOP for AASHTO T 255, recording the data on the Vibratory Compaction Worksheet.
 - k. Repeat Steps (b) thru (j) at lower or higher moisture content increments of approximately 1 percent intervals to determine the maximum density value for the material. Three tests are usually sufficient.
2. Compaction Test of the Coarse Fraction:
- a. For minus 19 mm (3/4 in) aggregates:
 - 1) Determine the mass of the coarse aggregate to the nearest 5 g (0.01 lb). Record this mass as Net Mass of Coarse Aggregate.
 - 2) Add 2.5 percent moisture to the sample, mix thoroughly and place in the Standard CBR mold in approximately three equal lifts. Compact each lift with 25 blows of the tamping rod (omit hammering). Avoid the loss of any material during this operation, or the net mass of coarse aggregate must be determined again, after determining the height of the sample and drying the material to constant mass.
 - 3) Follow the procedures outlined in Steps 5.1.d. through 5.1.h.
 - b. For plus 19 mm (3/4 in) aggregates:
 - 1) Determine the mass of the coarse aggregate to the nearest 5 g (0.01 lb) or better. Record this mass the Net Mass of Coarse Aggregate.

- 2) Divide the sample into three representative and approximately equal portions.
- 3) Place one of the portions into the 0.014 m³ (1/2 ft³) mold. Level the surface by hand and consolidate the layer with 25 strokes of the tamping rod, using the rounded end. Distribute the strokes evenly over the entire cross section of the material rodding full depth, if possible, without hitting the bottom too hard.
- 4) Repeat this procedure for the other lifts, penetrating, if possible, into the lower layer. Avoid the loss of any material during this operation, or the net mass of coarse aggregate must be re-determined after determining the height of the sample. Position the piston on the sample, mount the mold in the compactor and follow the procedure described in Steps 5.1.d. through 5.1.h.

6. Calculations

Calculate the dry density of each of the fine and coarse aggregate fractions following steps 1-17 below. The maximum dry density for the fine aggregate fraction is the highest density at or below the saturation point.

1. Enter mold inside height (**a**) from current mold calibration form.
2. Enter mold cross-sectional area (**b**) from current mold calibration form.
3. Enter thickness of steel top plate (**c**), that confines aggregate in mold, from current mold calibration form.
4. Determine mass of empty mold and top plate (**d**) to nearest 0.001 lb.
5. Determine mass of mold + aggregate + top plate (**e**) to nearest 0.001 lb.
6. Subtract mass of empty mold and top plate (**d**) from aggregate filled mold assembly (**e**) to get mass of aggregate (**f**). Equation: **f = e - d**.
7. After compaction take four height measurements from top of mold to top of plate, approximately 90 degrees apart, record as (**d**₁, **d**₂, **d**₃, **d**₄), then average the four values and convert to feet (**g**). Equation: **g = (d₁ + d₂ + d₃ + d₄) / (4 x 12)**.
8. Subtract distance from top of mold to top plate (**g**) + thickness of top plate (**c**) from mold height (**a**) to get height of aggregate (**h**). Equation: **h = a - c - g**.
9. Calculate aggregate volume (**i**) by multiplying mold cross-sectional area (**b**) by the aggregate height (**h**). Equation: **i = (b)(h)**.
10. Calculate Wet Density of Compacted Aggregate (**j**) by dividing aggregate mass (**f**) by aggregate volume (**i**). Equation: **j = f/i**.
11. Determine the tare mass (**k**) of pan to be used for a wet aggregate moisture test.
12. Remove the wet aggregate from the mold and immediately record mass of tare and representative moisture sample (**l**).
13. Dry moisture sample to constant mass and record mass of dry aggregate and tare (**m**).
14. Calculate Dry Aggregate mass (**n**). Equation: **n = m - k**.
15. Calculate Water mass (**o**). Equation: **o = l - m**.
16. Calculate decimal fraction of water in aggregate (**p**). Equation: **p = o/n**.
17. Calculate Dry Density of Compacted Aggregate (**q**). Equation: **q = j/(1 + p)**.
18. Determine the apparent specific gravity of the fine aggregate in accordance with AASHTO T 84.

19. Determine the apparent specific gravity of the coarse aggregate in accordance with WAQTC FOP for AASHTO T 85.
20. Plotting the "Maximum Dry Density vs. the Percent Passing 4.75 mm (No. 4) Sieve" curve is based on complex theoretical formulae. Programs for solution of these formulae, which produce curve data points and charts, have been developed for spreadsheets. These programs are available from the Statewide/Regional laboratories.

TEST DATA & CALCULATIONS:	Formulae	Data			
a. Mold Inside Height (ft)					
b. Mold Cross-Sectional Area (ft ²)					
c. Top Plate Thickness (ft)					
d. Mass Empty Mold + Top Plate (lb)					
e. Mass Mold + Aggregate + Top Plate (lb)					
f. Mass of Compacted Aggregate (lb)	$f = e - d$				
		d ₁ (in)	d ₂ (in)	d ₃ (in)	d ₄ (in)
Distance, top of mold to plate (in)					
g. Average Distance (ft)	$g = (d_1+d_2+d_3+d_4)/48$				
h. Height of Compacted Aggregate (ft)	$h = a - c - g$				
i. Volume of Compacted Aggregate (ft ³)	$i = (b)(h)$				
j. Compacted Aggregate Wet Density (lb/ft ³)	$j = f/i$				
Moisture Content of Aggregate:					
k. Tare mass (g)					
l. Wet Aggregate + Tare (g)					
m. Dry Aggregate + Tare (g)					
n. Dry Aggregate mass (g)	$n = m - k$				
o. Water mass (g)	$o = l - m$				
p. Decimal Fraction of Water in Aggregate	$p = o/n$				
q. Compacted Aggregate Dry Density (lb/ft ³)	$q = j/(1+p)$				

7. Report

- Results on forms approved by the Department
- Standard Conformance tests for the material
- Maximum dry density in chart form to the nearest 1 kg/m³ (0.1 lb/ft³) vs. the Percent Passing 4.75 mm (No. 4) in whole percentages from 0 to 100 percent.
- The data may be displayed graphically in addition to the chart.

8. Supplementary Requirement

The following supplementary requirement shall apply only when specified, or when required by the Regional Quality Assurance or Materials Engineer.

1. Using the sample obtained in Step 4.1.a., adjust its moisture content to optimum as determined by the following:

$$MC_t = \frac{(MC_f \times P_f) + (MC_c \times P_c)}{100}$$

Where:

- MC_t = total moisture content of combined fine and coarse fractions, expressed as a % moisture
- MC_f = moisture content of the fine fraction corresponding to the maximum dry density determined in Step 6.1.d., expressed as a % moisture
- P_f = percent fine fraction determined from original gradation, in Step 4.1.b.
- MC_c = moisture content of the coarse fraction when Step 5.2 was performed, expressed as a % moisture (if moisture was not used, two (2) percent can be assumed)
- P_c = percent coarse fraction determined from original gradation, in Step 4.1.b.

2. Compact the sample per Step 5.2.b.
3. Determine maximum dry density of the sample per Step 6.17
4. Plot the sample point on the graph containing the “Maximum Dry Density vs. the Percent Passing 4.75 mm (No. 4) sieve” curve generated in Step 6.20.
5. If the sample point falls more than 4 pcf below (or above) the point on the curve corresponding to its respective FA percentage then produce 2-4 additional CA/FA blends spaced evenly through the range of gradation. Compact these points per Step 5.2.b. Plot this series of dry densities at their respective FA percentages and draw a best-fit curve through the points to establish the compaction curve.

ATM 213 In-Place Density and Moisture Content of Soil and Soil-Aggregate by Nuclear Methods (Shallow Depth)

Following are guidelines for the use of WAQTC FOP for AASHTO T 310 by the State of Alaska DOT&PF.

1. The procedure designated as Method A will be used.
2. Report percent compaction to the nearest whole percent.
3. The visual description of the material will be the material classification, i.e. Borrow, D-1, etc.
4. A representative sample of material is required from beneath the gauge for purposes of: verification of moisture content for nuclear gauge according to ATM 213; correcting the Standard Density determined by ATM 207, Annex A, when greater than 5% coarse particles are present; and determining the minus No. 4 for ATM 212.

A sample of material will not be required when any one of the following conditions applies:

- a. The Standard Density is determined by ATM 212 or ATM 215, and the test meets the minimum density requirement using the maximum density from the peak of the curve.
 - b. The Project Engineer may waive this requirement when testing top layer of surface or base course and the Standard Density is determined using ATM 207. In this case, the percent coarse (oversized) for calculating the corrected density is established from proctor gradation of the material being tested.
 - c. A sample is not required for moisture content when the nuclear gauge moisture has been determined to be within 1% of the oven dry moisture and is verified at least every 90 days.
5. The offset factor (k) shall be used to correct the moisture content reading from the gauge.

THE OFFSET FACTOR IS GAUGE-SPECIFIC AND MATERIAL-SPECIFIC and must be established for each gauge and material type tested.

5. Determine the offset factor (k) by:
 5. Average minimum five gauge derived moisture contents.
 5. Average minimum five moisture contents determined by ATM 202, taken from the locations used to determine the gauge derived moistures.
 5. Calculate the offset factor (k) using the following formula.

$$k = \left(\frac{\% M_{\text{Lab}} - \% M_{\text{Gauge}}}{100 + \% M_{\text{Gauge}}} \right) \times 1000$$

5. Follow the gauge Manufacturer's instructions to enable the offset function to correct the moisture reading.
5. Be sure to disengage the offset function upon completion of test.

Note: This procedure is set up for Troxler gauges.

6. When allowed by the Project Engineer, a standard density value may be developed using a one point proctor compacted in accordance with ATM 207, or ATM 309.
7. When the Standard Density is determined using ATM 309, use the average of the tests performed according to ATM 213, taken at three separate random test locations, as the acceptance test value.

8. For “Procedure step 9, Replace “Pull gently on the gauge” with “Pull gently on the base of the gauge”
9. Delete “Procedure” Step 10.a and replace with:
 9. Method A Single Direction: Take a test consisting of the average of two one minute readings, or one four minute reading, and record both density and moisture data. When performing two one minute readings, the two wet density readings should be within 32 kg/m^3 (2.0 lb/ft^3) of each other. The average of the two wet densities and moisture contents will be used to compute dry density. When performing one four minute reading the gauge will average four one minute readings.
10. Delete section “Percent Compaction” and replace with:

Percent Compaction

Percent compaction is determined by comparing the in-place dry density as determined by this procedure to the maximum dry density of the appropriate Standard Density curve.

For plastic or cohesive soil or soil-aggregate mixes, develop the Standard Density curve using the FOP for AASHTO T 99/T 180. When using curves developed by the FOP for AASHTO T 99 / T 180, it may be necessary to use Annex A from FOP for AASHTO T 99/T 180 and FOP for AASHTO T 272 to determine the corrected maximum dry density and optimum moisture.

For non-plastic coarse granular materials, develop the Standard Density curve using ATM 212 to determine maximum dry density and optimum moisture. Maximum dry density values may also be determined by ATM 309 or ASTM D425.

11. Density measured using a low activity nuclear densometer used per ASTM D8167 Standard Test Method for In-Place Bulk Density of Soil and Soil Aggregate by a Low Activity Nuclear Method (Shallow Depth) is an approved alternate to this method.

IN-PLACE DENSITY AND MOISTURE CONTENT OF SOIL AND SOIL-AGGREGATE BY NUCLEAR METHODS (SHALLOW DEPTH)

FOP FOR AASHTO T 310

Scope

This procedure covers the determination of density, moisture content, and relative compaction of soil, aggregate, and soil-aggregate mixes in accordance with AASHTO T 310-22. This procedure provides a rapid, nondestructive technique for determining the in-place wet density and moisture content of soil, aggregate, and soil-aggregate mixes. This field operating procedure is derived from AASHTO T 310. The nuclear moisture-density gauge is used in the direct transmission mode.

Apparatus

- Nuclear density gauge with the factory matched standard reference block.
- Drive pin, guide/scrapper plate, and hammer for testing in direct transmission mode.
- Transport case for properly shipping and housing the gauge and tools.
- Instruction manual for the specific make and model of gauge.
- Radioactive materials information and calibration packet containing:
 - Daily Standard Count Log.
 - Factory and Laboratory Calibration Data Sheet.
 - Leak Test Certificate.
 - Shippers Declaration for Dangerous Goods.
 - Procedure Memo for Storing, Transporting and Handling Nuclear Testing Equipment.
 - Other radioactive materials documentation as required by local regulatory requirements.
- Sealable containers and utensils for moisture content determinations.

Radiation Safety

This method does not purport to address all of the safety problems associated with its use. This test method involves potentially hazardous materials. The gauge utilizes radioactive materials that may be hazardous to the health of the user unless proper precautions are taken. Users of this gauge must become familiar with the applicable safety procedures and governmental regulations. All operators will be trained in radiation safety prior to operating nuclear density gauges. Some agencies require the use of personal monitoring devices such as a thermoluminescent dosimeter or film badge. Effective instructions together with routine safety procedures such as source leak tests, recording and evaluation of personal monitoring device data, etc., are a recommended part of the operation and storage of this gauge.

Calibration

Calibrate the nuclear gauge as required by the agency. This calibration may be performed by the agency using manufacturer's recommended procedures or by other facilities approved by the agency. Verify or re-establish calibration curves, tables, or equivalent coefficients every 12 months.

Standardization

1. Turn the gauge on and allow it to stabilize (approximately 10 to 20 minutes) prior to standardization. Leave the power on during the day's testing.
2. Standardize the nuclear gauge at the construction site at the start of each day's work and as often as deemed necessary by the operator or agency. Daily variations in standard count shall not exceed the daily variations established by the manufacturer of the gauge. If the daily variations are exceeded after repeating the standardization procedure, the gauge should be repaired and/or recalibrated.
3. Record the standard count for both density and moisture in the Daily Standard Count Log. The exact procedure for standard count is listed in the manufacturer's Operator's Manual.

Note 1: New standard counts may be necessary more than once a day. See agency requirements.

Overview

There are two methods for determining in-place density of soil / soil aggregate mixtures. See agency requirements for method selection.

- Method A Single Direction
- Method B Two Direction

Procedure

1. Select a test location(s) randomly and in accordance with agency requirements. Test sites should be relatively smooth and flat and meet the following conditions:
 - a. At least 10 m (30 ft) away from other sources of radioactivity
 - b. At least 3 m (10 ft) away from large objects
 - c. The test site should be at least 150 mm (6 in.) away from any vertical projection.
 - d. Correct for trench wall effect according to manufacturer's correction procedures if the test site is closer than 600 mm (24 in.) to vertical projection. See Note 2.

Note 2: To perform moisture and density tests in a trench or against a large solid object, it is necessary to perform a trench offset correction to adjust the gauge, or it may read a falsely high moisture content. Moisture present in the walls can thermalize neutrons which return to the gauge and are read as moisture by the detector in the gauge.

2. Remove all loose and disturbed material and remove additional material as necessary to expose the top of the material to be tested.
3. Prepare a flat area sufficient in size to accommodate the gauge. Plane the area to a smooth condition so as to obtain maximum contact between the gauge and the material being tested. For Method B, the flat area must be sufficient to permit rotating the gauge 90 or 180 degrees about the source rod.
4. Fill in surface voids beneath the gauge with fines of the material being tested passing the 4.75 mm (No. 4) sieve or finer. Smooth the surface with the guide plate or other suitable tool. The depth of the filler should not exceed approximately 3 mm (1/8 in.).

5. Make a hole perpendicular to the prepared surface using the guide plate and drive pin. The hole shall be at least 50 mm (2 in.) deeper than the desired source rod depth and shall be aligned such that insertion of the source rod will not cause the gauge to tilt from the plane of the prepared area. Remove the drive pin by pulling straight up and twisting the extraction tool.
6. Place the gauge on the prepared surface so the source rod can enter the hole without disturbing loose material.
7. Lower the source rod into the hole to the desired test depth using the handle and trigger mechanism.
8. Seat the gauge firmly by partially rotating it back and forth about the source rod. Ensure the gauge is seated flush against the surface by pressing down on the gauge corners and making sure that the gauge does not rock.
9. Pull gently on the gauge to bring the side of the source rod nearest to the scaler / detector firmly against the side of the hole.
10. Perform one of the following methods, per agency requirements:
 - a. Method A Single Direction: Take a test consisting of the average of two, one-minute readings, and record both density and moisture data. The two wet density readings should be within 32 kg/m^3 (2.0 lb/ft^3) of each other. The average of the two wet densities and moisture contents will be used to compute dry density.
 - b. Method B Two Direction: Take a one-minute reading and record both density and moisture data. Rotate the gauge 90 or 180 degrees, pivoting it around the source rod. Reseat the gauge by pulling gently on the gauge to bring the side of the source rod nearest to the scaler/detector firmly against the side of the hole and take a one-minute reading. (In trench locations, rotate the gauge 180 degrees for the second test.) Some agencies require multiple one-minute readings in both directions. Analyze the density and moisture data. A valid test consists of wet density readings in both gauge positions that are within 50 kg/m^3 (3.0 lb/ft^3). If the tests do not agree within this limit, move to a new location. The average of the wet density and moisture contents will be used to compute dry density.
11. If required by the agency, obtain a representative sample of the material, 4 kg (9 lb) minimum, from directly beneath the gauge full depth of material tested. This sample will be used to verify moisture content and / or identify the correct density standard. Immediately seal the material to prevent loss of moisture.

The material tested by direct transmission can be approximated by a cylinder of soil approximately 300 mm (12 in.) in diameter directly beneath the centerline of the radioactive source and detector. The height of the cylinder will be approximately the depth of measurement. When organic material or large aggregate is removed during this operation, disregard the test information, and move to a new test site.
12. To verify the moisture content from the nuclear gauge, determine the moisture content with a representative portion of the material using the FOP for AASHTO T 255/T 265 or other agency approved methods. If the moisture content from the nuclear gauge is within ± 1 percent, the nuclear gauge readings can be accepted. Moisture content verification is gauge and material specific. Retain the remainder of the sample at its original moisture content for a one-point compaction test under the FOP for AASHTO T 272, or for gradation, if required.

Note 3: Example: A gauge reading of 16.8 percent moisture and an oven dry of 17.7 percent are within the ± 1 percent requirement. Moisture correlation curves will be developed according to agency guidelines. These curves should be reviewed and possibly redeveloped every 90 days.
13. Determine the dry density by one of the following.

- a. From nuclear gauge readings, compute by subtracting the mass (weight) of the water (kg/m^3 or lb/ft^3) from the wet density (kg/m^3 or lb/ft^3) or compute using the percent moisture by dividing wet density from the nuclear gauge by 1 plus the moisture content expressed as a decimal.
- b. When verification is required and the nuclear gauge readings cannot be accepted, the moisture content is determined by the FOP for AASHTO T 255/T 265 or other agency approved methods. Compute dry density by dividing wet density from the nuclear gauge by 1 plus the moisture content expressed as a decimal.

Percent Compaction

Percent compaction is determined by comparing the in-place dry density as determined by this procedure to the appropriate agency density standard. For soil or soil-aggregate mixes, these are moisture-density curves developed using the FOP for AASHTO T 99/T 180. When using maximum dry densities from the FOP for AASHTO T 99/T 180 or FOP for AASHTO T 272, it may be necessary to use the Annex in the FOP for T 99/T 180 to determine corrected maximum dry density and optimum moisture content.

For coarse granular materials, the density standard may be density-gradation curves developed using a vibratory method such as AKDOT&PF's ATM 212, ITD's T 74, **WAQTC TM 15**, or WFLHD's Humphres.

See appropriate agency policies for use of density standards.

Calculation

Calculate the dry density as follows:

$$\rho_d = \left(\frac{\rho_w}{w + 100} \right) \times 100 \quad \text{or} \quad \rho_d = \frac{\rho_w}{\frac{w}{100} + 1}$$

Where:

ρ_d = Dry density, kg/m³ (lb/ft³)

ρ_w = Wet density, kg/m³ (lb/ft³)

w = Moisture content from the FOP's for AASHTO T 255 / T 265, as a percentage

Calculate percent compaction as follows:

$$\% \text{ Compaction} = \frac{\rho_d}{\text{Agency density standard}} \times 100$$

Where:

ρ_d = Dry density, kg/m³ (lb/ft³)

Agency density standard = Corrected maximum dry density from the FOP from T 99/T 180 Annex

Example:

Wet density readings from gauge: 1948 kg/m³ (121.6 lb/ft³)

1977 kg/m³ (123.4 lb/ft³)

Avg: 1963 kg/m³ (122.5 lb/ft³)

Moisture readings from gauge: 14.2% and 15.4% = Avg 14.8%

Moisture content from the FOP's for AASHTO T 255/ T 265: 15.9%

Moisture content is greater than 1 percent different so the gauge moisture cannot be used.

Calculate the dry density as follows:

$$\begin{aligned} \rho_d &= \left(\frac{1963 \text{ kg/m}^3 \text{ or } 122.5 \text{ lb/ft}^3}{15.9 + 100} \right) \times 100 \quad \text{or} \quad \rho_d = \frac{1963 \text{ kg/m}^3 \text{ or } 122.5 \text{ lb/ft}^3}{\frac{15.9}{100} + 1} \\ &= 1694 \text{ kg/m}^3 \text{ or } 105.7 \text{ lb/ft}^3 \end{aligned}$$

Given:

ρ_w = 1963 kg/m³ or 122.5 lb/ft³

w = 15.9%

Calculate percent compaction as follows:

$$\% \text{ Compaction} = \frac{105.7 \text{ lb/ft}^3}{111.3 \text{ lb/ft}^3} \times 100 = 95\%$$

Given:

Agency density standard = 111.3 lb/ft³

Report

- On forms approved by the agency
- Sample ID
- Location of test, elevation of surface, and thickness of layer tested
- Visual description of material tested
- Make, model and serial number of the nuclear moisture-density gauge
- Wet density to the nearest 0.1 lb/ft³
- Moisture content as a percent, by mass, of dry soil mass to the nearest 0.1 percent
- Dry density to the nearest 0.1 lb/ft³
- Density standard to the nearest 0.1 lb/ft³
- Percent compaction the nearest 1 percent
- Name and signature of operator

ATM 215 One-Point Method for Determining Maximum Dry Density and Optimum Moisture

Following are guidelines for the use of WAQTC FOP for AASHTO T 272 by the State of Alaska DOT&PF.

This page left intentionally blank.

ONE-POINT METHOD FOR DETERMINING MAXIMUM DRY DENSITY AND OPTIMUM MOISTURE

FOP FOR AASHTO T 272

Scope

This procedure provides for a rapid determination of the maximum dry density and optimum moisture content of a soil sample, using a one-point determination in accordance with AASHTO T 272-18. This procedure is related to the FOPs for AASHTO T 99/T 180 and R 75.

One-point determinations are made by compacting the soil in a mold of a given size with a specified rammer dropped from a specified height and then compared to an individual moisture/density curve (FOP for AASHTO T 99 or T 180) or a family of curves (FOP for AASHTO R 75). Four alternate methods – A, B, C, and D – are used and correspond to the methods described in the FOP for AASHTO T 99/T 180. The method used in AASHTO T 272 must match the method used for the reference curve or to establish the family of curves. For example, when moisture-density relationships as determined by T 99 - Method C are used to form the family of curves or an individual moisture density curve, then T 99 - Method C must be used to for the one-point determination.

Apparatus

See the FOP for AASHTO T 99/T 180.

Sample

Sample size determined according to the FOP for AASHTO T 310. In cases where the existing individual curve or family cannot be used a completely new curve will need to be developed and the sample size will be determined by the FOP for AASHTO T 99/T 180.

1. If the sample is damp, dry it until it becomes friable under a trowel. Drying may be in air or by use of a drying apparatus maintained at a temperature not exceeding 60°C (140°F).
2. Thoroughly break up aggregations in a manner that avoids reducing the natural size of individual particles.
3. Pass the material through the appropriate sieve.

Procedure

Use the method matching the individual curve or Family of Curves. Refer to Table 1 of the FOP for AASHTO T 99 / T 180 for corresponding mold size, number of layers, number of blows, sieve size, and rammer specification for the various test methods.

1. Determine the mass of the clean, dry mold. Include the base plate but exclude the extension collar. Record the mass to the nearest 1 g (0.005 lb).
2. Thoroughly mix the sample with sufficient water to adjust moisture content to 80 to 100 percent of the anticipated optimum moisture.
3. Form a specimen by compacting the prepared soil in the mold (with collar attached) in approximately equal layers. For each layer:
 - a. Spread the loose material uniformly in the mold.

Note 1: It is recommended to cover the remaining material with a non-absorbent sheet or damp cloth to minimize loss of moisture.

- b. Lightly tamp the loose material with the manual rammer or other similar device, this establishes a firm surface.

- c. Compact each layer with uniformly distributed blows from the rammer.
 - d. Trim down material that has not been compacted and remains adjacent to the walls of the mold and extends above the compacted surface.
4. Remove the extension collar. Avoid shearing off the sample below the top of the mold. The material compacted in the mold should not be over 6 mm (¼ in.) above the top of the mold once the collar has been removed.
 5. Trim the compacted soil even with the top of the mold with the beveled side of the straightedge.
 6. Clean soil from exterior of the mold and base plate.
 7. Determine the mass of the mold and wet soil to the nearest 1 g (0.005 lb).
 8. Determine the wet mass of the sample by subtracting the mass in Step 1 from the mass in Step 7.
 9. Calculate the wet density (ρ_w) as indicated below under “Calculations.”
 10. Extrude the material from the mold. For soils and soil-aggregate mixtures, slice vertically through the center and remove one of the cut faces for a representative moisture content sample. For granular materials, a vertical face will not exist. Take a representative sample ensuring that all layers are represented. This sample must meet the sample size requirements of the test method used to determine moisture content.

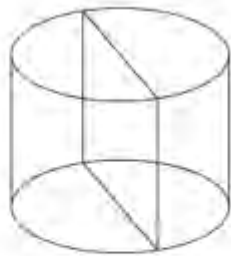

Extruded material

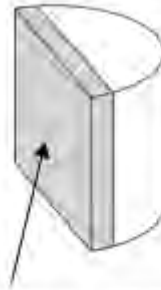

**Representative moisture
content sample**

11. Determine the moisture content (w) of the sample in accordance with the FOP for AASHTO T 255 / T 265.

Calculations

1. Calculate the wet density, in kg/m^3 (lb/ft^3), by dividing the wet mass by the measured volume of the mold (T 19).

Example – Methods A or C mold:

Wet mass = 2.0055 kg (4.42 lb)

Measured volume of the mold = 0.0009469 m^3 (0.0334 ft^3)

$$\rho_w = \frac{2.0055 \text{ kg}}{0.0009469 \text{ m}^3} = 2118 \text{ kg/m}^3$$

$$\rho_w = \frac{4.42 \text{ lb}}{0.0334 \text{ ft}^3} = 132.2 \text{ lb/ft}^3$$

Where:

ρ_w = Wet density, kg/m³ (lb/ft³)

2. Calculate the dry density as follows.

$$\rho_d = \left(\frac{\rho_w}{w + 100} \right) \times 100 \quad \text{or} \quad \rho_d = \frac{\rho_w}{\left(\frac{w}{100} \right) + 1}$$

Where:

ρ_d = Dry density, kg/m³ (lb/ft³)

w = Moisture content, as a percentage

Example:

ρ_w = 2118 kg/m³ (132.2 lb/ft³)

W = 13.5%

$$\rho_d = \left(\frac{2118 \text{ kg/m}^3}{13.5 + 100} \right) \times 100 = 1866 \text{ kg/m}^3 \quad \rho_d = \left(\frac{132.2 \text{ lb/ft}^3}{\frac{13.5}{100} + 1} \right) \times 100 = 116.5 \text{ lb/ft}^3$$

or

$$\rho_d = \left(\frac{2118 \text{ kg/m}^3}{\frac{13.5}{100} + 1} \right) = 1866 \text{ kg/m}^3 \quad \rho_d = \left(\frac{132.2 \text{ lb/ft}^3}{\frac{13.5}{100} + 1} \right) = 116.5 \text{ lb/ft}^3$$

Maximum Dry Density and Optimum Moisture Content Determination Using an Individual Moisture / Density Curve

1. The moisture content must be within 80 to 100 percent of optimum moisture of the reference curve. Compact another specimen, using the same material, at an adjusted moisture content if the one-point does not fall in the 80 to 100 percent of optimum moisture range.
2. Plot the one-point, dry density on the vertical axis and moisture content on the horizontal axis, on the reference curve graph.
3. If the one-point falls on the reference curve or within ± 2.0 lbs/ft³, use the maximum dry density and optimum moisture content determined by the curve.
4. Use the FOP for AASHTO T 99/T 180 Annex A to determine corrected maximum dry density and optimum moisture content if oversize particles have been removed.
5. Perform a full moisture-density relationship if the one-point does not fall on or within ± 2.0 lbs/ft³ of the reference curve at 80 to 100 percent optimum moisture.

Example

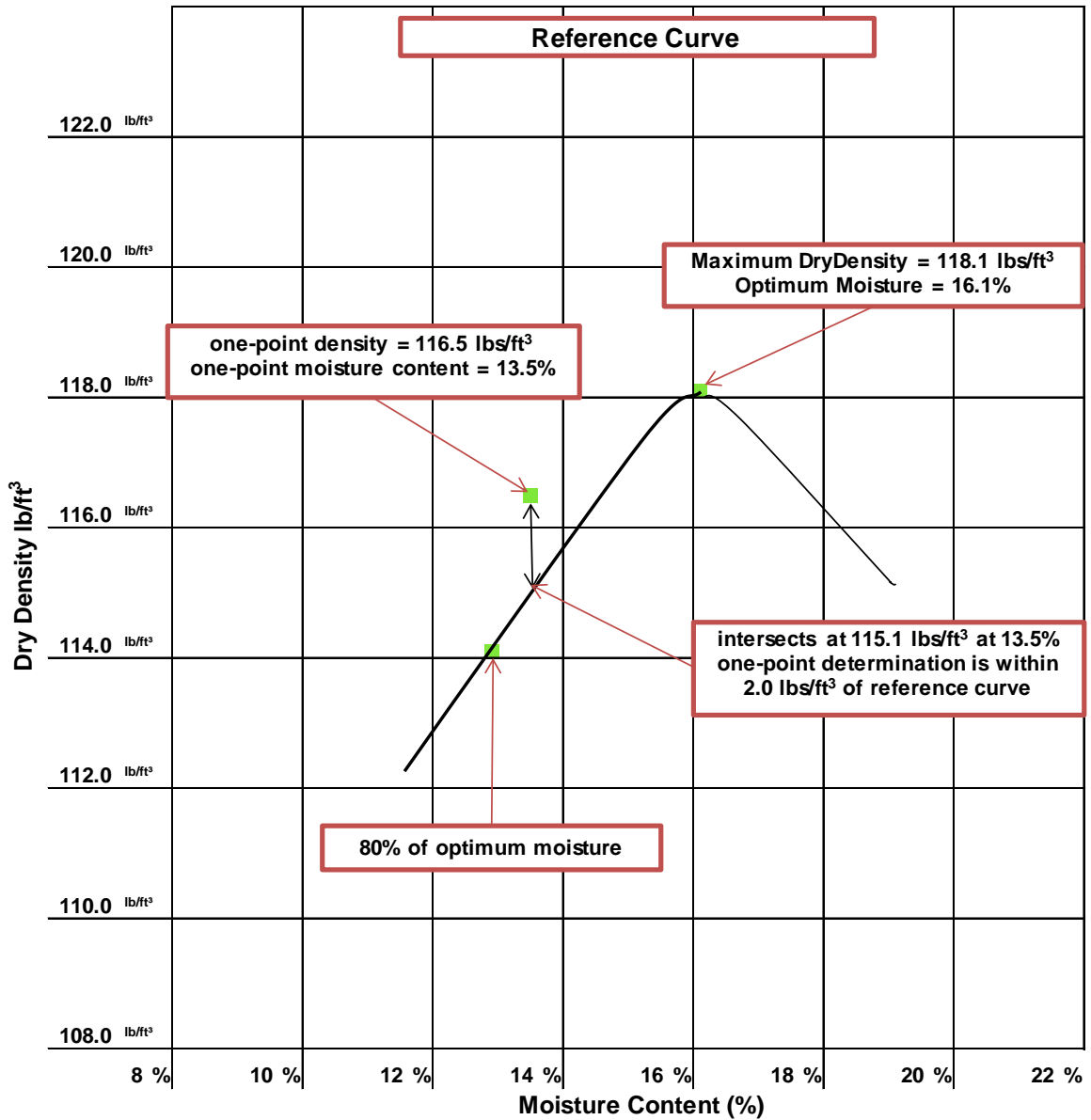

The results of a one-point determination were 116.5 lb/ft³ at 13.5 percent moisture. The point was plotted on the reference curve graph. The one-point determination is within 2.0 lb/ft³ of the point on the curve that corresponds with the moisture content.

Maximum Dry Density and Optimum Moisture Content Determination Using a Family of Curves

1. Plot the one-point, dry density on the vertical axis and moisture content on the horizontal axis, on the reference family of curves graph.
2. If the moisture-density one-point falls on one of the curves in the family of curves, use the maximum dry density and optimum moisture content defined by that curve.
3. If the moisture-density one-point falls within the family of curves but not on an existing curve, draw a new curve through the plotted single point, parallel and in character with the nearest existing curve in the family of curves. Use the maximum dry density and optimum moisture content as defined by the new curve.
 - a. The one-point must fall either between or on the highest or lowest curves in the family. If it does not, then a full curve must be developed.
 - b. If the one-point plotted within or on the family of curves does not fall in the 80 to 100 percent of optimum moisture content, compact another specimen, using the same material, at an adjusted moisture content that will place the one point within this range.
4. Use the FOP for AASHTO T 99/T 180 Annex A to determine corrected maximum dry density and optimum moisture content if oversize particles have been removed.
5. If the new curve through a one-point is not well defined or is in any way questionable, perform a full moisture-density relationship to correctly define the new curve and verify the applicability of the family of curves.

Note 2: New curves drawn through plotted single point determinations shall not become a permanent part of the family of curves until verified by a full moisture-density procedure following the FOP for AASHTO T 99/T 180.

Example

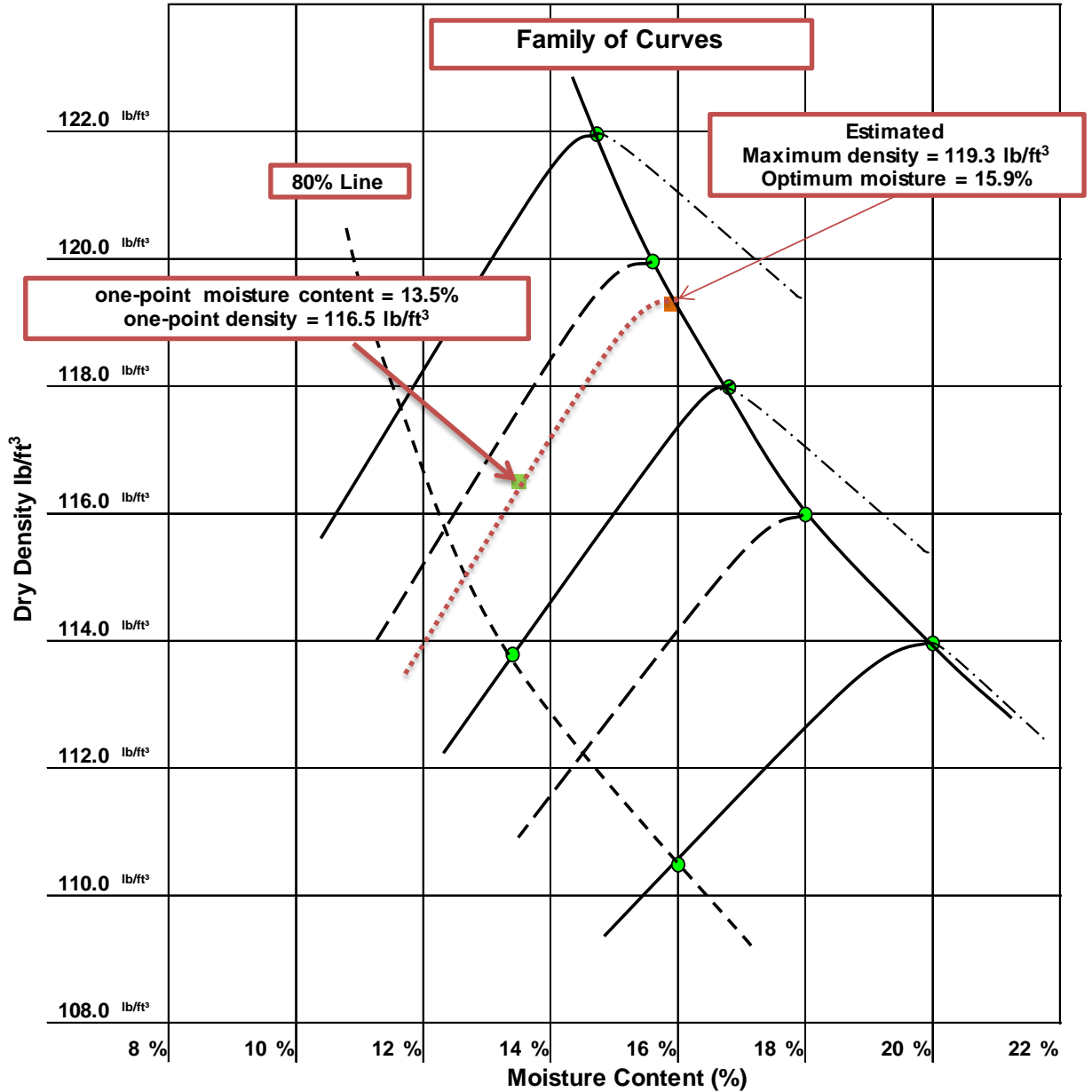

The results of a one-point determination were 116.5 lb/ft³ at 13.5 percent moisture. The point was plotted on the reference curve graph. The point was plotted on the appropriate family between two previously developed curves near and intermediate curve.

The “dotted” curve through the moisture-density one-point was sketched between the existing curves. A maximum dry density of 119.3 lb/ft³ and a corresponding optimum moisture content of 15.9 percent were estimated.

Report

- On forms approved by the agency
- Sample ID
- Maximum dry density to the nearest 1 kg/m³ (0.1 lb/ft³)
- Corrected maximum dry density (if applicable)
- Optimum moisture content to the nearest 0.1 percent
- Corrected optimum moisture content (if applicable)
- Reference curve or Family of Curves used

ATM 216 Developing a Family of Curves

Following are guidelines for the use of WAQTC FOP for AASHTO R 75 by the State of Alaska DOT&PF.

This page left intentionally blank.

DEVELOPING A FAMILY OF CURVES FOP FOR AASHTO R 75

Scope

This procedure provides a method to develop a family of curves in accordance with AASHTO R 75-16 using multiple moisture density relationships developed using the same method, A, B, C, or D, from the FOP for AASHTO T 99/T 180.

All curves used in a family must be developed using a single Method: A, B, C, or D of a procedure for AASHTO T 99 or T 180. See the FOP for AASHTO T 99/T 180.

Terminology

family of curves — a group of soil moisture-density relationships (curves) determined using AASHTO T 99 or T 180, which reveal certain similarities and trends characteristic of the soil type and source.

spine — smooth line extending through the point of maximum density/optimum moisture content of a family of moisture-density curves.

Procedure

1. Sort the curves by Method (A, B, C, or D of the FOP for T 99/T 180). At least three curves are required to develop a family.
2. Select the highest and lowest maximum dry densities from those selected to assist in determining the desired scale of the subsequent graph.
3. Plot the maximum density and optimum moisture points of the selected curves on the graph.
4. Draw a smooth, “best fit,” curved line through the points creating the spine of the family of curves.
5. Remove maximum density and optimum moisture points that were not used to establish the spine.
6. Add the moisture/density curves associated with the points that were used to establish the spine. It is not necessary to include the portion of the curves over optimum moisture.

Note 1—Intermediate template curves using slopes similar to those of the original moisture-density curves may be included when maximum density points are more than 2.0 lb/ft³ apart. Template curves are indicated by a dashed line.

7. Plot the 80 percent of optimum moisture range when desired:
 - a. Using the optimum moisture of an existing curve, calculate 80 percent of optimum moisture and plot this value on the curve. Repeat for each curve in the family.
 - b. Draw a smooth, “best fit,” curved line connecting the 80 percent of optimum moisture points plotted on the curves that parallel the spine.

Calculations

Calculate 80 percent of optimum moisture of each curve:

Example:

Optimum moisture of the highest density curve = 14.6%

$$80\% \text{ point} = \frac{80}{100} \times 14.6\% = 11.7\%$$

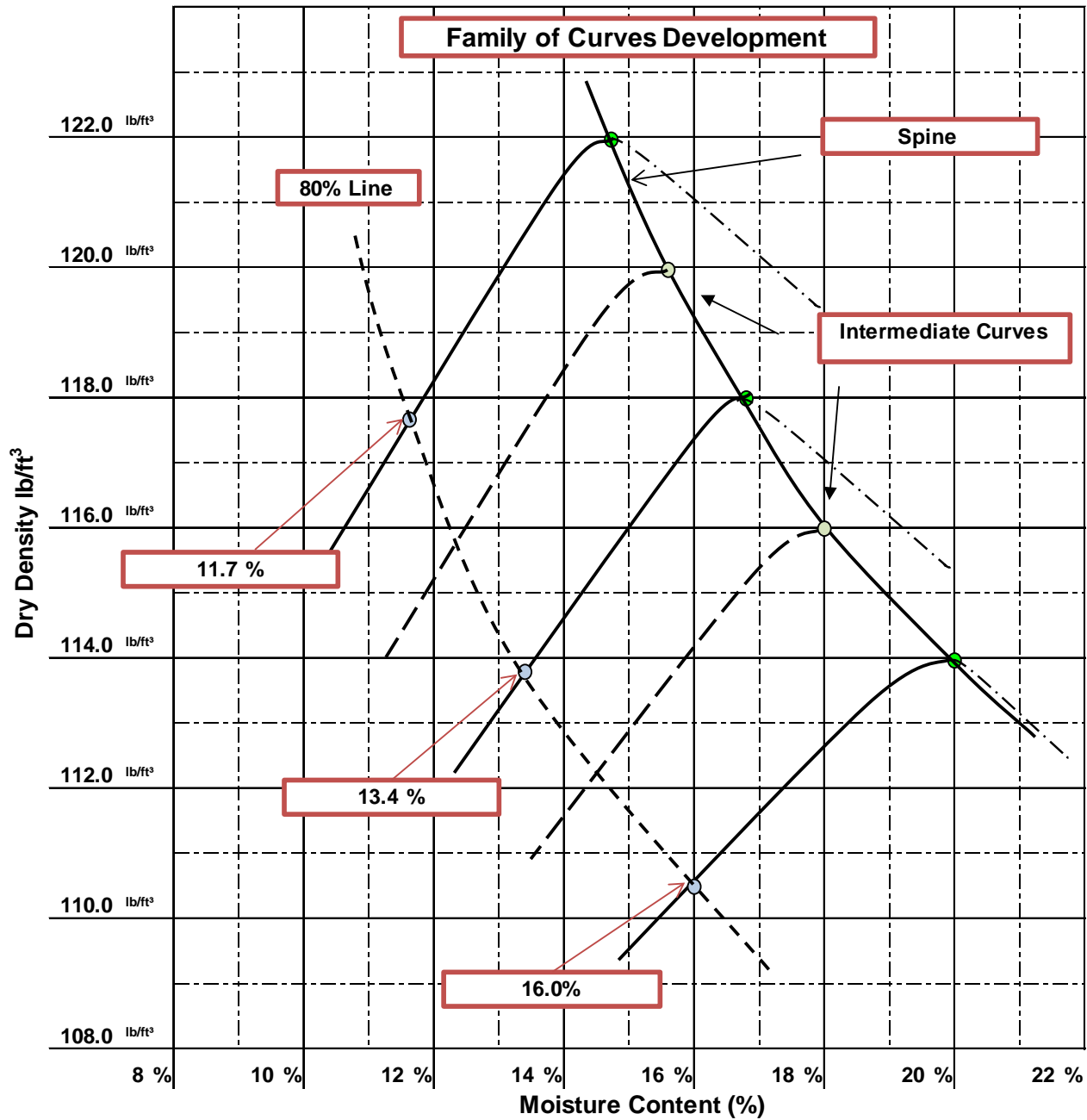

ATM 301 Sampling Aggregate Products

Following are guidelines for the use of WAQTC FOP for AASHTO R 90 by the State of Alaska DOT&PF.

1. Sample sizes in Table 2 may be used when sampling for WAQTC FOP for AASHTO T 27/T 11.
(See Procedure General Note 1).

Table 2
Sample Sizes

Nominal Maximum Size*, Standard		Minimum Mass,	
Alternate mm	in	g	lb
2.36	No. 8	10,000	25
4.75	No. 4	10,000	25
9.5	3/8	10,000	25
12.5	1/2	15,000	35
19.0	3/4	25,000	55
25.0	1	45,000	100
37.5	1-1/2	65,000	145
50	2	85,000	190
75	3	125,000	275

*Nominal Maximum Size: One sieve larger than the first sieve to retain more than 10 percent of the material using an agency specified set of sieves based on cumulative percent retained. Where large gaps in specification sieves exist, intermediate sieve(s) may be inserted to determine nominal maximum size.

Note 1: Sample size is based upon the test(s) required. As a general rule, the field sample size should be such that, when split twice will provide a testing sample of proper size. For example, the sample size may be four times that shown in Table 1 of the FOP for AASHTO T 27/T 11, if that mass is more appropriate.

2. Samples with a nominal maximum size greater than 3-inch will be sampled using the 3-inch line in Table 2.
3. Field samples containing +3 in. material may be reduced in the field. If allowed, the +3 in. material may be removed. Record the mass of +3 in. material, Note the presence of cobble material.
4. Under section "Report," change "Location" to "Location, source and sampling method."

This page intentionally left blank.

SAMPLING AGGREGATE PRODUCTS FOP FOR AASHTO R 90

Scope

This procedure covers sampling of coarse, fine, or a combination of coarse and fine aggregates (CA and FA) in accordance with AASHTO R 90-18. Sampling from conveyor belts, transport units, roadways, and stockpiles is covered.

Apparatus

- Shovels or scoops, or both
- Brooms, brushes, and scraping tools
- Sampling tubes of acceptable dimensions
- Mechanical sampling systems: normally a permanently attached device that allows a sample container to pass perpendicularly through the entire stream of material or diverts the entire stream of material into the container by manual, hydraulic, or pneumatic operation
- Belt template
- Sampling containers

Procedure – General

Sampling is as important as testing. The technician shall use every precaution to obtain samples that are representative of the material. Determine the time or location for sampling in a random manner.

1. Wherever samples are taken, obtain multiple increments of approximately equal size.
2. Mix the increments thoroughly to form a field sample that meets or exceeds the minimum mass recommended in Table 1.

TABLE 1
Recommended Sample Sizes

Nominal Maximum Size*		Minimum Mass	
mm	(in.)	g	(lb)
90	(3 1/2)	175,000	(385)
75	(3)	150,000	(330)
63	(2 1/2)	125,000	(275)
50	(2)	100,000	(220)
37.5	(1 1/2)	75,000	(165)
25.0	(1)	50,000	(110)
19.0	(3/4)	25,000	(55)
12.5	(1/2)	15,000	(35)
9.5	(3/8)	10,000	(25)
4.75	(No. 4)	10,000	(25)
2.36	(No. 8)	10,000	(25)

* One sieve larger than the first sieve to retain more than 10 percent of the material using an agency specified set of sieves based on cumulative percent retained. Where large gaps in specification sieves exist, intermediate sieve(s) may be inserted to determine nominal maximum size. Maximum size is one size larger than nominal maximum size.

Note 1: Sample size is based upon the test(s) required. As a general rule, the field sample size should be such that, when split twice will provide a testing sample of proper size. For example, the sample size may be four times that shown in Table 1 of the FOP for AASHTO T 27/T 11, if that mass is more appropriate.

(See 301 Guidance Page, guideline no. 1)

Procedure – Specific Situations

Conveyor Belts

Avoid sampling at the beginning or end of the aggregate run due to the potential for segregation. Be careful when sampling in the rain. Make sure to capture fines that may stick to the belt or that the rain tends to wash away.

Method A (From the Belt)

1. Stop the belt.
2. Set the sampling template in place on the belt, avoiding intrusion by adjacent material.
3. Remove the material from inside the template, including all fines.
4. Obtain at least three approximately equal increments.
5. Combine the increments and **mix thoroughly** to form a single sample.

Method B (From the Belt Discharge)

1. Pass a sampling device through the full stream of the material as it runs off the end of the conveyor belt. The sampling device may be manually, semi-automatic or automatically powered.
2. The sampling device shall pass through the stream at least twice, once in each direction, without overflowing while maintaining a constant speed during the sampling process.
3. When emptying the sampling device into the container, include all fines.
4. Combine the increments and **mix thoroughly** to form a single sample.

Transport Units

1. Visually divide the unit into four quadrants.
2. Identify one sampling location in each quadrant.
3. Dig down and remove approximately 0.3 m (1 ft.) of material to avoid surface segregation. Obtain each increment from below this level.
4. Combine the increments and mix thoroughly to form a single sample.

Roadways

Method A (Berm or Windrow)

1. Obtain sample before spreading.
2. Take the increments from at least three random locations along the fully formed windrow or berm. Do not take the increments from the beginning or the end of the windrow or berm.
3. Obtain full cross-section samples of approximately equal size at each location. Take care to exclude the underlying material.
4. Combine the increments and **mix thoroughly** to form a single sample.

Note 2: Obtaining samples from berms or windrows may yield extra-large samples and may not be the preferred sampling location.

Method B (In-Place)

1. Obtain sample after spreading and before compaction.
2. Take the increments from at least three random locations.
3. Obtain full-depth increments of approximately equal size from each location. Take care to exclude the underlying material.
4. Combine the increments and **mix thoroughly** to form a single sample.

Stockpiles

Method A – Loader Sampling

1. Direct the loader operator to enter the stockpile with the bucket at least 150 mm (6 in.) above ground level without contaminating the stockpile.
2. Discard the first bucketful.
3. Have the loader re-enter the stockpile and obtain a full loader bucket of the material, tilt the bucket back and up.
4. Form a small sampling pile at the base of the stockpile by gently rolling the material out of the bucket with the bucket just high enough to permit free flow of the material. (Repeat as necessary.)
5. Create a flat surface by having the loader back drag the small pile.
6. Visually divide the flat surface into four quadrants.
7. Collect an increment from each quadrant by fully inserting the shovel into the flat pile as vertically as possible, take care to exclude the underlying material, roll back the shovel and lift the material slowly out of the pile to avoid material rolling off the shovel.
8. Combine the increments and mix thoroughly to form a single sample.

Method B – Stockpile Face Sampling

1. Create horizontal surfaces with vertical faces in the top, middle, and bottom third of the stockpile with a shovel or loader.
2. Prevent continued sloughing by shoving a flat board against the vertical face. Sloughed material will be discarded to create the horizontal surface.
3. Obtain sample from the horizontal surface as close to the intersection as possible of the horizontal and vertical faces.
4. Obtain at least one increment of equal size from each of the top, middle, and bottom thirds of the pile.
5. Combine the increments to and mix thoroughly form a single sample.

Method C – Alternate Tube Method (Fine Aggregate)

1. Remove the outer layer that may have become segregated.
2. Using a sampling tube, obtain one increment of equal size from a minimum of five random locations on the pile.
3. Combine the increments to and mix thoroughly form a single sample.

Identification and Shipping

- Identify samples according to agency standards.
- Include sample report (below).
- Ship samples in containers that will prevent loss, contamination, or damage of material.

Report

- On forms approved by the agency
- Date
- Time
- Sample ID
- Sampling method
- Location
- Quantity represented
- Material type
- Supplier

This page intentionally left blank.

ATM 303 Reducing Samples of Aggregates to Testing Size

Following are guidelines for the use of WAQTC FOP for AASHTO R 76 by the State of Alaska DOT&PF.

1. When determining the correct number of chutes, the chutes will be a minimum of 1.5 times larger than the largest particle, utilizing the maximum even number of chutes possible.
2. AASHTO R 76 Method B may also be used for Fine Aggregate.
3. The check for effective reduction applies to assurance sample splits, at a minimum.

This page intentionally left blank.

REDUCING SAMPLES OF AGGREGATE TO TESTING SIZE FOP FOR AASHTO R 76

Scope

This procedure covers the reduction of samples to the appropriate size for testing in accordance with AASHTO R 76-16 (2020). Techniques are used that minimize variations in characteristics between test samples and field samples. Method A (Mechanical Splitter) and Method B (Quartering) are covered.

This FOP applies to fine aggregate (FA), coarse aggregate (CA), and mixes of the two (FA / CA) and may also be used on soils.

Apparatus

Method A – Mechanical Splitter

Splitter chutes:

- Even number of equal width chutes
- Discharge alternately to each side
- Minimum of 8 chutes total for CA and FA / CA, 12 chutes total for FA
- Width:
 - Minimum 50 percent larger than largest particle
 - Maximum chute width of 19 mm (3/4 in.) for fine aggregate passing the 9.5 mm (3/8 in.) sieve

Feed control:

- Hopper or straightedge pan with a width equal to or slightly less than the overall width of the assembly of chutes
- Capable of feeding the splitter at a controlled rate

Splitter receptacles / pans:

- Capable of holding two halves of the sample following splitting

The splitter and accessory equipment shall be so designed that the sample will flow smoothly without restriction or loss of material.

Method B – Quartering

- Straightedge scoop, shovel, or trowel
- Broom or brush
- **Tarp: A square canvas** or plastic sheet, appropriate for the amount and size of the material being reduced

Method Selection

Samples of CA may be reduced by either Method A or Method B.

Samples of FA which are drier than the saturated surface dry (SSD) condition, as described in AASHTO T 84, shall be reduced by a mechanical splitter according to Method A. As a quick approximation, if the fine aggregate will retain its shape when molded with the hand, it is wetter than SSD.

Samples of FA / CA which are drier than SSD may be reduced by Method A or Method B.

Samples of FA and FA / CA that are at SSD or wetter than SSD shall be reduced by Method B, or the entire sample may be dried – using temperatures that do not exceed those specified for any of the tests contemplated – and then reduced to test sample size using Method A.

Table 1

	Drier than SSD	Wetter than SSD
Fine Aggregate (FA)	Method A (Mechanical)	Method B (Quartering)
Mixture of FA/CA	Either Method	Method B (Quartering)
Coarse Aggregate (CA)	Either Method	Either Method

Procedure

Method A – Mechanical Splitter

1. Place two clean empty receptacles under the splitter.
2. Empty the sample into the hopper or pan without loss of material.
3. Uniformly distribute the material in the hopper or pan from edge to edge so that approximately equal amounts flow through each chute.
4. Discharge the material at a uniform rate, allowing it to flow freely through the chutes.
5. Remove any material retained on the surface of the splitter and place into the appropriate receptacle.
6. Using one of the two receptacles containing material, repeat Steps 1 through 6 until the material in one of the two receptacles is the appropriate sample size for the required test.
7. Retain and properly identify the remaining unused sample for further testing if required.

Mechanical Splitter Check

- Determine the mass of each reduced portion. If the percent difference of the two masses is greater than 5 percent, corrective action must be taken.

Calculation

$$\frac{\textit{Smaller Mass}}{\textit{Larger Mass}} = \textit{Ratio} \quad (1 - \textit{ratio}) \times 100 = \% \textit{ Difference}$$

Splitter check: 5127 g total sample mass

Splitter pan #1: 2583 g

Splitter pan #2: 2544 g

$$\frac{2544 \text{ g}}{2583 \text{ g}} = 0.985 \quad (1 - 0.985) \times 100 = 1.5\%$$

Alternative to Mechanical Splitter Check

- In lieu of determining the mass of each reduced portion, use the method illustrated in Figure 1 or 2 during reduction.

Figure 1

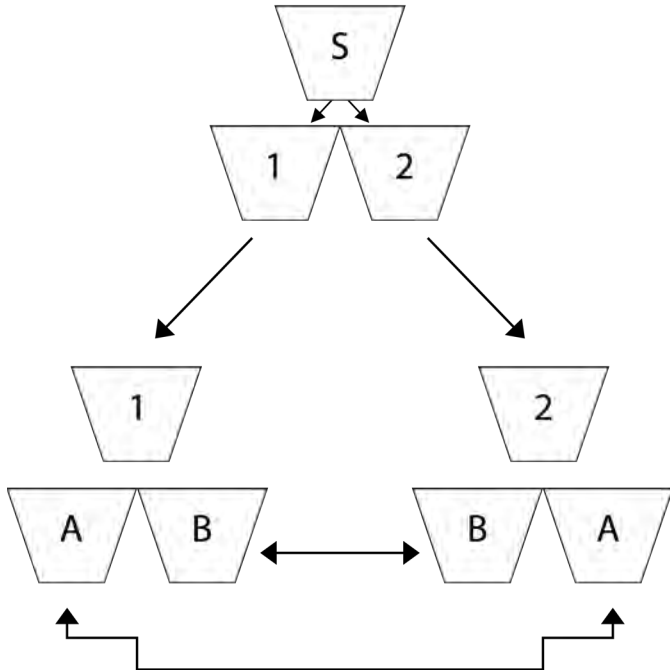

- Sample (S) is an amount greater than or equal to twice the mass needed for testing. Sample (S) is reduced in a mechanical splitter to yield parts (1) and (2).
- Part (1) is further reduced yielding (A) and (B) while part (2) is reduced to yield (B) and (A).
- Final testing sample is produced by combining alternate pans, i.e. A/A or B/B only.

Figure 2

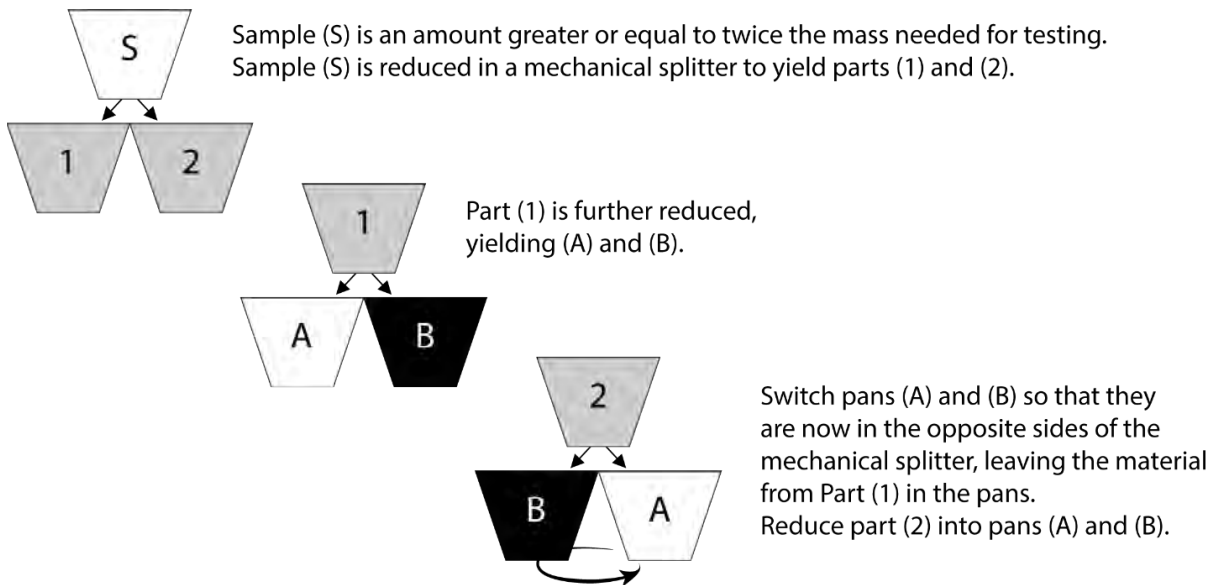

Method B – Quartering

Use either of the following two procedures or a combination of both.

Procedure 1: Quartering on a clean, hard, level surface:

1. Place the sample on a hard, clean, level surface where there will be neither loss of material nor the accidental addition of foreign material.
2. Mix the material thoroughly by turning the entire sample over a minimum of four times. With the last turning, shovel the entire sample into a conical pile by depositing each shovelful on top of the preceding one.
3. Flatten the conical pile to a uniform thickness and diameter by pressing down with a shovel. The diameter should be four to eight times the thickness.
4. Divide the flattened pile into four approximately equal quarters with a shovel or trowel.
5. Remove two diagonally opposite quarters, including all fine material, and brush the cleared spaces clean.
6. Successively mix and quarter the remaining material until the sample is reduced to the desired size.
7. The final test sample consists of two diagonally opposite quarters.

Procedure 2: Quartering on a tarp:

1. Place the sample on **the tarp**.
2. Mix the material thoroughly a minimum of four times by pulling each corner of the **tarp** horizontally over the sample toward the opposite corner. After the last turn, form a conical pile.
3. Flatten the conical pile to a uniform thickness and diameter by pressing down with a shovel. The diameter should be four to eight times the thickness.
4. Divide the flattened pile into four approximately equal quarters with a shovel **or trowel or** insert a stick or pipe beneath the **tarp and** under the center of the pile, then lift both ends of the stick, dividing the sample into two roughly equal parts. Remove the stick leaving a fold of the **tarp** between the divided portions. Insert the stick under the center of the pile at right angles to the first division and again lift both ends of the stick, dividing the sample into four roughly equal quarters.
5. Remove two diagonally opposite quarters, being careful to clean the fines from the **tarp**.
6. Successively mix and quarter the remaining material until the sample size is reduced to the desired size.
7. The final test sample consists of two diagonally opposite quarters.

This page intentionally left blank.

ATM 304 Sieve Analysis of Fine and Coarse Aggregates and Materials Finer than 75-µm (No. 200) Sieve in Mineral Aggregate by Washing

Following are guidelines for the use of WAQTC FOP for AASHTO T 27/T 11 by the State of Alaska DOT&PF.

1. Use Table 1 for all aggregate sizes:

Table 1
Sample sizes for Aggregate Gradation Test

Nominal Maximum Size*		Minimum Dry Mass	
Standard	Alternate	g	lb
mm	in		
75 plus	3 plus	125,000	275
75	3	30,000	66
A50	2	20,000	44
37.5	1-1/2	15,000	33
25.0	1	10,000	22
19.0	3/4	5000	11
12.5	1/2	2000	4
6.3	1/4	1000	2
9.5	3/8	1000	2
4.75	No. 4	500	1

*Nominal Maximum size: One sieve larger than the first sieve to retain more than 10 percent of the material using an agency specified set of sieves based on cumulative percent retained. Where large gaps between specification sieves exist, intermediate sieve(s) may be inserted to determine nominal maximum size.

2. DOT&PF does not allow the coarse aggregate to be run in a moist condition for sieve analysis.
3. Use Method C unless otherwise specified. Methods A or B may be used for concrete aggregate, **cover-coat aggregate** and materials with ¾" nominal maximum size or less.
4. All methods may use the alternative calculation of:

$$PP = \frac{(M - CMR)}{M} \times 100$$

Where:

CMR = Cumulative Mass Retained
M = Total Dry Sample mass before washing
PP = Percent Passing

5. For calculating Fineness Modulus, subtract reported percent passing from 100 to determine percent retained.

6. When testing Crushed Asphalt Base Course (CABC) or Recycled Asphalt Pavement (RAP), obtain samples in accordance with FOP for AASHTO T 2. Determine and record the total mass of the sample to the nearest 0.1 percent. Perform procedural Method C, steps 3-5 and step 12, except in step 4 the sample may be hand-shaken for the necessary time determined to provide complete separation; taking care not to overload sieves.
7. For material greater than 3 inch nominal maximum size, use minimum sample size of 275 pounds. Run entire sample for test. When required, collect and rebag minus 3 inch material and provide to independent assurance. Record the plus 3 inch material and transmit those numbers with the independent assurance sample.
8. For embankment material containing large oversize particles, which are not able to be tested according to conventional sieve analysis test methods (ATM 304), it is acceptable, subject to the approval of the RQE or RME, to provide pictorial evidence of the size and nature of the material being placed. The pictures shall either be embedded into the respective regional sieve analysis form(s) or attached to them. Utilize an object for scale reference that demonstrates size of embankment material containing large particles. The sieve analysis form must include: project name and number(s), field test number, pay item name and number, sample location (station, offset, depth), sample date, material source/Contractor, and quantity represented. Also include an acceptance statement with the inspector's name, date, and signature. The sieve analysis is to be signed and dated by the Project Engineer.
9. ANNEX B – use only the values from TABLE B1 to determine sieve overloading.

SIEVE ANALYSIS OF FINE AND COARSE AGGREGATES FOP FOR AASHTO T 27

MATERIALS FINER THAN 75 µM (NO. 200) SIEVE IN MINERAL AGGREGATE BY WASHING FOP FOR AASHTO T 11

Scope

A sieve analysis, or 'gradation,' measures distribution of aggregate particle sizes within a given sample.

Accurate determination of the amount of material smaller than 75 µm (No. 200) cannot be made using just AASHTO T 27. If quantifying this material is required, use AASHTO T 11 in conjunction with AASHTO T 27.

This FOP covers sieve analysis in accordance with AASHTO T 27-22 and materials finer than 75 µm (No. 200) in accordance with AASHTO T 11-22 performed in conjunction with AASHTO T 27. The procedure includes three methods: A, B, and C.

Apparatus

- Balance or scale: Capacity sufficient for the masses shown in Table 1, accurate to 0.1 percent of the sample mass or readable to 0.1 g, and meeting the requirements of AASHTO M 231
- Sieves: Meeting the requirements of ASTM E11
- Mechanical sieve shaker: Meeting the requirements of AASHTO T 27
- Suitable drying equipment (refer to FOP for AASHTO T 255)
- Containers and utensils: A pan or vessel of sufficient size to contain the sample covered with water and permit vigorous agitation without loss of material or water
- Optional
 - Mechanical washing device
 - Mallet: With a rubber or rawhide head having a mass of 0.57 ± 0.23 kg (1.25 ± 0.5 lb)

Sample Sieving

- In all procedures, the sample is shaken in nested sieves. Sieves are selected to furnish information required by specification. Intermediate sieves are added for additional information or to avoid overloading sieves, or both.
- The sieves are nested in order of increasing size from the bottom to the top, and the sample, or a portion of the sample, is placed on the top sieve.
- The loaded sieves are shaken in a mechanical shaker for approximately 10 minutes, refer to Annex A, *Time Evaluation*.
- Care must be taken so that sieves are not overloaded, refer to Annex B, *Overload Determination*. The sample may be sieved in increments and the mass retained for each sieve added together from each sample increment to avoid overloading sieves.

Sample Preparation

Obtain samples according to the FOP for AASHTO R 90 and reduce to sample size, shown in Table 1, according to the FOP for AASHTO R 76.

TABLE 1
Sample Sizes for Aggregate Gradation Test

Nominal Maximum Size*	Minimum Dry Mass
mm (in.)	g (lb)
125 (5)	300,000 (660)
100 (4)	150,000 (330)
90 (3 1/2)	100,000 (220)
75 (3)	60,000 (130)
63 (2 1/2)	35,000 (77)
50 (2)	20,000 (44)
37.5 (1 1/2)	15,000 (33)
25.0 (1)	10,000 (22)
19.0 (3/4)	5000 (11)
12.5 (1/2)	2000 (4)
9.5 (3/8)	1000 (2)
6.3 (1/4)	1000 (2)
4.75 (No. 4)	500 (1)

*Nominal maximum size: One sieve larger than the first sieve to retain more than 10 percent of the material using an agency specified set of sieves based on cumulative percent retained. Where large gaps between specification sieves exist, intermediate sieve(s) may be inserted to determine nominal maximum size.

Sample sizes in Table 1 are standard for aggregate sieve analysis, due to equipment restraints samples may need to be divided into several “subsamples.” For example, a gradation that requires 100 kg (220 lbs.) of material would not fit into a large tray shaker all at once.

Some agencies permit reduced sample sizes if it is proven that doing so is not detrimental to the test results. Some agencies require larger sample sizes. Check agency guidelines for required or permitted sample sizes.

Selection of Procedure

Agencies may specify which method to perform. If a method is not specified, perform Method A.

Overview

Method A

- Determine original dry mass of the sample
- Wash over a 75µm (No. 200) sieve
- Determine dry mass of washed sample
- Sieve washed sample

- Calculate and report percent retained and passing each sieve

Method B

- Determine original dry mass of the sample
- Wash over a 75 μm (No. 200) sieve
- Determine dry mass of washed sample
- Sieve sample through coarse sieves, 4.75 mm (No. 4) sieves and larger
- Determine mass of fine material, minus 4.75 mm (No. 4)
- Reduce fine material
- Determine mass of reduced portion
- Sieve reduced portion
- Calculate and report percent retained and passing each sieve

Method C

- Determine original dry mass of the sample
- Sieve sample through coarse sieves, 4.75 mm (No. 4) sieves and larger
- Determine mass of fine material, minus 4.75 mm (No. 4)
- Reduce fine material
- Determine mass of reduced portion
- Wash reduced portion over a 75 μm (No. 200) sieve
- Determine dry mass of washed reduced portion
- Sieve washed reduced portion
- Calculate and report percent retained and passing each sieve

Procedure Method A

1. Dry the sample to constant mass $110 \pm 5^\circ\text{C}$ ($230 \pm 9^\circ\text{F}$) according to the FOP for AASHTO T 255. Cool to room temperature.
2. Determine and record the original dry mass of the sample to the nearest 0.1 percent or 0.1 g. Designate this mass as *M*.

When the specification does not require the amount of material finer than 75 μm (No. 200) be determined by washing, skip to Step 11.

3. Nest a sieve, such as a 2.0 mm (No. 10), above the 75 μm (No. 200) sieve.
4. Place the sample in a container and cover with water.

Note 1: A detergent, dispersing agent, or other wetting solution may be added to the water to assure a thorough separation of the material finer than the 75 μm (No. 200) sieve from the coarser particles. There should be enough wetting agent to produce a small amount of suds when the sample is agitated. Excessive suds may overflow the sieves and carry material away with them.

5. Agitate vigorously to ensure complete separation of the material finer than 75 μm (No. 200) from coarser particles and bring the fine material into suspension above the coarser material. Avoid degradation of the sample when using a mechanical washing device.

Note 2: Washing longer than 10 minutes in a mechanical washer has been shown to cause significant amounts of degradation depending upon aggregate type.

6. Immediately pour the wash water containing the suspended material over the nested sieves; be careful not to pour out the coarser particles or over fill the 75 μm (No. 200) sieve.
7. Add water to cover material remaining in the container, agitate, and repeat Step 5. Continue until the wash water is reasonably clear.
8. Remove the upper sieve and return material retained to the washed sample.
9. Rinse the material retained on the 75 μm (No. 200) sieve until water passing through the sieve is reasonably clear and detergent or dispersing agent is removed, if used.
10. Return all material retained on the 75 μm (No. 200) sieve to the container by rinsing into the washed sample.

Note 3: Excess water may be carefully removed with a bulb syringe; the removed water must be discharged back over the 75 μm (No. 200) sieve to prevent loss of fines.

11. Dry the washed sample to constant mass at $110 \pm 5^\circ\text{C}$ ($230 \pm 9^\circ\text{F}$) according to the FOP for AASHTO T 255. Cool to room temperature.

12. Determine and record the dry mass of the sample.

13. Select sieves required by the specification and those necessary to avoid overloading as described in Annex B. With a pan on bottom, nest the sieves increasing in size starting with the 75 μm (No. 200).
14. Place the sample, or a portion of the sample, on the top sieve. Sieves may already be in the mechanical shaker, if not place sieves in mechanical shaker and shake for the minimum time determined to provide complete separation for the sieve shaker being used (approximately 10 minutes, the time determined by Annex A).

Note 4: Excessive shaking (more than 10 minutes) may result in degradation of the sample.

15. Determine and record the individual or cumulative mass retained for each sieve and in the pan. Ensure that all material trapped in full openings of the sieve are removed and included in the mass retained.

Note 5: For sieves 4.75 mm (No. 4) and larger, check material trapped in less than a full opening by sieving over a full opening. Use coarse wire brushes to clean the 600 μm (No. 30) and larger sieves, and soft bristle brushes for smaller sieves.

Note 6: In the case of coarse / fine aggregate mixtures, distribute the minus 4.75 mm (No. 4) among two or more sets of sieves to prevent overloading of individual sieves.

16. Perform the *Check Sum* calculation – Verify the *total mass after sieving* compared to the *dry mass before sieving* is not more than 0.3 percent. The *dry mass before sieving* is the dry mass after wash or the original dry mass (M) if performing the sieve analysis without washing. Do not use test results for acceptance if the *Check Sum* result is more than 0.3 percent.
17. Calculate the total percentages passing, and the individual or cumulative percentages retained to the nearest 0.1 percent by dividing the individual sieve masses or cumulative sieve masses by the original dry mass (M) of the sample.

18. Report total percent passing to 1 percent except report the 75 µm (No. 200) sieve to 0.1 percent.

Method A Calculations

Check Sum

$$\text{Check Sum} = \frac{\text{dry mass before sieving} - \text{total mass after sieving}}{\text{dry mass before sieving}} \times 100$$

Percent Retained

$$\text{IPR} = \frac{\text{IMR}}{M} \times 100 \quad \text{or} \quad \text{CPR} = \frac{\text{CMR}}{M} \times 100$$

Where:

- IPR = Individual Percent Retained
- CPR = Cumulative Percent Retained
- M = Original dry mass of the sample
- IMR = Individual Mass Retained
- CMR = Cumulative Mass Retained

Percent Passing (PP)

$$\text{PP} = \text{PPP} - \text{IPR} \quad \text{or} \quad \text{PP} = 100 - \text{CPR}$$

Where:

- PP = Percent Passing
- PPP = Previous Percent Passing

Method A Example Individual Mass Retained

Original dry mass of the sample (<i>M</i>):	5168.7 g
Dry mass of the sample after washing:	4911.3 g
Total mass after sieving equals	
Sum of Individual Masses Retained (IMR), including minus 75 µm (No. 200) in the pan:	4905.9 g
Amount of 75µm (No. 200) minus washed out (5168.7 g – 4911.3 g):	257.4 g

Check Sum

$$\text{Check Sum} = \frac{4911.3 \text{ g} - 4905.9 \text{ g}}{4911.3 \text{ g}} \times 100 = 0.1\%$$

The result is **not more than** 0.3 percent therefore the results can be used for acceptance purposes.

Individual Percent Retained (IPR) for 9.5 mm (3/8 in.) sieve:

$$\text{IPR} = \frac{619.2 \text{ g}}{5168.7 \text{ g}} \times 100 = 12.0\%$$

Percent Passing (PP) 9.5 mm (3/8 in.) sieve:

$$\text{PP} = 86.0\% - 12.0\% = 74.0\%$$

Reported Percent Passing = 74%

**Method A Individual
Gradation on All Sieves**

Sieve Size mm (in.)	Individual Mass Retained g (IMR)	Determine IPR by dividing IMR by <i>M</i> and multiplying by 100	Individual Percent Retained (IPR)	Determine PP by subtracting IPR from previous PP	Percent Passing (PP)	Reported Percent Passing*
19.0 (3/4)	0		0		100.0	100
12.5 (1/2)	724.7	$\frac{724.7}{5168.7} \times 100 =$	14.0	$100.0 - 14.0 =$	86.0	86
9.5 (3/8)	619.2	$\frac{619.2}{5168.7} \times 100 =$	12.0	$86.0 - 12.0 =$	74.0	74
4.75 (No. 4)	1189.8	$\frac{1189.8}{5168.7} \times 100 =$	23.0	$74.0 - 23.0 =$	51.0	51
2.36 (No. 8)	877.6	$\frac{877.6}{5168.7} \times 100 =$	17.0	$51.0 - 17.0 =$	34.0	34
1.18 (No. 16)	574.8	$\frac{574.8}{5168.7} \times 100 =$	11.1	$34.0 - 11.1 =$	22.9	23
0.600 (No. 30)	329.8	$\frac{329.8}{5168.7} \times 100 =$	6.4	$22.9 - 6.4 =$	16.5	17
0.300 (No. 50)	228.5	$\frac{228.5}{5168.7} \times 100 =$	4.4	$16.5 - 4.4 =$	12.1	12
0.150 (No. 100)	205.7	$\frac{205.7}{5168.7} \times 100 =$	4.0	$12.1 - 4.0 =$	8.1	8
0.075 (No. 200)	135.4	$\frac{135.7}{5168.7} \times 100 =$	2.6	$8.1 - 2.6 =$	5.5	5.5
minus 0.075 (No. 200) in the pan	20.4					
Total mass after sieving = sum of sieves + mass in the pan = 4905.9 g						
Original dry mass of the sample (<i>M</i>): 5168.7g						

* Report total percent passing to 1 percent except report the 75 μm (No. 200) sieve to 0.1 percent.

Method A Example Cumulative Mass Retained

Original dry mass of the sample (<i>M</i>):	5168.7 g
Dry mass of the sample after washing:	4911.3 g
Total mass after sieving equals Final Cumulative Mass Retained (FCMR) (includes minus 75 μm (No. 200) from the pan):	4905.9 g
Amount of 75μm (No. 200) minus washed out (5168.7 g – 4911.3 g):	257.4 g

Check Sum

$$\text{Check Sum} = \frac{4911.3 \text{ g} - 4905.9 \text{ g}}{4911.3 \text{ g}} \times 100 = 0.1\%$$

The result is **not more than** 0.3 percent therefore the results can be used for acceptance purposes.

Cumulative Percent Retained (CPR) for 9.5 mm (3/8 in.) sieve:

$$\text{CPR} = \frac{1343.9 \text{ g}}{5168.7 \text{ g}} \times 100 = 26.0\%$$

Percent Passing (PP) 9.5 mm (3/8 in.) sieve:

$$\text{PP} = 100.0\% - 26.0\% = 74.0\%$$

Reported Percent Passing = 74%

**Method A Cumulative
Gradation on All Sieves**

Sieve Size mm (in.)	Cumulative Mass Retained g (CMR)	Determine CPR by dividing CMR by M and multiplying by 100	Cumulative Percent Retained (CPR)	Determine PP by subtracting CPR from 100.0	Percent Passing (PP)	Reported Percent Passing*
19.0 (3/4)	0		0.0		100.0	100
12.5 (1/2)	724.7	$\frac{724.7}{5168.7} \times 100 =$	14.0	$100.0 - 14.0 =$	86.0	86
9.5 (3/8)	1343.9	$\frac{1343.9}{5168.7} \times 100 =$	26.0	$100.0 - 26.0 =$	74.0	74
4.75 (No. 4)	2533.7	$\frac{2533.7}{5168.7} \times 100 =$	49.0	$100.0 - 49.0 =$	51.0	51
2.36 (No. 8)	3411.3	$\frac{3411.3}{5168.7} \times 100 =$	66.0	$100.0 - 66.0 =$	34.0	34
1.18 (No. 16)	3986.1	$\frac{3986.1}{5168.7} \times 100 =$	77.1	$100.0 - 77.1 =$	22.9	23
0.600 (No. 30)	4315.9	$\frac{4315.9}{5168.7} \times 100 =$	83.5	$100.0 - 83.5 =$	16.5	17
0.300 (No. 50)	4544.4	$\frac{4544.4}{5168.7} \times 100 =$	87.9	$100.0 - 87.9 =$	12.1	12
0.150 (No. 100)	4750.1	$\frac{4750.1}{5168.7} \times 100 =$	91.9	$100.0 - 91.9 =$	8.1	8
0.075 (No. 200)	4885.5	$\frac{4885.5}{5168.7} \times 100 =$	94.5	$100.0 - 94.5 =$	5.5	5.5
FCMR	4905.9					
Total mass after sieving: 4905.9 g						
Original dry mass of the sample (M): 5168.7 g						

* Report total percent passing to 1 percent except report the 75 µm (No. 200) sieve to 0.1 percent.

Procedure Method B

1. Dry the sample to constant mass at $110 \pm 5^{\circ}\text{C}$ ($230 \pm 9^{\circ}\text{F}$) according to the FOP for AASHTO T 255. Cool to room temperature.
2. Determine and record the original dry mass of the sample to the nearest 0.1 percent or 0.1 g. Designate this mass as M .
3. When the specification does not require the amount of material finer than $75\ \mu\text{m}$ (No. 200) be determined by washing, skip to Step 12..
4. Nest a protective sieve, such as a 2.0 mm (No. 10), above the $75\ \mu\text{m}$ (No. 200) sieve.
5. Place the sample in a container and cover with water.

Note 1: A detergent, dispersing agent, or other wetting solution may be added to the water to assure a thorough separation of the material finer than the $75\ \mu\text{m}$ (No. 200) sieve from the coarser particles. There should be enough wetting agent to produce a small amount of suds when the sample is agitated. Excessive suds may overflow the sieves and carry material away with them.

6. Agitate vigorously to ensure complete separation of the material finer than $75\ \mu\text{m}$ (No. 200) from coarser particles and bring the fine material into suspension above the coarser material. Avoid degradation of the sample when using a mechanical washing device.

Note 2: Washing longer than 10 minutes in a mechanical washer has been shown to cause significant amounts of degradation depending upon aggregate type.

7. Immediately pour the wash water containing the suspended material over the nested sieves; be careful not to pour out the coarser particles or over fill the $75\ \mu\text{m}$ (No. 200) sieve.
8. Add water to cover material remaining in the container, agitate, and repeat Step 5. Continue until the wash water is reasonably clear.
9. Remove the upper sieve and return material retained to the washed sample.
10. Rinse the material retained on the $75\ \mu\text{m}$ (No. 200) sieve until water passing through the sieve is reasonably clear and detergent or dispersing agent is removed, if used.
11. Return all material retained on the $75\ \mu\text{m}$ (No. 200) sieve to the container by rinsing into the washed sample.

Note 3: Excess water may be carefully removed with a bulb syringe; the removed water must be discharged back over the $75\ \mu\text{m}$ (No. 200) sieve to prevent loss of fines.

12. Dry the washed sample to constant mass at $110 \pm 5^{\circ}\text{C}$ ($230 \pm 9^{\circ}\text{F}$) according to the FOP for AASHTO T 255. Cool to room temperature.

13. Determine and record the dry mass after wash.

14. Select sieves required by the specification and those necessary to avoid overloading as described in Annex B. With a pan on bottom, nest the sieves increasing in size starting with the 4.75 mm (No. 4).
15. Place the sample, or a portion of the sample, on the top sieve. Sieves may already be in the mechanical shaker, if not place the sieves in the mechanical shaker and shake for the minimum time determined to provide complete separation for the sieve shaker being used (approximately 10 minutes, the time determined by Annex A).

Note 4: Excessive shaking (more than 10 minutes) may result in degradation of the sample.

16. Determine and record the individual or cumulative mass retained for each sieve. Ensure that all particles trapped in full openings of the sieve are removed and included in the mass retained.

Note 5: For sieves 4.75 mm (No. 4) and larger, check material trapped in less than a full opening by sieving over a full opening. Use coarse wire brushes to clean the 600 μm (No. 30) and larger sieves, and soft hair bristle for smaller sieves.

17. Determine and record the mass of the minus 4.75 mm (No. 4) material in the pan. Designate this mass as M_1 .
18. Perform the *Coarse Check Sum* calculation – Verify the *total mass after coarse sieving* compared to the *dry mass before sieving* to not more than 0.3 percent. The *dry mass before sieving* is the dry mass after wash or the original dry mass (M) if performing the sieve analysis without washing. Do not use test results for acceptance if the *Check Sum* result is more than 0.3 percent.
19. Reduce the minus 4.75 mm (No. 4) according to the FOP for AASHTO R 76 to produce a sample with a minimum mass of 500 g. Determine and record the mass of the minus 4.75 mm (No. 4) split, designate this mass as M_2 .
20. Select sieves required by the specification and those necessary to avoid overloading as described in Annex B. With a pan on bottom, nest the sieves increasing in size starting with the 75 μm (No. 200) up to, but not including, the 4.75 mm (No. 4) sieve.
21. Place the sample portion on the top sieve and place the sieves in the mechanical shaker. Shake for the minimum time determined to provide complete separation for the sieve shaker being used (approximately 10 minutes, the time determined by Annex A).
22. Determine and record the individual or cumulative mass retained for each sieve and in the pan. Ensure that all particles trapped in full openings of the sieve are removed and included in the mass retained. (See Note 5.)
23. Perform the *Fine Check Sum* calculation – Verify the *total mass after sieving* compared to the *dry mass before sieving* (M_2) is not more than 0.3 percent. Do not use test results for acceptance if the *Check Sum* result is more than 0.3 percent.
24. Calculate to the nearest 0.1 percent, the Individual Mass Retained (IMR) or Cumulative Mass Retained (CMR) of the size increment of the reduced sample and the original sample.
25. Calculate the total percent passing.
26. Report total percent passing to 1 percent except report the 75 μm (No. 200) sieve to 0.1 percent.

Method B Calculations

Check Sum

$$\text{Coarse Check Sum} = \frac{\text{dry mass before sieving} - \text{total mass after coarse sieving}}{\text{dry mass before sieving}} \times 100$$

$$\text{Fine Check Sum} = \frac{M_2 - \text{total mass after fine sieving}}{M_2} \times 100$$

Percent Retained for 4.75 mm (No. 4) and larger

$$\text{IPR} = \frac{\text{IMR}}{M} \times 100 \quad \text{or} \quad \text{CPR} = \frac{\text{CMR}}{M} \times 100$$

Where:

- IPR = Individual Percent Retained
- CPR = Cumulative Percent Retained
- M = Original dry mass of the sample
- IMR = Individual Mass Retained
- CMR = Cumulative Mass Retained

Percent Passing (PP) for 4.75 mm (No. 4) and larger

$$\text{PP} = \text{PPP} - \text{IPR} \quad \text{or} \quad \text{PP} = 100 - \text{CPR}$$

Where:

- PP = Percent Passing
- PPP = Previous Percent Passing

Minus 4.75mm (No. 4) adjustment factor (R)

The mass of material retained for each sieve is multiplied by the adjustment factor, the total mass of the minus 4.75 mm (No. 4) from the pan, M_1 , divided by the mass of the reduced split of minus 4.75 mm (No. 4), M_2 . For consistency, this adjustment factor is carried to three decimal places.

$$R = \frac{M_1}{M_2}$$

Where:

- R = minus 4.75 mm (No. 4) adjustment factor
- M_1 = total mass of minus 4.75 mm (No. 4) before reducing
- M_2 = mass of the reduced split of minus 4.75 mm (No. 4)

Total Individual Mass Retained (TIMR):

$$\text{TIMR} = R \times B$$

Where:

- TIMR = Total Individual Mass Retained
- R = minus 4.75 mm (No. 4) adjustment factor
- B = individual mass of the size increment in the reduced portion sieved

Total Cumulative Mass Retained (TCMR)

$$TCMR = (R \times B) + D$$

Where:

TCMR = Total Cumulative Mass Retained

R = minus 4.75 mm (No. 4) adjustment factor

B = cumulative mass of the size increment in the reduced portion sieved

D = cumulative mass of plus 4.75mm (No. 4) portion of sample

Method B Example Individual Mass Retained

Dry mass of total sample, before washing:	3214.0 g
Dry mass of sample after washing:	3085.1 g
Total mass after sieving	
Sum of Individual Masses Retained (IMR) plus the minus 4.75 mm (No. 4) from the pan:	3085.0 g
Amount of 75 µm (No. 200) minus washed out (3214.0 g – 3085.1 g):	128.9 g

Coarse Check Sum

$$Coarse\ Check\ Sum = \frac{3085.1\ g - 3085.0\ g}{3085.1\ g} \times 100 = 0.0\%$$

The result is **not more than** 0.3 percent therefore the results can be used for acceptance purposes.

Individual Percent Retained (IPR) for 9.5 mm (3/8 in.) sieve

$$IPR = \frac{481.4\ g}{3214.0\ g} \times 100 = 15.0\%$$

Percent Passing (PP) for 9.5 mm (3/8 in.) sieve:

$$PP = 95.0\% - 15.0\% = 80.0\%$$

Reported Percent Passing = 80%

**Method B Individual
Gradation on Coarse Sieves**

Sieve Size mm (in.)	Individual Mass Retained g (IMR)	Determine IPR by dividing IMR by M and multiplying by 100	Individual Percent Retained (IPR)	Determine PP by subtracting IPR from previous PP	Percent Passing (PP)
16.0 (5/8)	0		0		100
12.5 (1/2)	161.1	$\frac{161.1}{3214.0} \times 100 =$	5.0	$100.0 - 5.0 =$	95.0
9.50 (3/8)	481.4	$\frac{481.4}{3214.0} \times 100 =$	15.0	$95.0 - 15.0 =$	80.0
4.75 (No. 4)	475.8	$\frac{475.8}{3214.0} \times 100 =$	14.8	$80.0 - 14.8 =$	65.2
Minus 4.75 (No. 4) in the pan	1966.7 (M_1)				
Total mass after sieving: sum of sieves + mass in the pan = 3085.0 g					
Original dry mass of the sample (M): 3214.0 g					

Fine Sample

The minus 4.75 mm (No. 4) from the pan, M_1 (1966.7 g), was reduced according to the FOP for AASHTO R 76, to at least 500 g. In this case, the reduced mass was determined to be **512.8 g**. This is M_2 .

The reduced mass was sieved.

Total mass after sieving equals

Sum of Individual Masses Retained (IMR) including
minus 75 μ m (No. 200) in the pan 511.8 g

Fine Check Sum

$$\text{Fine Check Sum} = \frac{512.8 \text{ g} - 511.8 \text{ g}}{512.8 \text{ g}} \times 100 = 0.2\%$$

The result is not more than an 0.3 percent therefore the results can be used for acceptance purposes.

Adjustment Factor (R) for Total Individual Mass Retained (TIMR) on minus 4.75 (No. 4) sieves

The mass of material retained for each sieve is multiplied by the adjustment factor (R) carried to three decimal places.

$$R = \frac{M_1}{M_2} = \frac{1,966.7 \text{ g}}{512.8 \text{ g}} = 3.835$$

Where:

- R = minus 4.75 mm (No. 4) adjustment factor
- M₁ = total mass of minus 4.75 mm (No. 4) from the pan
- M₂ = mass of the reduced split of minus 4.75 mm (No. 4)

Each “individual mass retained” on the fine sieves must be multiplied by *R* to obtain the **Total Individual Mass Retained (TIMR)**.

Total Individual Mass Retained (TIMR) for 2.00 mm (No. 10) sieve

$$TIMR = 3.835 \times 207.1 \text{ g} = 794.2 \text{ g}$$

Individual Percent Retained (IPR) for 2.00 mm (No. 10) sieve:

$$IPR = \frac{794.2 \text{ g}}{3214.0 \text{ g}} \times 100 = 24.7\%$$

Percent Passing (PP) 2 mm (No. 10) sieve:

$$PP = 65.2\% - 24.7\% = 40.5\%$$

Reported Percent Passing = 41%

Method B Individual Gradation on Fine Sieves

Sieve Size mm (in.)	Individual Mass Retained g (IMR)	Determine TIMR by multiplying IMR by $R \left(\frac{M_1}{M_2} \right)$	Total Individual Mass Retained (TIMR)
2.00 (No. 10)	207.1	$207.1 \times 3.835 =$	794.2
0.425 (No. 40)	187.9	$187.9 \times 3.835 =$	720.6
0.210 (No. 80)	59.9	$59.9 \times 3.835 =$	229.7
0.075 (No. 200)	49.1	$49.1 \times 3.835 =$	188.3
minus 0.075 (No. 200) in the pan	7.8		
Total mass after sieving: sum of fine sieves + the mass in the pan = 511.8 g			

**Method B Individual
Final Gradation on All Sieves**

Sieve Size mm (in.)	Total Individual Mass Retained g (TIMR)	Determine IPR by dividing TIMR by M and multiplying by 100	Individual Percent Retained (IPR)	Determine PP by subtracting IPR from previous PP	Percent Passing (PP)	Reported Percent Passing*
16.0 (5/8)	0		0		100	100
12.5 (1/2)	161.1	$\frac{161.1}{3214.0} \times 100 =$	5.0	$100.0 - 5.0 =$	95.0	95
9.50 (3/8)	481.4	$\frac{481.4}{3214.0} \times 100 =$	15.0	$95.0 - 15.0 =$	80.0	80
4.75 (No. 4)	475.8	$\frac{475.8}{3214.0} \times 100 =$	14.8	$80.0 - 14.8 =$	65.2	65
2.00 (No. 10)	794.2	$\frac{794.2}{3214.0} \times 100 =$	24.7	$65.2 - 24.7 =$	40.5	41
0.425 (No. 40)	720.6	$\frac{720.6}{3214.0} \times 100 =$	22.4	$40.5 - 22.4 =$	18.1	18
0.210 (No. 80)	229.7	$\frac{229.7}{3214.0} \times 100 =$	7.1	$18.1 - 7.1 =$	11.0	11
0.075 (No. 200)	188.3	$\frac{188.3}{3214.0} \times 100 =$	5.9	$11.0 - 5.9 =$	5.1	5.1
minus 0.075 (No. 200) in the pan	29.9					
Original dry mass of the sample (M): 3214.0 g						

* Report total percent passing to 1 percent except report the 75 μm (No. 200) sieve to 0.1 percent.

Method B Example Cumulative Mass Retained

Original dry mass of the sample (M):	3214.0 g
Dry mass of sample after washing:	3085.1 g
Total mass after sieving equals	
Cumulative Mass Retained (CMR) on the 4.75 (No. 4) plus the minus 4.75 mm (No. 4) in the pan:	3085.0 g
Amount of 75 μm (No. 200) minus washed out (3214.0 g – 3085.1 g):	128.9 g

Coarse Check Sum

$$\text{Coarse Check Sum} = \frac{3085.1 \text{ g} - 3085.0 \text{ g}}{3085.1 \text{ g}} \times 100 = 0.0\%$$

The result is **not more than** 0.3 percent therefore the results can be used for acceptance purposes.

Cumulative Percent Retained (CPR) for 9.5 mm (3/8 in.) sieve

$$\text{CPR} = \frac{642.5 \text{ g}}{3214.0 \text{ g}} \times 100 = 20.0\%$$

Percent Passing (PP) for 9.5 mm (3/8 in.) sieve

$$\text{PP} = 100.0\% - 20.0\% = 80.0\%$$

Reported Percent Passing = 80%

Method B Cumulative Gradation on Coarse Sieves

Sieve Size mm (in.)	Cumulative Mass Retained g (CMR)	Determine CPR by dividing CMR by M and multiplying by 100	Cumulative Percent Retained (CPR)	Determine PP by subtracting CPR from 100.0	Percent Passing (PP)
16.0 (5/8)	0		0		100
12.5 (1/2)	161.1	$\frac{161.1}{3214.0} \times 100 =$	5.0	$100.0 - 5.0 =$	95.0
9.50 (3/8)	642.5	$\frac{642.5}{3214.0} \times 100 =$	20.0	$100.0 - 20.0 =$	80.0
4.75 (No. 4)	1118.3 (D)	$\frac{1118.3}{3214.0} \times 100 =$	34.8	$100.0 - 34.8 =$	65.2
Minus 4.75 (No. 4) in the pan	1966.7 (M ₁)				
CMR: 1118.3 + 1966.7 = 3085.0					
Original dry mass of the sample (M): 3214.0 g					

Fine Sample

The mass of minus 4.75 mm (No. 4) material in the pan, M_1 (1966.7 g), was reduced according to the FOP for AASHTO R 76, to at least 500 g. In this case, the reduced mass was determined to be **512.8 g**. This is M_2 .

The reduced mass was sieved.

Total mass after fine sieving equals

Final Cumulative Mass Retained (FCMR) (includes minus 75 μm (No. 200) from the pan):

511.8 g

Fine Check Sum

$$\text{Fine Check Sum} = \frac{512.8 \text{ g} - 511.8 \text{ g}}{512.8 \text{ g}} \times 100 = 0.2\%$$

The result is not more than 0.3 percent therefore the results can be used for acceptance purposes.

The cumulative mass of material retained for each sieve is multiplied by the adjustment factor (R) carried to three decimal places to obtain the *Adjusted Cumulative Mass Retained (ACMR)* and added to the cumulative mass retained on the 4.75 mm (No. 4) sieve, D , to obtain the *Total Cumulative Mass Retained (TCMR)*.

Adjustment factor (R) for Adjusted Cumulative Mass Retained (ACMR) in minus 4.75 (No. 4) sieves.

$$R = \frac{M_1}{M_2} = \frac{1,966.7 \text{ g}}{512.8 \text{ g}} = 3.835$$

Where:

R = minus 4.75 mm (No. 4) adjustment factor

M_1 = total mass of minus 4.75 mm (No. 4) from the pan

M_2 = mass of the reduced split of minus 4.75 mm (No. 4)

Adjusted Cumulative Mass Retained (ACMR) for the 2.00 mm (No. 10) sieve

$$\text{ACMR} = 3.835 \times 207.1 \text{ g} = 794.2 \text{ g}$$

Total Cumulative Mass Retained (TCMR) for the 2.00 mm (No. 10) sieve

$$\text{TCMR} = 794.2 \text{ g} + 1118.3 \text{ g} = 1912.5 \text{ g}$$

Cumulative Percent Retained (CPR) for 2.00 mm (No. 10) sieve:

$$\text{CPR} = \frac{1912.5 \text{ g}}{3214.0 \text{ g}} \times 100 = 59.5\%$$

Percent Passing (PP) 2.00 mm (No. 10) sieve:

$$\text{PP} = 100.0\% - 59.5\% = 40.5\%$$

Reported Percent Passing = 41%

**Method B Cumulative
Gradation on Fine Sieves**

Sieve Size mm (in.)	Cumulative Mass Retained, g (CMR)	Determine TCMR by multiplying CMR by $R \left(\frac{M_1}{M_2}\right)$ and adding D	Total Cumulative Mass Retained (TCMR)
2.00 (No. 10)	207.1	$207.1 \times 3.835 + 1118.3 =$	1912.5
0.425 (No. 40)	395.0	$395.0 \times 3.835 + 1118.3 =$	2633.1
0.210 (No. 80)	454.9	$454.9 \times 3.835 + 1118.3 =$	2862.8
0.075 (No. 200)	504.0	$504.0 \times 3.835 + 1118.3 =$	3051.1
FCMR	511.8		
Total: sum of masses on fine sieves + minus 75 μ m (No. 200) in the pan = 511.8			

**Method B Cumulative
Final Gradation on All Sieves**

Sieve Size mm (in.)	Total Cumulative Mass Retained g (TCMR)	Determine CPR by dividing CMR by M and multiplying by 100	Cumulative Percent Retained (CPR)	Determine PP by subtracting CPR from 100.0	Percent Passing (PP)	Reported Percent Passing*
16.0 (5/8)	0		0		100.0	100
12.5 (1/2)	161.1	$\frac{161.1}{3214.0} \times 100 =$	5.0	$100.0 - 5.0 =$	95.0	95
9.5 (3/8)	642.5	$\frac{642.5}{3214.0} \times 100 =$	20.0	$100.0 - 20.0 =$	80.0	80
4.75 (No. 4)	1118.3 (D)	$\frac{1118.3}{3214.0} \times 100 =$	34.8	$100.0 - 34.8 =$	65.2	65
2.00 (No. 10)	1912.5	$\frac{1912.5}{3214.0} \times 100 =$	59.5	$100.0 - 59.5 =$	40.5	41
0.425 (No. 40)	2633.1	$\frac{2633.1}{3214.0} \times 100 =$	81.9	$100.0 - 81.9 =$	18.1	18
0.210 (No. 80)	2862.8	$\frac{2862.8}{3214.0} \times 100 =$	89.1	$100.0 - 89.1 =$	10.9	11
0.075 (No. 200)	3051.1	$\frac{3051.1}{3214.0} \times 100 =$	94.9	$100.0 - 94.9 =$	5.1	5.1
FCMR	3081.1					
Original dry mass of the sample (M): 3214.0 g						

* Report total percent passing to 1 percent except report the 75 μ m (No. 200) sieve to 0.1 percent.

Procedure Method C

1. Dry the sample to constant mass at $110 \pm 5^{\circ}\text{C}$ ($230 \pm 9^{\circ}\text{F}$) according to the FOP for AASHTO T 255. Cool to room temperature.
2. Determine and record the original dry mass of the sample to the nearest 0.1 percent or 0.1 g. Designate this mass as M .
3. Break up any aggregations or lumps of clay, silt, or adhering fines to pass the 4.75 mm (No. 4) sieve.
4. Select sieves required by the specification and those necessary to avoid overloading as described in Annex B. With a pan on bottom, nest the sieves increasing in size starting with the 4.75 mm (No. 4) sieve.
5. Place the sample, or a portion of the sample, on the top sieve. Sieves may already be in the mechanical shaker, if not place the sieves in the mechanical shaker and shake for the minimum time determined to provide complete separation for the sieve shaker being used (approximately 10 minutes, the time determined by Annex A).

Note 1: Excessive shaking (more than 10 minutes) may result in degradation of the sample.

6. Determine and record the cumulative mass retained for each sieve. Ensure that all material trapped in full openings of the sieve are removed and included in the mass retained.

Note 2: For sieves 4.75 mm (No. 4) and larger, check material trapped in less than a full opening sieving over a full opening. Use coarse wire brushes to clean the 600 μm (No. 30) and larger sieves, and soft bristle brush for smaller sieves.

7. Determine and record the mass of the minus 4.75 mm (No. 4) material in the pan. Designate this mass as M_1 .
8. Perform the *Coarse Check Sum* calculation –Verify the total mass after coarse sieving compared to the original dry mass (M) is not more than 0.3 percent.
9. Reduce the minus 4.75 mm (No. 4) according to the FOP for AASHTO R 76, to produce a sample with a minimum mass of 500 g.
10. Determine and record the mass of the minus 4.75 mm (No. 4) split, designate this mass as M_3 .
11. Nest a protective sieve, such as a 2.0 mm (No. 10), above the 75 μm (No. 200) sieve.
12. Place the sample in a container and cover with water.

Note 3: A detergent, dispersing agent, or other wetting solution may be added to the water to assure a thorough separation of the material finer than the 75 μm (No. 200) sieve from the coarser particles. There should be enough wetting agent to produce a small amount of suds when the sample is agitated. Excessive suds may overflow the sieves and carry material away with them.

13. Agitate vigorously to ensure complete separation of the material finer than 75 μm (No. 200) from coarser particles and bring the fine material into suspension above the coarser material. Avoid degradation of the sample when using a mechanical washing device.

Note 4: Washing longer than 10 minutes in a mechanical washer has been shown to cause significant amounts of degradation depending upon aggregate type.

14. Immediately pour the wash water containing the suspended material over the nested sieves; be careful not to pour out the coarser particles or over fill the 75 μm (No. 200) sieve.
15. Add water to cover material remaining in the container, agitate, and repeat Step 12. Repeat until the wash water is reasonably clear.

16. Remove the upper sieve and return material retained to the washed sample.
17. Rinse the material retained on the 75 µm (No. 200) sieve until water passing through the sieve is reasonably clear and detergent or dispersing agent is removed, if used.
18. Return all material retained on the 75 µm (No. 200) sieve to the container by flushing into the washed sample.

Note 5: Excess water may be carefully removed with a bulb syringe; the removed water must be discharged back over the 75 µm (No. 200) sieve to prevent loss of fines.
19. Dry the washed sample portion to constant mass at 110 ± 5°C (230 ± 9°F) according to the FOP for AASHTO T 255. Cool to room temperature. Determine and record the dry mass, designate this mass as *dry mass before sieving*.
20. Select sieves required by the specification and those necessary to avoid overloading as described in Annex B. With a pan on bottom, nest the sieves increasing in size starting with the 75 µm (No. 200) sieve up to, but not including the 4.75 mm (No. 4) sieve.
21. Place the sample portion on the top sieve. Place the sieves in the mechanical shaker and shake for the minimum time determined to provide complete separation for the sieve shaker being used (approximately 10 minutes, the time determined by Annex A).

Note 6: Excessive shaking (more than 10 minutes) may result in degradation of the sample.
22. Determine and record the cumulative mass retained for each sieve. Ensure that all material trapped in full openings of the sieve are removed and included in the mass retained.

Note 7: For sieves 4.75 mm (No. 4) and larger, check material trapped in less than a full opening by sieving over a full opening. Use coarse wire brushes to clean the 600 µm (No. 30) and larger sieves, and soft bristle brushes for smaller sieves.
23. Perform the *Fine Check Sum* calculation – Verify the *total mass after fine sieving* compared to the *dry mass before sieving* is not more than 0.3 percent. Do not use test results for acceptance if the *Check Sum* is more than 0.3 percent.
24. Calculate the Cumulative Percent Retained (CPR) and Percent Passing (PP) for the 4.75 mm (No. 4) and larger.
25. Calculate the Cumulative Percent Retained (CPR_{#4}) and the Percent Passing (PP_{#4}) for minus 4.75 mm (No. 4) split and Percent Passing (PP) for the minus 4.75 mm (No. 4).
26. Report total percent passing to 1 percent except report the 75 µm (No. 200) sieve to 0.1 percent.

Method C Calculations

Check Sum

$$\text{Coarse check sum} = \frac{M - \text{total mass after coarse sieving}}{M} \times 100$$

$$\text{Fine check sum} = \frac{\text{dry mass before sieving} - \text{total mass after fine sieving}}{\text{dry mass before sieving}} \times 100$$

Where:

M = Original dry mass of the sample

Cumulative Percent Retained (CPR) for 4.75 mm (No. 4) sieve and larger

$$CPR = \frac{CMR}{M} \times 100$$

Where:

CPR = Cumulative Percent Retained of the size increment for the total sample

CMR = Cumulative Mass Retained of the size increment for the total sample

M = Total dry sample mass before washing

Percent Passing (PP) 4.75 mm (No. 4) sieve and larger

$$PP = 100 - CPR$$

Where:

PP = Percent Passing of the size increment for the total sample

CPR = Cumulative Percent Retained of the size increment for the total sample

Or calculate PP for sieves larger than 4.75 mm (No. 4) sieve without calculating CPR

$$\frac{M - CMR}{M} \times 100$$

Cumulative Percent Retained (CPR_{#4}) for minus 4.75 mm (No. 4) split

$$CPR_{\#4} = \frac{CMR_{\#4}}{M_3} \times 100$$

Where:

CPR_{#4} = Cumulative Percent Retained for the sieve sizes of M₃

CMR_{#4} = Cumulative Mass Retained for the sieve sizes of M₃

M₃ = Total mass of the minus 4.75 mm (No. 4) split before washing

Percent Passing (PP_{#4}) for minus 4.75 mm (No. 4) split

$$PP_{\#4} = 100 - CPR_{\#4}$$

Where:

PP_{#4} = Percent Passing for the sieve sizes of M₃

CPR_{#4} = Cumulative Percent Retained for the sieve sizes of M₃

Percent Passing (PP) for sieves smaller than 4.75 mm (No. 4) sieve

$$PP = \frac{(PP_{\#4} \times \#4 PP)}{100}$$

Where:

PP = Total Percent Passing

PP_{#4} = Percent Passing for the sieve sizes of M₃

#4 PP = Total Percent Passing the 4.75 mm (No. 4) sieve

Or calculate PP for sieves smaller than 4.75 mm (No. 4) sieve without calculating $CPR_{\#4}$ and $PP_{\#4}$

$$PP = \frac{\#4 PP}{M_3} \times (M_3 - CMR_{\#4})$$

Where:

- PP = Total Percent Passing
- #4 PP = Total Percent Passing the 4.75 mm (No. 4) sieve
- M_3 = Total mass of the minus 4.75 mm (No. 4) split before washing
- $CMR_{\#4}$ = Cumulative Mass Retained for the sieve sizes of M_3

Method C Example

Original dry mass of the sample (M): 3304.5 g

Total mass after sieving equals

Cumulative Mass Retained (CMR) on the 4.75 (No. 4) plus the minus 4.75 mm (No. 4) from the pan: 3085.0 g

Coarse Check Sum

$$\text{Coarse Check Sum} = \frac{3304.5 \text{ g} - 3304.5 \text{ g}}{3304.5 \text{ g}} \times 100 = 0.0\%$$

The result is **not more than** 0.3 percent therefore the results can be used for acceptance purposes.

Cumulative Percent Retained (CPR) for the 9.5 mm (3/8 in.) sieve:

$$CPR = \frac{604.1 \text{ g}}{3304.5 \text{ g}} \times 100 = 18.3\%$$

Percent Passing (PP) for the 9.5 mm (3/8 in.) sieve:

$$PP = 100.0\% - 18.3\% = 81.7\%$$

Reported Percent Passing = 82%

Example for Alternate Percent Passing (PP) formula for the 9.5 mm (3/8 in.) sieve:

$$PP = \frac{3304.5 - 604.1}{3304.5} \times 100 = 81.7\%$$

Reported Percent Passing = 82%

**Method C Cumulative
Gradation on Coarse Sieves**

Sieve Size mm (in.)	Cumulative Mass Retained, g (CMR)	Determine CPR by dividing CMR by M and multiplying by 100	Cumulative Percent Retained (CPR)	Determine PP by subtracting CPR from 100.0	Percent Passing (PP)	Reported Percent Passing*
16.0 (5/8)	0		0.0		100.0	100
12.5 (1/2)	125.9	$\frac{125.9}{3304.5} \times 100 =$	3.8	$100.0 - 3.8 =$	96.2	96
9.50 (3/8)	604.1	$\frac{604.1}{3304.5} \times 100 =$	18.3	$100.0 - 18.3 =$	81.7	82
4.75 (No. 4)	1295.6	$\frac{1295.6}{3304.5} \times 100 =$	39.2	$100.0 - 39.2 =$	60.8 (#4 PP)	61
Mass in pan	2008.9					
CMR: 1295.6 + 2008.9 = 3304.5						
Original dry mass of the sample (M): 3304.5						

Fine Sample

The pan (2008.9 g) was reduced according to the FOP for AASHTO R 76, to at least 500 g. In this case, the reduced mass was determined to be **527.6 g**. This is M_3 .

Dry mass of minus 4.75mm (No. 4) reduced portion before wash (M_3): 527.6 g

Dry mass of minus 4.75mm (No. 4) reduced portion after wash: 495.3 g

Total mass after fine sieving equals

Final Cumulative Mass Retained (FCMR)
(includes minus 75 μ m (No. 200) from the pan): 495.1 g

Fine Check Sum

$$\text{Fine Check Sum} = \frac{495.3 \text{ g} - 495.1 \text{ g}}{495.3 \text{ g}} \times 100 = 0.0\%$$

The result is **not more than** 0.3 percent therefore the results can be used for acceptance purposes.

Cumulative Percent Retained (CPR_{#4}) for minus 4.75 mm (No. 4) for the 2.0 mm (No. 10) sieve:

$$\text{CPR}_{\#4} = \frac{194.3 \text{ g}}{527.6 \text{ g}} \times 100 = 36.8\%$$

Percent Passing (PP_{#4}) for minus 4.75 mm (No. 4) for the 2.0 mm (No. 10) sieve:

$$PP_{\#4} = 100.0\% - 36.8\% = 63.2\%$$

**Method C Cumulative
Gradation on Fine Sieves**

Sieve Size mm (in.)	Cumulative Mass Retained g (CMR _{#4})	Determine CPR _{#4} by dividing CMR by M ₃ and multiplying by 100	Cumulative Percent Retained _{#4} (CPR _{#4})	Determine PP _{#4} by subtracting CPR _{#4} from 100.0	Percent Passing _{#4} (PP _{#4})
2.0 (No. 10)	194.3	$\frac{194.3}{527.6} \times 100 =$	36.8	$100.0 - 36.8 =$	63.2
0.425 (No. 40)	365.6	$\frac{365.6}{527.6} \times 100 =$	69.3	$100.0 - 69.3 =$	30.7
0.210 (No. 80)	430.8	$\frac{430.8}{527.6} \times 100 =$	81.7	$100.0 - 81.7 =$	18.3
0.075 (No. 200)	484.4	$\frac{484.4}{527.6} \times 100 =$	91.8	$100.0 - 91.8 =$	8.2
FCMR	495.1				
Dry mass of minus 4.75mm (No. 4) reduced portion before wash (M ₃): 527.6 g					
Dry mass after washing: 495.3 g					

Percent Passing (PP) for the 2.0 mm (No. 10) sieve for the entire sample:

#4 PP (Total Percent Passing the 4.75 mm (No. 4) sieve) = 60.8%

$$PP = \frac{63.2\% \times 60.8\%}{100} = 38.4\%$$

Reported Percent Passing = 38%

**Method C Cumulative
Final Gradation on All Sieves**

Sieve Size mm (in.)	Cumulative Mass Retained g (CMR)	Cumulative Percent Retained (CPR)	Percent Passing (PP -#4)	Determine PP by multiplying PP-#4 by #4 PP and dividing by 100	Percent Passing (PP)	Reported Percent Passing*
16.0 (5/8)	0	0.0			100.0	100
12.5 (1/2)	125.9	3.8			96.2	96
9.5 (3/8)	604.1	18.3			81.7	82
4.75 (No. 4)	1295.6	39.2			60.8 (#4 PP)	61
2.0 (No. 10)	194.3	36.8	63.2	$\frac{63.2 \times 60.8}{100} =$	38.4	38
0.425 (No. 40)	365.6	69.3	30.7	$\frac{30.7 \times 60.8}{100} =$	18.7	19
0.210 (No. 80)	430.8	81.7	18.3	$\frac{18.3 \times 60.8}{100} =$	11.1	11
0.075 (No. 200)	484.4	91.8	8.2	$\frac{8.2 \times 60.8}{100} =$	5.0	5.0
FCMR	495.1					

* Report total percent passing to 1 percent except report the 75 µm (No. 200) sieve to 0.1 percent.

Example for Alternate Percent Passing (PP) for the 4.75 mm (No. 4) sieve for the entire sample:

#4 PP (Total Percent Passing the 4.75 mm (No. 4) sieve) = 60.8%

$$PP = \frac{60.8\%}{527.6} \times (527.6 - 194.3) = 38.4\%$$

Reported Percent Passing = 38%

**Alternate Method C Cumulative
Gradation on Coarse Sieves**

Sieve Size mm (in.)	Cumulative Mass Retained, g (CMR)	Determine PP by subtracting CMR from M, and dividing the result by M then multiplying by 100	Percent Passing (PP)	Reported Percent Passing*
16.0 (5/8)	0.0		100.0	100
12.5 (1/2)	125.9	$\frac{3304.5 - 125.9}{3304.5} \times 100 =$	96.2	96
9.5 (3/8)	604.1	$\frac{3304.5 - 604.1}{3304.5} \times 100 =$	81.7	82
4.75 (No. 4)	1295.6	$\frac{3304.5 - 1295.6}{3304.5} \times 100 =$	60.8 (#4 PP)	61
Mass in Pan	2008.9			
Cumulative sieved mass: 1295.6 + 2008.9 = 3304.5				
Original dry mass of the sample (M): 3304.5				

**Alternate Method C Cumulative
Gradation on Fine Sieves**

Sieve Size mm (in.)	Cumulative Mass Retained g (CMR _{#4})	Determine PP _{#4} by subtracting CMR _{#4} from M ₃ , dividing result by M ₃ and multiplying by 100	Percent Passing _{#4} (PP _{#4})
2.0 (No. 10)	194.3	$\frac{527.6 - 194.3}{527.6} \times 100 =$	63.2
0.425 (No. 40)	365.6	$\frac{527.6 - 365.6}{527.6} \times 100 =$	30.7
0.210 (No. 80)	430.8	$\frac{527.6 - 430.8}{527.6} \times 100 =$	18.3
0.075 (No. 200)	484.4	$\frac{527.6 - 484.4}{527.6} \times 100 =$	8.2
FCMR	495.1		
Dry mass of minus 4.75mm (No. 4) reduced portion before wash (M ₃): 527.6 g			
Dry mass after washing: 495.3 g			

**Alternate Method C Cumulative
Final Gradation on All Sieves**

Sieve Size mm (in.)	Percent Passing _{#4} (PP _{#4})	Determine PP by multiplying PP _{#4} by #4 PP and dividing by 100	Determined Percent Passing (PP)	Reported Percent Passing*
16.0 (5/8)			100.0	100
12.5 (1/2)			96.2	96
9.5 (3/8)			81.7	82
4.75 (No. 4)			60.8 (#4 PP)	61
2.0 (No. 10)	63.2	$\frac{63.2 \times 60.8}{100} =$	38.4	38
0.425 (No. 40)	30.7	$\frac{30.7 \times 60.8}{100} =$	18.7	19
0.210 (No. 80)	18.3	$\frac{18.3 \times 60.8}{100} =$	11.1	11
0.075 (No. 200)	8.2	$\frac{8.2 \times 60.8}{100} =$	5.0	5.0

* Report total percent passing to 1 percent except report the 75 μm (No. 200) sieve to 0.1 percent.

FINENESS MODULUS

Fineness Modulus (FM) is used in determining the degree of uniformity of the aggregate gradation in PCC mix designs. It is an empirical number relating to the fineness of the aggregate. The higher the FM the coarser the aggregate. Values of 2.40 to 3.00 are common for fine aggregate in PCC.

The sum of the cumulative percentages retained on specified sieves in the following table divided by 100 gives the FM.

Sample Calculation

	Example A				Example B		
	Percent				Percent		
		Retained				Retained	
Sieve Size mm (in)	Passing		On Spec'd Sieves*		Passing		On Spec'd Sieves*
75*(3)	100	0	0		100	0	0
37.5*(11/2)	100	0	0		100	0	0
19*(3/4)	15	85	85		100	0	0
9.5*(3/8)	0	100	100		100	0	0
4.75*(No.4)	0	100	100		100	0	0
2.36*(No.8)	0	100	100		87	13	13
1.18*(No.16)	0	100	100		69	31	31
0.60*(No.30)	0	100	100		44	56	56
0.30*(No.50)	0	100	100		18	82	82
0.15*(100)	0	100	100		4	96	96
			$\Sigma = 785$				$\Sigma = 278$
			FM = 7.85				FM = 2.78

In decreasing size order, each * sieve is one-half the size of the preceding * sieve.

Report

- On forms approved by the agency
 - Sample ID
 - Percent passing for each sieve
 - Individual mass retained for each sieve
 - Individual percent retained for each sieve
- or
- Cumulative mass retained for each sieve
 - Cumulative percent retained for each sieve
 - FM to the nearest 0.01
 - Report percentages to the nearest 1 percent except for the percent passing the 75 μm (No. 200) sieve, which shall be reported to the nearest 0.1 percent.

ANNEX A

Time Evaluation

(Mandatory information)

The sieving time for each mechanical sieve shaker shall be checked at least annually to determine the time required for complete separation of the sample by the following method:

Shake the sample over nested sieves for approximately 10 minutes.

Provide a snug-fitting pan and cover for each sieve and hold in a slightly inclined position in one hand.

Hand shake each sieve by striking the side of the sieve sharply and with an upward motion against the heel of the other hand at the rate of about 150 times per minute, turning the sieve about one sixth of a revolution at intervals of about 25 strokes.

Note AI: A mallet may be used instead of the heel of the hand if comparable force is used.

If more than 0.5 percent by mass of the total sample before sieving passes any sieve after one minute of continuous hand shaking adjust shaker time and re-check.

In determining sieving time for sieve sizes larger than 4.75 mm (No. 4), limit the material on the sieve to a single layer of particles.

ANNEX B

Overload Determination

(Mandatory information)

Additional sieves may be necessary to keep from overloading sieves or to provide other information, such as fineness modulus. The sample may also be sieved in increments to prevent overloading.

For sieves with openings smaller than 4.75 mm (No. 4), the mass retained on any sieve shall not exceed 7 kg/m² (4 g/in²) of sieving surface.

For sieves with openings 4.75 mm (No. 4) and larger, the mass, in grams shall not exceed the product of 2.5 × (sieve opening in mm) × (effective sieving area). See Table B1.

TABLE B1
Maximum Allowable Mass of Material Retained on a Sieve, g
Nominal Sieve Size, mm (in.)
Exact size is smaller (see AASHTO T 27)

Sieve Size mm (in.)	203 dia (8)	305 dia (12)	305 by 305 (12 × 12)	350 by 350 (14 × 14)	372 by 580 (16 × 24)
Sieving Area m ²					
	0.0285	0.0670	0.0929	0.1225	0.2158
90 (3 1/2)	*	15,100	20,900	27,600	48,500
75 (3)	*	12,600	17,400	23,000	40,500
63 (2 1/2)	*	10,600	14,600	19,300	34,000
50 (2)	3600	8400	11,600	15,300	27,000
37.5 (1 1/2)	2700	6300	8700	11,500	20,200
25.0 (1)	1800	4200	5800	7700	13,500
19.0 (3/4)	1400	3200	4400	5800	10,200
16.0 (5/8)	1100	2700	3700	4900	8600
12.5 (1/2)	890	2100	2900	3800	6700
9.5 (3/8)	670	1600	2200	2900	5100
6.3 (1/4)	440	1100	1500	1900	3400
4.75 (No. 4)	330	800	1100	1500	2600
-4.75 (-No. 4)	200	470	650	860	1510

ATM 305 Determining the Percentage of Fracture in Coarse Aggregate

Following are guidelines for the use of WAQTC FOP for AASHTO T 335 by the State of Alaska DOT&PF.

- Fracture is determined by Method 1 unless otherwise specified.
- Unless otherwise specified the 4.75 mm (No.4) sieve shall be used to obtain the test sample.
- When determining the fracture on a post ignition sample from ATM 406 Determining the Asphalt Binder Content of Hot Mix Asphalt (HMA) by the Ignition Method, use the entire coarse (+#4 sieve) portion of the post-ignition aggregate, regardless if it less than the minimum required in Table 1.

This page intentionally left blank.

DETERMINING THE PERCENTAGE OF FRACTURE IN COARSE AGGREGATE FOP FOR AASHTO T 335

Scope

This procedure covers the determination of the percentage, by mass, of a coarse aggregate (CA) sample that consists of fractured particles meeting specified requirements in accordance with AASHTO T 335-09.

In this FOP, a sample of aggregate is screened on the sieve separating CA and fine aggregate (FA). This sieve will be identified in the agency's specifications but might be the 4.75 mm (No. 4) sieve. CA particles are visually evaluated to determine conformance to the specified **fractured criteria**. The percentage of conforming particles, by mass, is calculated for comparison to the specifications.

Apparatus

- Balance or scale: Capacity sufficient for the **principal** sample mass, accurate to 0.1 percent of the sample mass or readable to 0.1 g and meeting the requirements of AASHTO M 231.
- Sieves: Meeting requirements of the FOP for AASHTO T 27/T 11.
- Splitter: Meeting the requirements of FOP for AASHTO R 76.

Terminology

1. **Fractured criteria: Determined by the agency to define a fractured particle.**
2. Fractured face: An angular, rough, or broken surface of an aggregate particle created by crushing or by other means. A face is considered a "fractured face" whenever one-half or more of the projected area, when viewed normal to that face, is fractured with sharp and well-defined edges. This excludes small nicks.
3. Fractured particle: A particle of aggregate having at least the minimum number of fractured faces specified. (This is usually one or two.)

Sampling and Sample Preparation

1. Sample and reduce the aggregate in accordance with the FOPs for AASHTO R 90 and R 76.
2. When the specifications list only a total fracture percentage, the sample shall be prepared in accordance with Method 1. When the specifications require that the fracture be counted and reported on each sieve, the sample shall be prepared in accordance with Method 2.
3. Method 1 - Combined Fracture Determination
 - a. Dry the sample sufficiently to obtain a clean separation of FA and CA material in the sieving operation.
 - b. Sieve the sample in accordance with the FOP for AASHTO T 27/ T 11 over the 4.75 mm (No. 4) sieve, or the appropriate sieve listed in the agency's specifications for this material.

Note 1: Where necessary, wash the sample over the sieve designated for the determination of fractured particles to remove any remaining fine material, and dry to a constant mass in accordance with the FOP for AASHTO T 255.

- c. Reduce the sample using Method A – Mechanical Splitter, in accordance with the FOP for AASHTO R 76, to the appropriate test size. This test size should be slightly larger than shown in Table 1, to account for loss of fines through washing if necessary.

TABLE 1
Sample Size
Method 1 (Combined Sieve Fracture)

Nominal Maximum Size*		Minimum Cumulative Sample Mass Retained on 4.75 mm (No. 4) Sieve	
mm	(in.)	g	(lb)
37.5	(1 1/2)	2500	(6)
25.0	(1)	1500	(3.5)
19.0	(3/4)	1000	(2.5)
12.5	(1/2)	700	(1.5)
9.5	(3/8)	400	(0.9)
4.75	(No. 4)	200	(0.4)

* One sieve larger than the first sieve to retain more than 10 percent of the material using an agency specified set of sieves based on cumulative percent retained. Where large gaps in specification sieves exist, intermediate sieve(s) may be inserted to determine nominal maximum size.

4. Method 2 – Individual Sieve Fracture Determination

- a. Dry the sample sufficiently to obtain a clean separation of FA and CA material in the sieving operation. A washed sample from the gradation determination (the FOP for T 27/T 11) may be used.
- b. If not, sieve the sample in accordance with the FOP for AASHTO T 27 over the sieves listed in the specifications for this material.

Note 2: If overload (buffer) sieves are used the material from that sieve must be added to the next specification sieve.

- c. The size of test sample for each sieve shall meet the minimum size shown in Table 2. Utilize the total retained sieve mass or select a representative portion from each sieve mass by splitting or quartering in accordance with the FOP for AASHTO R 76.

Note 3: Where necessary, wash the sample over the sieves designated for the determination of fractured particles to remove any remaining fine material, and dry to a constant mass in accordance with the FOP for AASHTO T 255.

TABLE 2
Sample Size
Method 2 (Individual Sieve Fracture)

Sieve Size		Minimum Sample Mass	
mm	(in.)	g	(lb)
31.5	(1 1/4)	1500	(3.5)
25.0	(1)	1000	(2.2)
19.0	(3/4)	700	(1.5)
16.0	(5/8)	500	(1.0)
12.5	(1/2)	300	(0.7)
9.5	(3/8)	200	(0.5)
6.3	(1/4)	100	(0.2)
4.75	(No. 4)	100	(0.2)

Sieve Size		Minimum Sample Mass	
mm	(in.)	g	(lb)
2.36	(No. 8)	25	(0.1)
2.00	(No. 10)	25	(0.1)

Note 4: If fracture is determined on a sample obtained for gradation, use the mass retained on the individual sieves, even if it is less than the minimum listed in Table 2. If less than 5 percent of the total mass is retained on a single specification sieve, include that material on the next smaller specification sieve. If a smaller specification sieve does not exist, this material shall not be included in the fracture determination.

Procedure

1. After cooling, spread the dried sample on a clean, flat surface.
2. Examine each particle face and determine if the particle meets the **fractured criteria**.
3. Separate the sample into three categories:
 - Fractured particles meeting the criteria
 - Particles not meeting the criteria
 - Questionable or borderline particles
4. Determine the dry mass of particles in each category to the nearest 0.1 g.
5. Calculate the percent questionable **particles to the nearest 1 percent**.
6. Re-sort the questionable particles when more than 15 percent is present. Continue sorting until there is no more than 15 percent in the questionable category.
7. Calculate the percent fractured particles meeting criteria to nearest 0.1 percent. Report to 1 percent.

Calculation

Calculate the **percent** questionable particles to the nearest 1 percent using the following formula:

$$\%Q = \frac{Q}{F + Q + N} \times 100$$

Where:

- %Q = Percent of questionable particles
- F = Mass of fractured particles
- Q = Mass of questionable or borderline particles
- N = Mass of unfractured particles

Example:

$$\%Q = \frac{97.6 \text{ g}}{632.6 \text{ g} + 97.6 \text{ g} + 352.6 \text{ g}} \times 100 = 9\%$$

Given:

- F = 632.6 g
- Q = 97.6 g
- N = 352.6 g

Calculate the percent fractured particles to the nearest 0.1 percent using the following formula:

$$P = \frac{\frac{Q}{2} + F}{F + Q + N} \times 100$$

Where:

- P = Percent of fractured particles
- F = Mass of fractured particles
- Q = Mass of questionable particles
- N = Mass of unfractured particles

Example:

$$P = \frac{\frac{97.6 \text{ g}}{2} + 632.6 \text{ g}}{632.6 \text{ g} + 97.6 \text{ g} + 352.6 \text{ g}} \times 100 = 62.9\% \quad \text{Report 63\%}$$

Given:

- F = 632.6 g
- Q = 97.6 g
- N = 352.6 g

Report

- On forms approved by the agency
- Sample ID
- Fractured particles to the nearest 1 percent.

ATM 306 Determining the Percentage of Flat and Elongated Particles in Coarse Aggregate

1. Scope

This procedure covers the determination of the percentages of flat (thin) and elongated particles in coarse aggregates.

2. Apparatus

The apparatus used shall consist of any suitable equipment, by means of which aggregate particles may be tested for compliance, at the dimensional ratios desired, with the definitions given below. Types of acceptable apparatus are:

- ASTM Proportional Caliper Device meeting the requirements of ASTM D 4791. Illustrated in Fig.1
- Balance or scale: Capacity sufficient for the sample mass, readable to 0.1 g and accurate to 0.1 percent of test load, meeting the requirements of AASHTO M 231, Class G 2.

Note: This test requires a scale with a capacity of at least 1200 g and readable to 0.1 g, or better.

- Sieves, meeting the requirements of AASHTO M 92 (ASTM E11)

3. Definitions

1. Length — maximum dimension of the particle.
2. Thickness — maximum dimension perpendicular to the length and width.
3. Flat & Elongated Particle — a particle having a ratio of length to thickness greater than that specified.

4. Sampling and Sample Preparation

1. Sample and reduce the aggregate in accordance with the FOPs for AASHTO T 2 (ASTM D75) and R 76.
2. Flat and Elongated Determination
 - a. Dry the sample sufficiently to obtain a clean separation of FA and CA material in the sieving operation.
 - b. Sieve the sample in accordance with the FOP for AASHTO T 27/ T 11 over the 4.75 mm (No. 4) sieve.
 - c. Reduce the sample using Method A – Mechanical Splitter, in accordance with the FOP for AASHTO T 248, to the appropriate test size. This test size should be slightly larger than shown in Table 1, to account for loss of fines through washing if necessary.

**Table 1
Sample Size**

Size Fraction		Minimum Sample Mass
(mm)	(in)	g
-37.5 to +19.0	-1½ to +¾	1000
-19.0 to +9.5	-¾ to +⅜	500
-9.5 to +4.75	-⅜ to +No. 4	100

Note 1: If this test is performed using a sample obtained for gradation, use the mass retained for the size fraction, regardless of the sample mass required by Table 1. If less than 5 percent of the total mass is retained on a single specification sieve, include that material on the next smaller specification sieve.

5. Procedure

1. Unless specified, the caliper ratio shall be 1:5.
2. Determine and record the total dry mass of the size grouping to be tested to the nearest 0.1 g.
3. Flat and Elongated Particle Test — Recombine, if necessary, all of the particles from the above process.
4. Set the larger opening to the particle's length. The particle is flat and elongated if the particle's thickness can pass completely through the smaller opening.
5. Determine and record the mass of the flat and elongated particles to the nearest 0.1 g.

6. Calculation

1. Calculate the cumulative percent retained.

$$\text{CPR} = 100 - \text{CPP}$$

Where :

CPR = Cumulative percent retained on original sample gradation

CPP = Cumulative percent passing from original sample gradation.

2. Calculate the cumulative percent retained of each size group flat and elongated (F&E) in relation to the total plus 4.75 mm (No. 4).

$$\text{F\&E Group CPR} = (\text{CPR} \div \#4 \text{ CPR}) \times 100$$

3. Calculate the individual percent retained of each size.

$$\text{F\&E Group Individual Percent Retained (IPR)} = \text{F\&E Group CPR} - \text{Next Larger Group CPR}$$

4. Calculate the percent flat and elongated for each size group.

$$\% \text{ F\&E for Size Group} = [(\text{Mass F\&E Size Group}) / (\text{Size Group Mass})] \times 100$$

5. Calculate the weighted percent for each size to 0.1%.

$$\text{Weighted \% F\&E Size Group} = (\% \text{ F\&E for Size Group} \times \text{F\&E Group IPR}) \div 100$$

6. Calculate the total percentage of F&E by determining the sum of all the weighted % F&E for Size Groups.

7. Report

- Report the total percentage for F&E on Department forms to the nearest whole percent.

Figure 1
ASTM Proportional Caliper



Caliper set to 1:5 ratio



Length Determination

Flat Determination

This page intentionally left blank.

ATM 307 Plastic Fines in Graded Aggregates and Soils by Use of the Sand Equivalent Test

Following are guidelines for the use of WAQTC FOP for AASHTO T 176 by the State of Alaska DOT&PF.

1. Sieve: added to WAQTC FOP under “Apparatus.”

This page intentionally left blank

PLASTIC FINES IN GRADED AGGREGATES AND SOILS BY THE USE OF THE SAND EQUIVALENT TEST

FOP FOR AASHTO T 176

Scope

This procedure covers the determination of plastic fines in accordance with AASHTO T 176-22. It serves as a rapid test to show the relative proportion of fine dust or clay-like materials in fine aggregates (FA) and soils.

Apparatus

- See AASHTO T 176 for a detailed listing of sand equivalent apparatus. Note that the siphon tube and blow tube may be glass or stainless steel as well as copper.
- Graduated plastic cylinder.
- Rubber stopper.
- Irrigator tube.
- Weighted foot assembly: Having a mass of 1000 ± 5 g. There are two models of the weighted foot assembly. The older model has a guide cap that fits over the upper end of the graduated cylinder and centers the rod in the cylinder. It is read using a slot in the centering screws. The newer model has a sand-reading indicator 254 mm (10 in.) above this point and is preferred for testing clay-like materials.
- Bottle: clean, glass or plastic, of sufficient size to hold working solution
- Siphon assembly: The siphon assembly will be fitted to a 4 L (1 gal.) bottle of working calcium chloride solution placed on a shelf 915 ± 25 mm (36 ± 1 in.) above the work surface.
- Measuring can: With a capacity of 85 ± 5 mL (3 oz.).
- Balance or scale: Capacity sufficient for sample mass, accurate to 0.1 percent of the sample mass or readable to 0.1 g and meeting the requirements of AASHTO M 231.
- Funnel: With a wide mouth for transferring sample into the graduated cylinder.
- Quartering cloth: 600 mm (2 ft.) square nonabsorbent cloth, such as plastic or oilcloth.
- Mechanical splitter: See the FOP for AASHTO R 76.
- Strike-off bar: A straightedge or spatula.
- Clock or watch reading in minutes and seconds.
- Manual shaker: A manually operated sand equivalent shaker capable of producing an oscillating motion at a rate of 100 complete cycles in 45 ± 5 seconds, with a hand assisted half stroke length of 127 ± 5 mm (5 ± 0.2 in.). It may be held stable by hand during the shaking operation. It is recommended that this shaker be fastened securely to a firm and level mount, by bolts or clamps, if many determinations are to be made.
- Mechanical shaker: See AASHTO T 176 for equipment and procedure.
- Oven: Capable of maintaining a temperature of $110 \pm 5^\circ\text{C}$ ($230 \pm 9^\circ\text{F}$).
- Thermometer: Calibrated liquid-in-glass or electronic digital type designed for total immersion and accurate to 0.1°C (0.2°F).

- Sieve: 4.75-mm (No. 4) sieve meeting the requirements of the FOP for AASHTO T 27/T 11

Materials

- Stock calcium chloride solution: Obtain commercially prepared calcium chloride stock solution meeting AASHTO requirements.
- Working calcium chloride solution: Make 3.8 L (1 gal) of working solution. Fill the bottle with 2 L (1/2 gal) of distilled or demineralized water, add one 3 oz. measuring can (85 ±5 mL) of stock calcium chloride solution. Agitate vigorously for 1 to 2 minutes. Add the remainder of the water, approximately 2 L (1/2 gal.) for a total of 3.8 L (1 gal) of working solution. Repeat the agitation process. Tap water may be used if it is proven to be non-detrimental to the test and if it is allowed by the agency. The shelf life of the working solution is approximately 30 days. Label working solution with the date mixed. Discard working solutions more than 30 days old.

Note 1: The graduated cylinder filled to 4.4 in. contains 88 mL and may be used to measure the stock solution.

Control

The temperature of the working solution should be maintained at 22 ±3°C (72 ±5°F) during the performance of the test. If field conditions preclude the maintenance of the temperature range, reference samples should be submitted to the Central/Regional Laboratory, as required by the agency, where proper temperature control is possible. Samples that meet the minimum sand equivalent requirement at a working solution temperature outside of the temperature range need not be subject to reference testing.

Sample Preparation

1. Obtain the sample in accordance with the FOP for AASHTO R 90 and reduce in accordance with the FOP for AASHTO R 76.
2. Sieve the sample over the 4.75 mm (No. 4) sieve. If the material is in clods, break it up and re-screen it over a 4.75 mm (No. 4) sieve. Clean all fines from particles retained on the 4.75 mm (No. 4) sieve and include with the material passing that sieve.
3. Split or quarter 1000 to 1500 g of material from the portion passing the 4.75 mm (No. 4) sieve. Use extreme care to obtain a truly representative portion of the original sample.

Note 2: Experiments show that, as the amount of material being reduced by splitting or quartering is decreased, the accuracy of providing representative portions is reduced. It is imperative that the sample be split or quartered carefully. When it appears necessary, dampen the material before splitting or quartering to avoid segregation or loss of fines.

Note 3: All tests, including reference tests, will be performed using Alternative Method No. 2 as described in AASHTO T 176, unless otherwise specified.

4. The sample must have the proper moisture content to achieve reliable results. This condition is determined by tightly squeezing a small portion of the thoroughly mixed sample in the palm of the hand. If the cast that is formed permits careful handling without breaking, the correct moisture content has been obtained.

Note 4: Clean sands having little 75 µm (No. 200), such as sand for Portland Cement Concrete (PCC), may not form a cast.

If the material is too dry, the cast will crumble, and it will be necessary to add water and remix and retest until the material forms a cast. When the moisture content is altered to provide the required cast, the altered sample should be placed in a pan, covered with a lid or with a damp cloth that does not touch the material, and allowed to stand for a minimum of 15 minutes. Samples that have been sieved without being air-dried and still retain enough natural moisture are exempted from this requirement.

If the material shows any free water, it is too wet to test and must be drained and air dried. Mix frequently to ensure uniformity. This drying process should continue until squeezing provides the required cast.

5. Place the sample on the quartering cloth and mix by alternately lifting each corner of the cloth and pulling it over the sample toward the diagonally opposite corner, being careful to keep the top of the cloth parallel to the bottom, thus causing the material to be rolled. When the material appears homogeneous, finish the mixing with the sample in a pile near the center of the cloth.
6. Fill the measuring can by pushing it through the base of the pile while exerting pressure with the hand against the pile on the side opposite the measuring can. As the can is moved through the pile, hold enough pressure with the hand to cause the material to fill the tin to overflowing. Press firmly with the palm of the hand, compacting the material and placing the maximum amount in the can. Strike off the can level with the straightedge or spatula.
7. When required, repeat steps 5 and 6 to obtain additional samples.

Procedure

1. Start the siphon by forcing air into the top of the solution bottle through the tube while the pinch clamp is open. Siphon 101.6 ± 2.5 mm (4 ± 0.1 in.) of working calcium chloride solution into the plastic cylinder.
2. Pour the prepared test sample from the measuring can into the plastic cylinder, using the funnel to avoid spilling.
3. Tap the bottom of the cylinder sharply on the heel of the hand several times to release air bubbles and to promote thorough wetting of the sample.
4. Allow the wetted sample to stand undisturbed for 10 ± 1 minutes.
5. At the end of the 10-minute period, stopper the cylinder and loosen the material from the bottom by simultaneously partially inverting and shaking the cylinder.
6. After loosening the material from the bottom of the cylinder, shake the cylinder and contents by any one of the following methods:
 - a. Mechanical Method – Place the stoppered cylinder in the mechanical shaker, set the timer, and allow the machine to shake the cylinder and contents for 45 ± 1 seconds.

Caution: Agencies may require additional operator qualifications for the next two methods.

- b. **Manual Method** – Secure the stoppered cylinder in the three spring clamps on the carriage of the manually-operated sand equivalent shaker and set the stroke counter to zero. Stand directly in front of the shaker and force the pointer to the stroke limit marker painted on the backboard by applying an abrupt horizontal thrust to the upper portion of the right hand spring strap.

Remove the hand from the strap and allow the spring action of the straps to move the carriage and cylinder in the opposite direction without assistance or hindrance. Apply enough force to the right-hand spring steel strap during the thrust portion of each stroke to move the pointer to the stroke limit marker by pushing against the strap with the ends of the fingers to maintain a smooth oscillating motion. The center of the stroke limit marker is positioned to provide the proper stroke length and its width provides the maximum allowable limits of variation.

Proper shaking action is accomplished when the tip of the pointer reverses direction within the marker limits. Proper shaking action can best be maintained by using only the forearm and wrist action to propel the shaker. Continue shaking for 100 strokes.

- c. Hand Method – Hold the cylinder in a horizontal position and shake it vigorously in a horizontal linear motion from end to end. Shake the cylinder 90 cycles in approximately 30 seconds using a throw of 229

mm \pm 25 mm (9 \pm 1 in.). A cycle is defined as a complete back and forth motion. To properly shake the cylinder at this speed, it will be necessary for the operator to shake with the forearms only, relaxing the body and shoulders.

7. Set the cylinder upright on the **worktable** and remove the stopper.
8. Insert the irrigator tube in the cylinder and rinse material from the cylinder walls as the irrigator is lowered. Force the irrigator through the material to the bottom of the cylinder by applying a gentle stabbing and twisting action while the working solution flows from the irrigator tip. Work the irrigator tube to the bottom of the cylinder as quickly **as possible, as** it becomes more difficult to do this as the washing proceeds. This flushes the fine material into suspension above the coarser sand particles.

Continue to apply a stabbing and twisting action while flushing the fines upward until the cylinder is filled to the 381 mm (15 in.) mark. Then raise the irrigator slowly without shutting off the flow so that the liquid level is maintained at about 381 mm (15 in.) while the irrigator is being withdrawn. Regulate the flow just before the irrigator is entirely withdrawn and adjust the final level to 381 mm (15 in.).

Note 5: Occasionally the holes in the tip of the irrigator tube may become clogged by a particle of sand. If the obstruction cannot be freed by any other method, use a pin or other sharp object to force it out, using extreme care not to enlarge the size of the opening. Also, keep the tip sharp as an aid to penetrating the sample.

9. Allow the cylinder and contents to stand undisturbed for 20 minutes \pm 15 seconds. Start timing immediately after withdrawing the irrigator tube.

Note 6: Any vibration or movement of the cylinder during this time will interfere with the normal settling rate of the suspended clay and will cause an erroneous result.

10. Clay and sand readings:

- a. At the end of the 20-minute sedimentation period, read and record the level of the top of the clay suspension. This is referred to as the clay reading.
- b. **If no clear line of demarcation has formed at the end of the 20-minute sedimentation period, allow the sample to stand undisturbed until a clay reading can be obtained, then immediately read and record the level of the top of the clay suspension and the total sedimentation time. If the total sedimentation time exceeds 30 minutes, rerun the test using three individual samples of the same material. Read and record the clay column height of the sample requiring the shortest sedimentation period only. Once a sedimentation time has been established, subsequent tests will be run using that time. The time will be recorded along with the test results on all reports.**
- c. After the clay reading has been taken, place the weighted foot assembly over the cylinder and gently lower the assembly until it comes to rest on the sand. Do not allow the indicator to hit the mouth of the cylinder as the assembly is being lowered. Subtract 254 mm (10 in.) from the level indicated by the extreme top edge of the indicator and record this value as the sand reading.
- d. If clay or sand readings fall between 2.5 mm (0.1 in.) graduations, record the level of the higher graduation as the reading. For example, a clay reading that appears to be 7.95 would be recorded as 8.0; a sand reading that appears to be 3.22 would be recorded as 3.3.
- e. If two Sand Equivalent (SE) samples are run on the same material and the second varies by more than \pm 4, based on the first cylinder result, additional tests shall be run.
- f. If three or more Sand Equivalent (SE) samples are run on the same material, average the results. If an individual result varies by more than \pm 4, based on the average result, additional tests shall be run.

Calculations

Calculate the SE to the nearest 0.1 using the following formula:

$$SE = \frac{\text{Sand Reading}}{\text{Clay Reading}} \times 100$$

Example

$$SE = \frac{3.3}{8.0} \times 100 = 41.25 \text{ or } 41.3 \quad \text{Report 42}$$

Given:

Sand Reading = 3.3

Clay Reading = 8.0

Note 7: This example reflects the use of equipment made with English units. At this time, equipment made with metric units is not available.

Report the SE as the next higher whole number. In the example above, the 41.3 would be reported as 42. An SE of 41.0 would be reported as 41.

When averaging two or more samples, raise each calculated SE value to the next higher whole number (reported value) before averaging.

Example:

calculated value 1 = 41.3

calculated value 2 = 42.8

These values are reported as 42 and 43, respectively.

Average the two reported values:

$$\text{Average SE} = \frac{42 + 43}{2} = 42.5 \quad \text{Report 43}$$

If the average value is not a whole number, raise it to the next higher whole number.

Report

- On forms approved by the agency
- Sample ID
- Results to the next higher whole number
- Sedimentation time if over 20 minutes

This page left intentionally left blank.

ATM 308 Specific Gravity and Absorption of Coarse Aggregate

Following are guidelines for the use of WAQTC FOP for AASHTO T 85 by the State of Alaska DOT&PF.

1. Add to Terminology:

Size Fraction – Material retained on a single sieve, excluding material that would be retained on larger sieves.

2. When Specific Gravity is determined on portions of the sample, determine the total sample specific gravity with the following formula:

$$G = \frac{100}{\frac{P_1}{G_1} + \frac{P_2}{G_2} + \dots + \frac{P_n}{G_n}}$$

Where:

G= average specific gravity

P₁, P₂, P_n, = mass percentages of each portion tested from the original sample;

G₁, G₂, G_n, = specific gravity values of each portion tested from the original sample;

3. The sample size shown in Table 1 represents the material that will be tested. When the material contains both coarse and fine, or there will be material rejected over either the No. 4 or ¾ in. sieves; the size of the field sample must be increased to compensate for the rejected material.
4. When a specific size fraction of an aggregate is tested, the minimum mass of the test sample shall be the difference between the masses prescribed for the maximum and minimum sizes of the fraction.
5. Between step 4 and 5 of procedure:
Re-inspect the immersion tank to insure the water level is at the overflow outlet height.

This page intentionally left blank.

SPECIFIC GRAVITY AND ABSORPTION OF COARSE AGGREGATE FOP FOR AASHTO T 85

Scope

This procedure covers the determination of specific gravity and absorption of coarse aggregate in accordance with AASHTO T 85-22. Specific gravity may be expressed as bulk specific gravity (G_{sb}), bulk specific gravity, saturated surface dry (G_{sb} SSD), or apparent specific gravity (G_{sa}). G_{sb} and absorption are based on aggregate after soaking in water. This procedure is not intended to be used with lightweight aggregates.

Terminology

Absorption – the increase in the mass of aggregate due to water being absorbed into the pores of the material, but not including water adhering to the outside surface of the particles, expressed as a percentage of the dry mass. The aggregate is considered “dry” when it has been maintained at a temperature of $110 \pm 5^{\circ}\text{C}$ ($230 \pm 9^{\circ}\text{F}$) for sufficient time to remove all uncombined water.

Saturated Surface Dry (SSD) – condition of an aggregate particle when the permeable voids are filled with water, but no water is present on exposed surfaces.

Specific Gravity – the ratio of the mass, in air, of a volume of a material to the mass of the same volume of gas-free distilled water at a stated temperature.

Apparent Specific Gravity (G_{sa})– the ratio of the mass, in air, of a volume of the impermeable portion of aggregate to the mass of an equal volume of gas-free distilled water at a stated temperature.

Bulk Specific Gravity (G_{sb})– the ratio of the mass, in air, of a volume of aggregate (including the permeable and impermeable voids in the particles, but not including the voids between particles) to the mass of an equal volume of gas-free distilled water at a stated temperature.

Bulk Specific Gravity (SSD) (G_{sb} SSD) – the ratio of the mass, in air, of a volume of aggregate, including the mass of water within the voids filled to the extent achieved by submerging in water for 15 to 19 hours (but not including the voids between particles), to the mass of an equal volume of gas-free distilled water at a stated temperature.

Apparatus

- Balance or scale: with a capacity of 5 kg, sensitive to 0.1 g. Meeting the requirements of AASHTO M 231.
- Sample container: a wire basket of 3.35 mm (No. 6) or smaller mesh, with a capacity of 4 to 7 L (1 to 2 gal) to contain aggregate with a nominal maximum size of 37.5 mm (1 1/2 in.) or smaller; or a larger basket for larger aggregates, or both.
- Water tank: watertight and large enough to completely immerse aggregate and basket, equipped with an overflow valve to keep water level constant.
- Suspension apparatus: wire used to suspend apparatus shall be of the smallest practical diameter.
- Sieves: 4.75 mm (No. 4) or other sizes as needed, meeting the requirements of FOP for AASHTO T 27/T 11.
- Large absorbent towel.

Sample Preparation

1. Obtain the sample in accordance with the FOP for AASHTO R 90 (see Note 1).
2. Mix the sample thoroughly and reduce it to the approximate sample size required by Table 1 in accordance with the FOP for AASHTO R 76.
3. Reject all material passing the appropriate sieve by dry sieving.
4. Thoroughly wash sample to remove dust or other coatings from the surface.
5. Dry the test sample to constant mass according to the FOP for AASHTO T 255/T 265 at a temperature of 110 ±5°C (230 ±9°F) and cool in air at room temperature for 1 to 3 hours.

Note 1: Where the absorption and specific gravity values are to be used in proportioning concrete mixtures in which the aggregates will be in their naturally moist condition, the requirement for initial drying to constant mass may be eliminated, and, if the surfaces of the particles in the sample have been kept continuously wet until test, the 15-to-19-hour soaking may also be eliminated.

6. Re-screen the sample over the appropriate sieve. Reject all material passing that sieve.
7. The sample shall meet or exceed the minimum mass given in Table 1.

Note 2: If this procedure is used only to determine the G_{sb} of oversized material for the FOP for AASHTO T 99 / T 180, the material can be rejected over the appropriate sieve. For T 99 / T 180 Methods A and B, use the 4.75 mm (No. 4) sieve; T 99 / T 180 Methods C and D use the 19 mm (3/4 in).

Table 1

<i>Nominal Maximum Size*</i>		<i>Minimum Mass of Test Sample</i>	
<i>mm</i>	<i>(in.)</i>	<i>g</i>	<i>(lb)</i>
75	(3)	18,000	(40)
63	(2 1/2)	12,000	(26)
50	(2)	8000	(18)
37.5	(1 1/2)	5000	(11)
25.0	(1)	4000	(8.8)
19.0	(3/4)	3000	(6.6)
12.5	(1/2) or less	2000	(4.4)

* One sieve larger than the first sieve to retain more than 10 percent of the material using an agency specified set of sieves based on cumulative percent retained. Where large gaps in specification sieves exist, intermediate sieve(s) may be inserted to determine nominal maximum size.

Procedure

1. Immerse the aggregate in water at room temperature for a period of 15 to 19 hours.

Note 3: When testing coarse aggregate of large nominal maximum size requiring large test samples, it may be more convenient to perform the test on two or more subsamples, and then combine the values obtained.

2. Place the empty basket into the water bath and attach to the balance. Inspect the immersion tank to ensure the water level is at the overflow outlet **height and basket is fully submerged**. Tare the balance with the empty basket attached in the water bath.

- Remove the test sample from the water and roll it in a large absorbent cloth until all visible films of water are removed. Wipe the larger particles individually. If the test sample dries past the SSD condition, immerse in water for 30 min, and then resume the process of surface-drying.

Note 4: A moving stream of air may be used to assist in the drying operation but take care to avoid evaporation of water from aggregate pores.

- Determine the SSD mass of the sample, and record this and all subsequent masses to the nearest 0.1 g or 0.1 percent of the sample mass, whichever is greater. Designate this mass as “B.”
- Immediately place the SSD test sample in the sample container and weigh it in water maintained at $23.0 \pm 1.7^\circ\text{C}$ ($73.4 \pm 3^\circ\text{F}$). Shake the container to release entrapped air before recording the weight. Re-inspect the immersion tank to ensure the water level is at the overflow outlet **height and basket is fully submerged**. Designate this submerged weight as “C.”

Note 5: The container should be immersed to a depth sufficient to cover it and the test sample during mass determination. Wire suspending the container should be of the smallest practical size to minimize any possible effects of a variable immersed length.

- Remove the sample from the basket. Ensure all material has been removed. Place in a container of known mass.
- Dry the test sample to constant mass according to the FOP for AASHTO T 255 / T 265 at $110 \pm 5^\circ\text{C}$ ($230 \pm 9^\circ\text{F}$) and cool in air at room temperature for 1 to 3 hours.
- Determine and record the dry mass. Designate this mass as “A.”

Calculations

Perform calculations and determine values using the appropriate formula below.

Bulk specific gravity (G_{sb})

$$G_{sb} = \frac{A}{B - C}$$

Bulk specific gravity, SSD ($G_{sb\text{SSD}}$)

$$G_{sb\text{SSD}} = \frac{B}{B - C}$$

Apparent specific gravity (G_{sa})

$$G_{sa} = \frac{A}{A - C}$$

Absorption

$$\text{Absorption} = \frac{B - A}{A} \times 100$$

Where:

- A = oven dry mass, g
- B = SSD mass, g
- C = weight in water, g

Sample Calculations

Sample	A	B	C	B - C	A - C	B - A
1	2030.9	2044.9	1304.3	740.6	726.6	14.0
2	1820.0	1832.5	1168.1	664.4	651.9	12.5
3	2035.2	2049.4	1303.9	745.5	731.3	14.2

Sample	G _{sb}	G _{sb} SSD	G _{sa}	Absorption
1	2.742	2.761	2.795	0.7
2	2.739	2.758	2.792	0.7
3	2.730	2.749	2.783	0.7

These calculations demonstrate the relationship between G_{sb} , G_{sb} SSD, and G_{sa} . G_{sb} is always lowest since the volume includes voids permeable to water. G_{sb} SSD is always intermediate. G_{sa} is always highest since the volume does not include voids permeable to water. When running this test, check to make sure the values calculated make sense in relation to one another.

Report

- On forms approved by the agency
- Sample ID
- Specific gravity values to the nearest 0.001
- Absorption to the nearest 0.1 percent

ATM 309 Relative Standard Density of Soils by the Control Strip Method

1. Scope

This method describes a procedure for determining the relative standard dry density of a material by the control strip testing method. This is applicable to soils and soil mixtures.

Standard density values established with this method are GAUGE-SPECIFIC and must be determined for each gauge used in acceptance testing of the material. Assurance checks should be of uncorrected wet density readings.

2. Significance and Use

Site conditions and/or logistics may make determining the standard density difficult with conventional test methods used in the laboratory. When these problems occur a method that allows the determination of a relative standard density in the field can facilitate the verification of compaction efforts. This method describes a procedure to determine the relative standard density to be used in these circumstances.

3. Apparatus

- Nuclear Moisture/Density Gauge—Calibrate and standardize in accordance with ATM 213.
- Compaction equipment that meets the requirements of the contract and of sufficient size and compaction energy to compact the material.

4. Site Preparation

1. The Engineer will designate the location of the control strip, as well as minimum compaction equipment to be used. If size of control strip is not specified, use a 12 ft. x 300 ft. control strip.
2. A representative lift of the material being evaluated will be placed and prepared for compaction.

5. Procedure

1. Attention should be paid to the requirements of the material being placed so that moisture requirements are maintained in an acceptable range.
2. A minimum of 3 test locations will be selected with-in the control strip. The locations will be in the middle 1/2 of the control strip and at least 12 in from the edge of the control strip. The Engineer will select test locations.
3. The locations will be marked in such a way as not to be lost during the compaction of the control strip. This can be accomplished by marking the side of the strip with stakes or surveyors tape, or by marking with paint beside the location on the control strip.
4. Care should be taken when choosing and preparing the test location, so that it is flat and the surface voids filled. If necessary, use a small quantity of native fines to fill the voids. The thickness of added fines shall not exceed 1/8 in.
5. Tests shall be taken with nuclear moisture/density gauge in backscatter mode. A test will consist of the average of two 15 second readings (fast mode), or one 1 minute reading. Record all readings, and in the case of the 15 second readings record the average dry density determination at each location.
6. After the first pass with the compaction equipment, an initial density is determined by averaging the densities of the selected test locations.

Note 1: One pass of the roller will be defined as one roll over the location.

7. After each subsequent pass and for each piece of compaction equipment used, a test is taken at each location, recorded and then averaged to produce the density value for that pass.
8. Continue the compaction and testing cycle until there is a pass with less than 16 kg/m³ (1 lb/ft³) increase in the average dry density of the test locations; and a second consecutive pass with less than 16 kg/m³ (1 lb/ft³) increase in the average density of the test locations.
9. Select ten random locations on the completed control strip, and test by averaging two one minute readings or one four minute reading, at each location in accordance with ATM 213. Average the results from the ten locations and this value will be the relative standard dry density for this material. Tests shall be performed in direct transmission mode when practicable.

Note 2: It may be necessary to repeat the procedure for additional roller types depending on the material to be tested and the requirements of sequencing for the finished surface.

10. Additional control strips may be required if there are changes in the material, lift thickness or compaction equipment.

6. Calculations

The Relative Standard Dry Density value will be calculated as follows:

$$D_s = \frac{(A_1 + A_2 + A_3 + A_4 + A_5 + A_6 + A_7 + A_8 + A_9 + A_{10})}{10}$$

Where:

D_s = Relative Standard Dry Density for the material.

A_n = Average Dry Density for random test location n.

7. Report

- Report the average dry density for each pass
- Report the relative standard dry density to the nearest 0.1 lb/ft³



**STATE OF ALASKA
DOT & PF**

**RELATIVE STANDARD DENSITY OF SOILS
by the CONTROL STRIP METHOD
ATM 309 - FIELD WORKSHEET**

Acceptance Information

Sample No: _____

Project Name: _____

Federal No: _____ AKSAS No: _____

Material: _____ Source: _____

Item No: _____ Gauge Model: _____ Gauge S/N: _____

Lane: _____ Width: _____ Station to Station: _____ Std. Count: _____

Date: _____

**Initial (Control Strip) readings shall be taken in backscatter position. The final (ten random location) readings shall be performed in direct transmission when practicable. All readings are to be Dry Density.*

***Continue the compaction & testing cycle until there is a pass with less than 1 lb/ft³ increase in the average dry density of the test locations, and a second consecutive pass with less than 1 lb/ft³ increase in the average dry density of the test locations.*

Equipment:	Pass #:	*Location 1	*Location 2	*Location 3	**Average	Remarks:
Roller #1:	1					
	2					
	Roller Brand:	3				
	Roller Model Number:	4				
	Roller Type:	5				
		6				
	Compaction Mode: Vibe or Static (Circle)	7				
Roller #2:	1					
	2					
	Roller Brand:	3				
	Roller Model Number:	4				
	Roller Type:	5				
		6				
	Compaction Mode: Vibe or Static (Circle)	7				

Locations → 1 2 3 4 5 6 7 8 9 10

Reading 1 (1 minute)											Relative Standard Density
Reading 2 (1 minute)											
Average Dry Density											

Reading 1 (% moisture)											Average Moisture
Reading 2 (% moisture)											
Average % Moisture											

Remarks: _____

Signature / Qualification No / Date: _____

Checked by / Date: _____

Rev. 06/01/2019



**STATE OF ALASKA
DOT & PF
Construction**

**ATM 213 - In-place Density Report
for ATM 309- Control Strip SD**

Acceptance Information Assurance

Project Name: _____
 State No: _____
 Material _____ Source _____
 Item No. _____ Spec. _____ Gauge Serial No. _____

FIELD DENSITY TEST NUMBER								
STATION								
STATION								
STATION								
C/L REFERENCE								
C/L REFERENCE								
C/L REFERENCE								
GRADE REFERENCE								
QUANTITY REPRESENTED								
DATE TESTED								
STANDARD DENSITY BY: <input type="checkbox"/> ATM 309								
Lab Number								
(A) Standard Density (Field Established)								
Optimum Moisture	N/A	N/A	N/A	N/A				
(B) Bulk Specific Gravity	N/A	N/A	N/A	N/A				
DENSITY DETERMINATION								
Probe Depth	Backscatter		Backscatter		Backscatter		Backscatter	
	Reading #1	Reading#2	Reading #1	Reading #2	Reading #1	Reading#2	Reading #1	Reading#2
Wet Density, lbm/f ³	Gauge Readings							
Wet Density, lbm/f ⁴	Gauge Readings							
Wet Density, lbm/f ⁵	Gauge Readings							
(C) Average Wet Density								
% COMPACTION	C/A x 100							

REMARKS: _____

Signature: _____
 Checked by: _____
 Date: _____

ATM 312 Nordic Abrasion Value of Coarse Aggregate

1. Scope

This method describes the test procedure for the simulation of the abrasive action of traffic on coarse aggregates used in a surface layer to determine the ability of the aggregate to resist wear by abrasion from studded tires.

The test shall be performed on the specific size aggregate fraction of 11.2 to 16.0 mm (7/16" to 5/8")

Note 1: Variations from this size range will not give consistent results.

The test is applicable to crushed and uncrushed natural and artificial aggregates.

This test method involves potentially hazardous materials, operations and equipment. This method does not purport to address all of the safety problems associated with its use.

2. Principle

A specimen of an individual size fraction is rotated in a steel drum that contains a steel ball charge and water. The interior of the drum has three ribs, which add to the abrading. The drum is rolled causing the contents within to tumble. After the specified number of revolutions, the contents are removed from the drum and the aggregate is sieved over a 2.00 mm (No. 10) sieve. The measure of wear, as a percentage loss, is calculated.

3. Apparatus

- Testing machine conforming to the design shown in Figure 1.
- The test drum shall have an inside diameter of 206.5 ± 2 mm and an inside length of 335 ± 1 mm. The drum shall be water-tight and made of a seamless steel tube conforming to grade TS 5 of ISO 2604-2, of outside diameter 219.1 mm and wall thickness of 6.3 mm. The drum shall rotate centrally with the axis in a horizontal position at a rate of 90 ± 3 rpm. A revolution counter shall automatically stop the rotation after 5400 revolutions.

Three ribs, each with a length of 333 ± 1 mm, shall be equally spaced around the internal circumference of the drum. The three ribs shall be removable and made from spring steel as specified in ISO 683-14 and designed in accordance with Figure 1. The ribs, prior to their use in a test, shall be preground in the drum for 25 h using a hard aggregate, together with the normal proportions of steel balls and water.

Note 2: Over time, and with repeated use, the ribs will wear and their action will change. Each rib shall be replaced, when its loss in original mass exceeds 15 g.

- Steel balls (7000 ± 10 g), 14.50-15.01 mm diameter, of a hardness between 62 and 65 HRC, as specified in ISO 3290.
- Gauge to control minimum steel ball size, e.g. two parallel bars 14.50 mm apart.
- Magnet (optional) for removal of the steel ball charge from the test specimen after abrasion.

Note 3: Do not use too strong a magnet as the steel balls may become magnetized.

- Oven capable of maintaining a uniform temperature of 110 ± 5 °C (230 ± 9 °F).
- Balance or scale: Capacity sufficient for the principle sample mass, readable to 0.1 percent or 0.1 g, of the total sample mass and meeting the requirements of AASHTO M 231.
- Sieves of the following sizes: 2.00 mm, 11.2 mm, and 16.0 mm (No. 10, 7/16" and 5/8").
- Bucket.

- Washing device

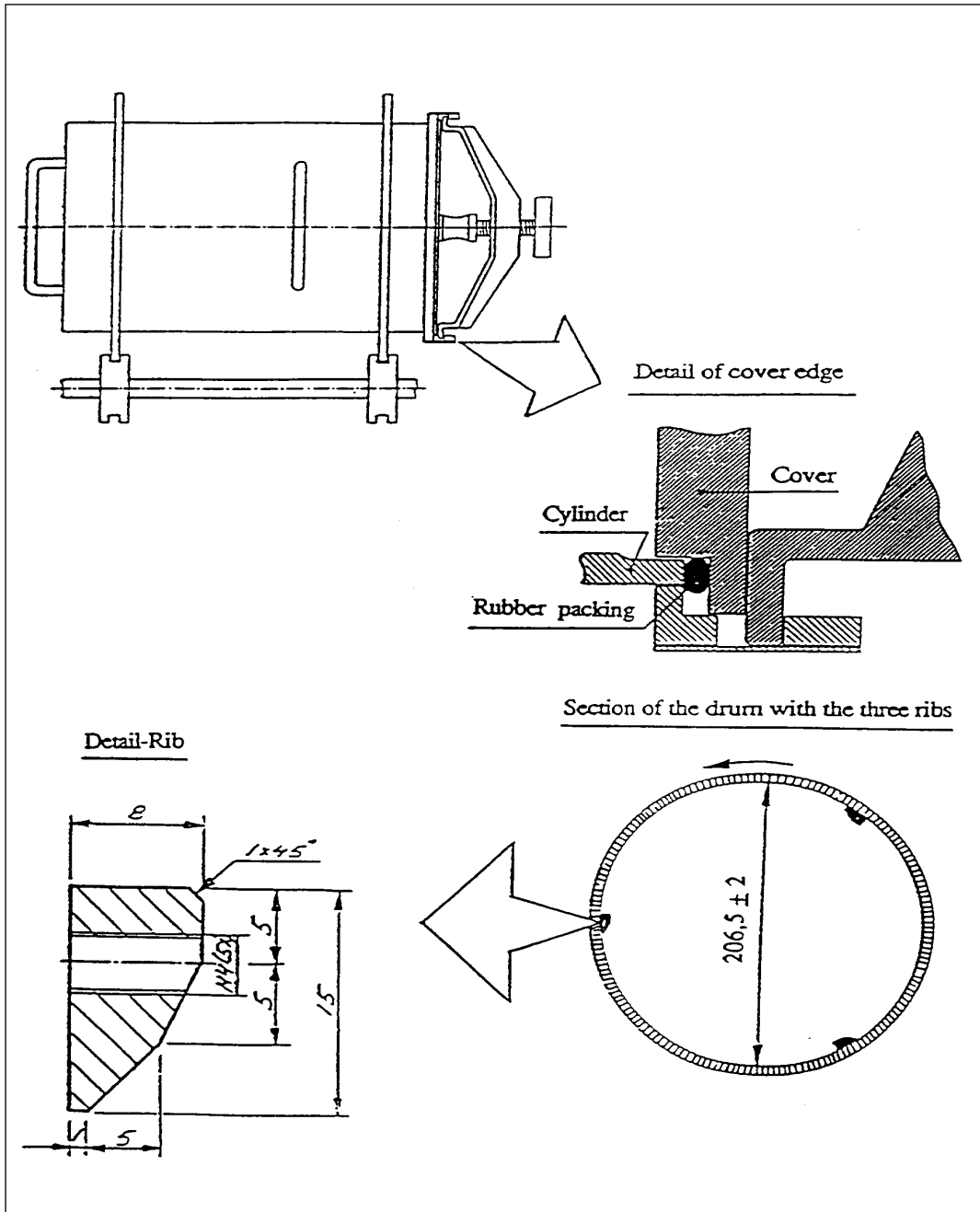

Figure 1
All Dimensions in mm

4. Sampling

Obtain a sample in accordance with WAQTC FOP for AASHTO T 2 (ASTM D75).

5. Preparation of Test Sample

Unprocessed Aggregate

1. Separate the sample on the 19 mm (3/4") sieve by hand or mechanical shaker, sieving the material for 5 minutes. Discard the minus 19 mm (3/4") material.
2. Crush the plus 19 mm (3/4") material, or a representative portion obtained in accordance with WAQTC FOP for AASHTO T 248, to pass the 19 mm (3/4") sieve.
3. Separate the crushed material into a test sample, using 16 mm (5/8") sieve and 11.2 mm (7/16") sieves, in accordance with WAQTC FOP for AASHTO T 27/T 11. Discard all particles retained on the 16 mm (5/8") sieve and all the particles passing the 11.2 mm (7/16") sieve.
4. Proceed to Step 2 below.

Processed (already crushed) Aggregate

1. Separate the material into a test sample, using 16 mm (5/8") and 11.2 mm (7/16") sieves, in accordance with WAQTC FOP for AASHTO T 27/T 11. Discard all particles retained on the 5/8" (16 mm) sieve and all the particles passing the 11.2 mm (7/16") sieve.
2. The test sample must have no more than 8 percent Flat and Elongated particles when tested in accordance with ATM 306 using a caliper ratio of 1:5. Remove Flat and Elongated particles until the test sample meets this requirement.
3. Reduce the test sample to a minimum of 3500 g in accordance with WAQTC FOP for AASHTO T 248.
4. Wash the sample and dry to a constant mass in accordance with WAQTC FOP for AASHTO T 255/T 265.
5. Determine the apparent specific gravity of the test sample, or a portion thereof, in accordance with WAQTC FOP for AASHTO T 85.
6. Determine the individual test specimen mass by:

$$m_i = \frac{P_i}{2.66} \times 1000$$

Where:

m_i = mass of the individual test specimen

p_i = apparent specific gravity of the test sample

7. Batch 3 test specimens at the calculated weight ± 5 g.

6. Procedure

1. Place the steel ball charge (7000 ± 10 g) and the test specimen in the drum and add (2000 ± 10) ml. of water.
2. Rotate the drum at a speed of 90 ± 3 rpm for 5400 ± 10 revolutions.

3. After the specified number of revolutions, discharge the contents (steel ball charge, test specimen, and water) from the drum into a container.
4. Remove the steel ball charge with a magnet, being careful not to degrade and or lose aggregate particles.
5. Wash the remaining contents (test specimen and water) over a 2.00 mm (No. 10) sieve.

Note 4: To avoid overloading the sieve, it may be necessary to divide the test specimen into smaller portions.

6. Dry the test specimen fractions retained on the 2.00 mm (No. 10) sieve, to a constant mass in accordance with WAQTC FOP for AASHTO T 255 and weigh to the nearest 0.1 g.

7. Calculation and Expression of Results

1. Calculate the individual Nordic Abrasion Values (A_n) to the nearest 0.1 percent as follows:

$$A_n = \left(\frac{M_i - M_f}{M_i} \right) \times 100$$

Where

A_n = Nordic Abrasion Values

M_i = Initial dry mass of the test specimen.

M_f = Final dry mass of the test specimen after the test.

2. Compute and record the average of the individual Nordic Abrasion Values to the nearest 0.1 percent.

8. Report

- The individual and average Nordic Abrasion values shall be reported on Department forms to the nearest 0.1 percent.

ATM 313 Degradation Value of Aggregates

1. Scope

This test method describes the procedure for determining the durability of an aggregate. The durability of an aggregate as measured by the Degradation Value indicates the relative resistance of an aggregate to produce detrimental clay-like fines when subjected to a prescribed abrasion process in the presence of distilled or demineralized water.

2. Apparatus

- Jaw crusher with 150 mm (6") capacity.
- Sieves of the following sizes: 12.5 mm (½"), 6.3 mm (¼"), 2.00 mm (No. 10) and 75 µm (No. 200). Sieves shall conform to ASTM E11.
- Balance or scale: Capacity sufficient for the principle sample mass, readable to 0.1 percent or 0.1 g of the total sample mass and meeting the requirements of AASHTO M 231.
- 200 mm (8") sieve shaker with 45 mm (1¾") throw on cam at 285 ± 10 oscillations per minute.
- General Laboratory Interval Timer to control On-Off operation of sieve shaker. Timer will have a minimum 20 minute range accurate to ± 5 seconds.
- Plastic canister 190 mm (7 ½") in diameter and 150 mm (6") high, having a flat bottom; or metal washing vessel conforming to AASHTO T 210 - 5.1.
- Distilled or demineralized water maintained at $22 \pm 3^\circ\text{C}$ ($72 \pm 5^\circ\text{F}$).
- Sample Washing Apparatus, consisting of a ring stand and ring capable of mounting a 230 mm mouth funnel with a 2.00 mm (No. 10) and 75 µm (No. 200) sieve setting on top of the funnel and a graduated cylinder calibrated at 500 ml with a rubber stopper.
- Graduated cylinder or pipette with 10 ml capacity graduated in 1 ml increments.
- Stock Sand Equivalent Solution prepared in accordance with WAQTC FOP for AASHTO T 176, using distilled water only. This solution should be stored in dark or opaque containers and protected from direct sunlight and heat. Solutions that have turned cloudy or formed precipitates will be discarded.
- Standard Sand Equivalent Cylinder with rubber stopper as described in WAQTC FOP for AASHTO T 176.
- Timer or Stopwatch, preferably with an alarm to indicate end of timed interval.
- Miscellaneous equipment including 500 ml wash bottle with a fine spray nozzle, pans, scoops, etc.

3. Degradation Test Area

The degradation test area must be free of vibration and direct sunlight, and maintained at a temperature of $22 \pm 3^\circ\text{C}$ ($72 \pm 5^\circ\text{F}$).

4. Sample Preparation

1. Unprocessed Aggregate
 - a. Separate the aggregate on the 12.5 mm (½") sieve by hand or by mechanical shaker, sieving the material for 5 minutes. Discard the minus 12.5 mm (½") material unless required for other testing.

- b. Crush the plus 12.5 mm (½") aggregate, or a representative portion obtained in accordance with WAQTC FOP for AASHTO T 248, to pass the 12.5 mm (½") sieve.
 - c. Proceed to Step 2 and process the same as already crushed aggregate.
2. Processed (already crushed) Aggregate
 - a. Separate the material by hand sieving or by mechanical shaker, sieving the material for 5 minutes, into 2 size groups: minus 12.5 mm (½") to plus 6.3 mm (¼") and minus 6.3 mm (¼") to plus 2.00 mm (No. 10).
 - b. Reduce each size grouping to a representative sample in accordance with WAQTC FOP for AASHTO T 248, Method A, such that there will be a minimum of 500 grams after washing.
 - c. Wash each size grouping over a 2.00 mm (No. 10) sieve and dry to a constant mass in accordance with WAQTC FOP for AASHTO T 255/T 265.
 - d. Weigh out a 500 ±1 g portion of each size grouping.

5. Procedure

1. Combine both sample portions in the plastic canister, add 200 ml of distilled or demineralized water and cover tightly. Do not allow the sample to soak more than 5 minutes before testing.
2. Place the canister in the degradation sieve shaker and run for 20 minutes ±5 seconds. Do not allow the sample to set for more than 5 minutes after agitation is completed.
3. Remove the canister and wash the material through nested 2.00 mm (No. 10) and 75 µm (No. 200) sieves. Continue washing until the wash water is clear and has reached the 500-ml mark on the graduated cylinder.
4. In instances where highly degradable materials are encountered and the sample cannot be washed clean with 500-ml. of water:
 - a. Continue washing using water sparingly, until the wash water is clear. If a change in receiver cylinders is required, be very careful not to lose any of the wash water.
 - b. To achieve the required 500 ml. volume, allow the wash water to settle until clear, then siphon or pipette off the excess water, being careful not to remove any of the settled material.
 - c. Use of a centrifuge to settle the material is allowed but extreme care must be taken to preclude any loss of material in transferring from the cylinders to the centrifuge bottles and then back to a single cylinder. The solution must be brought to a volume of 500 ml before proceeding to Step 5. Removal of extra water by oven-dried evaporation is not allowed.
5. Place the Sand Equivalent Cylinder upright in a vibration free area out of direct sunlight. Measure and pour 7 ml of the Stock Sand Equivalent Solution into the cylinder.
6. Bring all of the solids in the 500 ml of wash water into suspension by capping the graduated cylinder with the palm of the hand or a rubber stopper, then turning the cylinder upside down and right side up allowing the bubble to traverse from one end to the other and back again. This is one cycle. Repeat this cycle 10 times as rapidly as possible (approximately 35 seconds).
7. Immediately pour the solution into the Sand Equivalent Cylinder, fill to the 15 mark, and plug with a rubber stopper.
8. Mix the contents of the Sand Equivalent Cylinder by turning the cylinder upside down and right side up allowing the bubble to traverse from one end to the other and back again. This is one cycle. Repeat this cycle 20 times as rapidly as possible (approximately 60 seconds).

9. Place the cylinder on a vibration free platform out of direct sunlight, remove stopper and immediately start the timer or stopwatch that is pre-set for 20 minutes.
10. After 20 minutes, immediately read and record the height of the sediment to the nearest 0.1 graduation.

6. Calculations

Determine the Degradation Value using the following formula, or by using Table 1 on next page which is derived from the formula.

$$D = \left(\frac{15 - H}{15 + 1.75H} \right) \times 100$$

Where:

D = Degradation value.

H = Height of sediment in cylinder.

Values may range from 0 to 100 with high values representing more suitable material. The formula and chart place doubtful materials at about the midrange (30-70) of the scale, with poor ones below and good ones above that range.

7. Report

- Report degradation values to the nearest whole number.

Table 1
Degradation Value, "D"

H	D	H	D	H	D	H	D	H	D
0.1	98	3.1	58	6.1	35	9.1	19	12.1	8
0.2	96	3.2	57	6.2	34	9.2	19	12.2	8
0.3	95	3.3	56	6.3	33	9.3	18	12.3	7
0.4	93	3.4	55	6.4	33	9.4	18	12.4	7
0.5	91	3.5	54	6.5	32	9.5	17	12.5	7
0.6	90	3.6	54	6.6	32	9.6	17	12.6	6
0.7	88	6.7	53	6.7	31	9.7	17	12.7	6
0.8	87	3.8	52	6.8	30	9.8	16	12.8	6
0.9	85	3.9	51	6.9	30	9.9	16	12.9	6
1.0	84	4.0	50	7	29	10.0	15	13.0	5
1.1	82	4.1	49	7.1	29	10.1	15	13.1	5
1.2	81	4.2	48	7.2	28	10.2	15	13.2	5
1.3	79	4.3	48	7.3	28	10.3	14	13.3	4
1.4	78	4.4	47	7.4	27	10.4	14	13.4	4
1.5	77	4.5	46	7.5	27	10.5	13	13.5	4
1.6	75	4.6	45	7.6	26	10.6	13	13.6	4
1.7	74	4.7	44	7.7	26	10.7	13	13.7	3
1.8	73	4.8	44	7.8	25	10.8	12	13.8	3
1.9	71	4.9	43	7.9	25	10.9	12	13.9	3
2.0	70	5.0	42	8	24	11.0	12	14.0	3
2.1	69	5.1	41	8.1	24	11.1	11	14.1	2
2.2	68	5.2	41	8.2	23	11.2	11	14.2	2
2.3	67	5.3	40	8.3	23	11.3	11	14.3	2
2.4	66	5.4	39	8.4	22	11.4	10	14.4	1
2.5	65	5.5	39	8.5	22	11.5	10	14.5	1
2.6	63	5.6	38	8.6	21	11.6	10	14.6	1
2.7	62	5.7	37	8.7	21	11.7	9	14.7	1
2.8	61	5.8	37	8.8	20	11.8	9	14.8	0
2.9	60	5.9	36	8.9	20	11.9	9	14.9	0
3.0	59	6.0	35	9.0	20	12.0	8	15.0	0

ATM 314 Expansive Breakdown of Stone on Soaking in Ethylene Glycol

1. Scope

This method covers a procedure for subjecting samples of stone to immersion in ethylene glycol and observation of the effects of such immersion in accordance with CRD-C 148-69.

2. Principle of Method

Ethylene glycol is one of the materials that reacts with swelling clays of the montmorillonite group to form an organo-clay complex having a larger basal spacing than that of the clay mineral itself. Hence a sample of stone containing swelling clay of the montmorillonite group will be expected to undergo expansive breakdown upon soaking in ethylene glycol, if the amount, distribution, state of expansion, and ability to take up glycol is such as to cause such breakdown to occur. If such breakdown does occur, it may be expected that similar breakdown may occur if similar rock samples are exposed, for longer times, to wetting and drying or freezing and thawing in a water soaked condition in service.

3. Reagent

Ethylene Glycol – The reagent used in this method shall be ethylene glycol meeting the requirements of ASTM D 2693.

4. Apparatus

- Jaw crusher with 150 mm (6 in) capacity.
- Sieves of the following sizes: 75 mm (3 in) and 19.0 mm (¾ in) and conforming to AASHTO M 92 (ASTM E11).
- Balance or scale: Capacity sufficient for the principle sample mass, readable to 0.1 percent or 0.1 g of the total sample mass and meeting the requirements of AASHTO M 231.
- Container shall be of suitable plastic, non-reactive with the reagent and of sufficient size to hold the test sample and sufficient reagent to cover all particles of the sample to a depth of not less than 10 mm (1/2 in) capped with a tight-fitting cover.

5. Sampling and Sample Preparation

1. Obtain representative samples of the stone in accordance with WAQTC FOP for AASHTO T 2 (ASTM D75).
2. Crush the rock to pass a 75 mm (3 in) sieve.
3. Separate the material into the required test size, using 75 mm (3 in) and 19 mm (¾ in) sieves, in accordance with WAQTC FOP for AASHTO T 27/T 11. Discard all particles retained on the 75 mm (3 in) sieve and all particles passing the 19 mm (¾ in) sieve, unless required for other testing.
4. Reduce the sample to a test size of 5 ± 2 kg (11 ± 1 lb) in accordance with WAQTC FOP for AASHTO T 248, Method A.
5. When a sample of the required mass and particle size has been prepared, it shall be washed to remove dust, loosely adherent coatings, and chips. After being washed, dry to a constant mass in accordance with WAQTC FOP for AASHTO T 255/T 265 except that constant mass shall be regarded as having been attained when the loss in weight between successive weighing at intervals of not less than 4 hours does

not exceed 0.1 percent. Determine the number of particles and the mass before immersion to the nearest 0.1 percent of the total sample mass.

6. Procedure

1. The sample shall be placed in the container and immersed in the reagent so that all particles are covered to a depth of at least 12.5 mm (½ in).
2. At intervals not to exceed 3 days, examine the sample and note significant changes. The normal duration of the test shall be 15 days.

Note 1: Further information of value may be obtained in certain cases by continuing the treatment beyond 15 days: in other cases expansive breakdown may have been too extensive at earlier periods that no information of value will be obtained by continuing the treatment for the full 15 days.

3. When the exposure has been terminated, the sample shall be thoroughly washed and sieved by hand over a 19 mm (¾ in) sieve to remove the reagent from the surfaces of the particles and to remove fragments that will pass a 19 mm (¾ in) sieve. The material remaining on the sieve shall be dried to constant weight as described in Step 4 of the Sampling and Sample Preparation, and the total mass after immersion determined to the nearest 0.1 percent of the total sample mass.

7. Calculations

Calculate the total percent loss by:

$$\% \text{ Loss} = \frac{M_B - M_A}{M_B} \times 100$$

Where:

M_B = Mass before immersion, and
 M_A = Mass after immersion.

8. Report

Report the percent loss to the nearest 1 percent on department forms.

ATM 315 Gradation Count of Riprap

1. Scope

Gradation count determines the distribution of particle masses within a given sample.

Apparatus

- Balance or scale: Accurate to 0.1 percent of the masses being determined and meeting the requirements of AASHTO M 231.
- Tape measure or rag tape.

2. Procedure (Method A)

1. Obtain a representative sample of the material, 5 CY minimum.
2. By hand, or with mechanical means, place each piece of Riprap on a scale.
3. Record mass on department approved form.
4. Determine the percentage of each weight range specified.

3. Procedure (Method B)

1. Obtain a representative sample of the material, 5 CY minimum.
2. Measure the longest dimension (length ft.) and two orthogonal dimensions (width, height ft.) of aggregate particles.
3. Record measurements on form.
4. Calculate mass by $L \text{ (ft.)} \times W \text{ (ft.)} \times H \text{ (ft.)} \times \text{Specific Gravity } (G_{sa}) \times 62.27 \left(\frac{\text{Lbs}}{\text{ft}^3}\right)$
5. Record mass on department approved form.
6. Determine the percentage of each mass range specified.

4. Calculations

$$\% \text{ of mass range} = \frac{\text{total mass within given range}}{\text{Total mass of sample}} \times 100$$

5. Report

- Results on forms approved by the Department.
- Individual mass of each particle.
- Percent of total mass in each category.
- Report percentages to the nearest 1 percent.

This page intentionally left blank.

ATM 316 Dustfall Column Test

1. Scope

This method describes the procedure for determining the *mean particle residence time* for dust falling in a dust column device. The purpose is to quantify the effectiveness of dust palliative on aggregate surface course.

This standard involves hazardous materials, operations and equipment. This standard does not purport to address all of the safety problems associated with its use. It is the responsibility of the agency to establish appropriate safety and health practices and to train the user of this standard prior to use. It is the responsibility of the user to consult the appropriate agency authority for and to practice and maintain the appropriate safety and health practices.

2. Apparatus

- Testing machine conforming to the design shown in Figure 1
- Sieves # 4 and # 8 conforming to AASHTO M 92 (ASTM E 11)
- Balance or scale: Class G1, sensitive to 0.01 g with a capacity sufficient for the principle sample mass, and meeting the requirements of AASHTO M 231
- Abrader with 80-grit sandpaper, and with ten-pound weight (for laboratory sample testing), and fifteen-pound weight (for field sample testing)
- Compaction mold and collar conforming to ATM 207 (AASHTO T 180), or CBR mold and collar
- Graduated pipet with metered pipet pump
- Cans/tins with covers, having a minimum volume of 100 ml and capable of holding 100 grams
- Containers made of material resistant to corrosion and impervious to moisture, having close-fitting lids to prevent loss of moisture from soil samples before compaction
- Miscellaneous tools, materials, and equipment including spatulas, putty knife, brushes, pan, parchment paper, laboratory grade acetone, torpedo level, low velocity anemometer, microfiber cloth, antistatic unscented dryer sheets, cleaning pig, antistatic spray, water bath, plastic beaker, Plexiglas column, intake tube, drop cone, *DustTrak II Aerosol Monitor 8530* or equivalent
- The day before dustfall testing, prepare about five gallons of water and store them overnight adjacent to the dustfall column device

3. Soil Sample Preparation

Method A (Field-Obtained or Laboratory-Prepared Aggregate Sample)

1. For field-obtained sample test, obtain field sample according to ATM 301. Go to Section 4 to continue test procedure
2. For laboratory-prepared sample test, perform ATM 207 (AASHTO T 180) on the soil/aggregate sample to determine optimum moisture content
3. Dry a separate soil/aggregate sample to constant mass in accordance with ATM 202
4. Sieve over #4 sieve and discard material retained on #4 sieve
5. Thoroughly mix the selected representative sample with sufficient water to dampen it to approximately 70% of optimum moisture content ($\pm 5\%$) as determined by ATM 207 (Step 2 above)

6. Place the prepared material in the mixing/storage dish, check its consistency (adjust if required), cover to prevent loss of moisture, and allow to saturate for at least 16 hours (overnight). After this standing period and immediately before starting the test, thoroughly remix the soil. Start the test within 36 hours of end of saturation period
 7. Compact the soil sample in 6-inch diameter Proctor or CBR mold in accordance with ATM 207
 8. Determine the quantity/volume of palliative to be applied using the following expression:
$$\text{Volume (ml)} = 82.58 \times \text{Field Application Rate (sq.yd./gallon)}$$
 , or
$$\text{Volume (ml)} = 743 \times \text{Field Application Rate (sq.ft./gallon)}$$
 9. Apply the quantity of palliative evenly over the surface of the compacted soil
- Note 1:* This may require multiple applications allowing the palliative to soak in between applications.
10. Allow to mature at room temperature in open air for fourteen days. If in a dusty environment cover with breathable cloth or move to dust-free environment. Go to Section 4 to continue test procedure.

Method B (Field-Abraded Sample)

1. Select locations on palliative treated section to obtain field abraded samples
2. Carefully sweep loose aggregate from the sample location using a soft brush
3. Place the abrader guide on the sample location
4. Load the abrader with 15-lbs weight and place the abrader in the circular hole in the abrader guide
5. Turn the abrader 10 full clockwise rotations without exerting downward pressure
6. Tilt the abrader on edge and carefully brush loose material off of the bottom of the abrader back into the abraded area
7. Using a soft brush and a putty knife, collect the abraded material from the abraded area and place the material into a moisture can
8. Replace the abrader into the hole in the abrader guide and repeat steps 5-7 until moisture can is approximately one-half full of sample
9. Repeat steps 1 through 9 (Method B) at other selected locations
10. Proceed to Section 4 (Soil Sample Abrasion), step 7

4. Soil Sample Abrasion

1. After fourteen days of maturation of the laboratory-prepared specimen, place the compaction collar on the mold
2. Cover a pan with parchment paper and place the mold in the pan
3. For laboratory-prepared specimen, load the abrader with a 10-lbs weight and place the abrader on top of the soil in the mold
4. For field-obtained sample, load the abrader with a 15-lbs weight and place the abrader on top of the sample
5. Apply ten full clockwise rotations of the abrader without exerting downward pressure
6. Clean the abraded soil surface and the sand paper using a regular 3-4 in. paint brush, avoiding breakdown and the loss of fines

Note 2: Use new sand paper for each tested specimen.

7. Gently sieve the abraded material over the #8 sieve over the parchment paper, taking care not to break down the soil and to prevent material to become airborne. Materials retained on the #8 sieve may be discarded
8. Repeat steps 5 and 6 until a minimum of 40 grams of material passing the #8 sieve have been collected. Limit rotations to twenty revolutions
9. Place the material passing the #8 sieve in a moisture can carefully to ensure the soil is not broken down
10. Seal the can with electric tape and label the can for content

5. Drop Cone Preparation

1. Clean the drop cone using a clean cloth dampened with acetone to remove any residual palliative
2. Using unscented dryer sheet or static-free cloth treated with antistatic spray, wipe the interior surfaces of the cone and the trap door
3. Close and latch the trap door

Note 3: Conduct the test within ten minutes.

6. Dust Column Preparation

1. Rotate the column into the horizontal position and remove the intake tube from the column
2. Clean the bottom of the column (which come into contact with water bath) with a damp sponge
3. Carefully clean the interior of the dust column with the cleaning pig covered with a clean microfiber cloth
4. Apply antistatic spray using the cleaning pig covered with a cloth treated with antistatic spray. Repeat this process one more time

Note 4: Perform antistatic spraying either in a different room than the test room or under a fume hood to prevent aerosol from impacting the test.

5. Install the intake tube facing downward into the column and tighten its bolts (do not over-tighten)

Note 5: Ensure that the intake tube is facing downward when the column is vertical.

6. Rotate the column back into the vertical position
7. Check verticality of column using the torpedo level
8. Using the water stored overnight next to the device, fill the water bath at the bottom of the column to a depth of approximately 3.5 inches

Note 6: Refer to the last bullet of Section 2. Addition of a small amount of soap in the water may break up the surface tension on the water and soften the dust rebound.

9. Lower the bottom of the column into the water approximately 1 inch
10. Place the *DustTrak* device on a pedestal facing the intake tube and attach it to the intake tube using the rubber hose

Note 7: Ensure rubber hose is almost horizontal. Note that the hose length is not critical.

7. Procedure

1. Carefully open the moisture can (Step 8 in Section 4) and gently mix the sample to achieve a uniform sample
2. Quarter the sample by scoring two orthogonal lines through the sample
3. Place an empty weighing tin on the balance and tare it. Weigh 5 grams of sample (+/- 0.05 g) taking small portions from each quarter until the required 5 grams have been collected
4. Carefully place the sample in the drop cone avoiding contact with the sides of the cone
5. Place the cone on the column and cover with a plastic beaker
6. Ensure that the cone is aligned with the column index marks
7. Zero the *DustTrak* using the procedure outlined in its manual and let it run for one minute

Note 8: Review the *DustTrak* manual for operating instructions.

8. Set the sample interval to 1 second on the *DustTrak*
9. Set the testing time using these guidelines:
 - a. 4 minutes for a treated sample expected to work well
 - b. 7 minutes for a sample that is anticipated to have marginal performance
 - c. 20 minutes for an untreated sample

Note 9: It is recommended to program longer time if in doubt and stop the test once background has been reached.

10. Start the *DustTrak* and allow it to run for one minute to obtain a background level. This will be used in the analysis and included in the test report

Note 10: Do not stop the *DustTrak* before tripping the trap door. If the background level exceeds 0.010 mg/m³ either use a dust filter in the room or move to a space which has a background level below 0.010 mg/m³.

11. Trip the trap door after approximately one minute
12. Allow the test to run until background level value is reached
13. Download the data onto a flash drive to transfer to a computer for analysis

8. Calculations and Data Analysis

1. Import the test data into a spreadsheet
2. Plot *time (sec)* on the horizontal axis and the natural log of *concentration (mg/m³)* on the vertical axis
3. Print the graph. Figure 2 shows a typical graph
4. Starting at the left of the graph (i.e. at the maximum concentration value, typically 1 to 2 seconds after dropping the sample), draw a best-fit line through the initial linear portion of the graph until there is a break in linearity. This portion of the data represents the rebound phase of the test
5. Starting at the right, draw a best-fit line through the data points that comprise the phase following the initial linear portion of the data set. This portion of the data represents the dustfall phase (if it exists)
6. Find the intersection of the two lines and select the time coordinate closest to the intersection. Note this value

7. Determine the slope of the rebound phase portion of the graph. The linear regression command in the spreadsheet can be used to determine this slope. Note the slope of this best-fit (slopeR)
8. Determine the slope of the dustfall phase portion of the graph. The linear regression command in the spreadsheet can be used to determine this slope. Note the slope of this best-fit (slopeD)
9. Calculate the *mean particle residence time* (T, sec) for the rebound phase as follows: $T = 1 / \text{slopeR}$

Note 11: Alternatively the test data can be imported into the online analysis tool Dust Palliative Calculator found at <http://autc.uaf.edu/engineering-tools/>. Follow the instructions provided.

9. Report

Report the following:

1. The type, source, description and classification of the soil tested
2. The type, name, source and concentration of the palliative used, if any
3. The *DustTrak* background level before starting the test
4. The coordinates of the intersection of the two lines (Step 6 in Section 8), to the nearest 0.1
5. The slopes of each line (Steps 7 and 8 in Section 8) to the nearest 0.01
6. The *mean particle residence time* (Step 9 in Section 8), to the nearest 0.1

Note 12: Alternatively print out the test results page of the online analysis tool, if used.

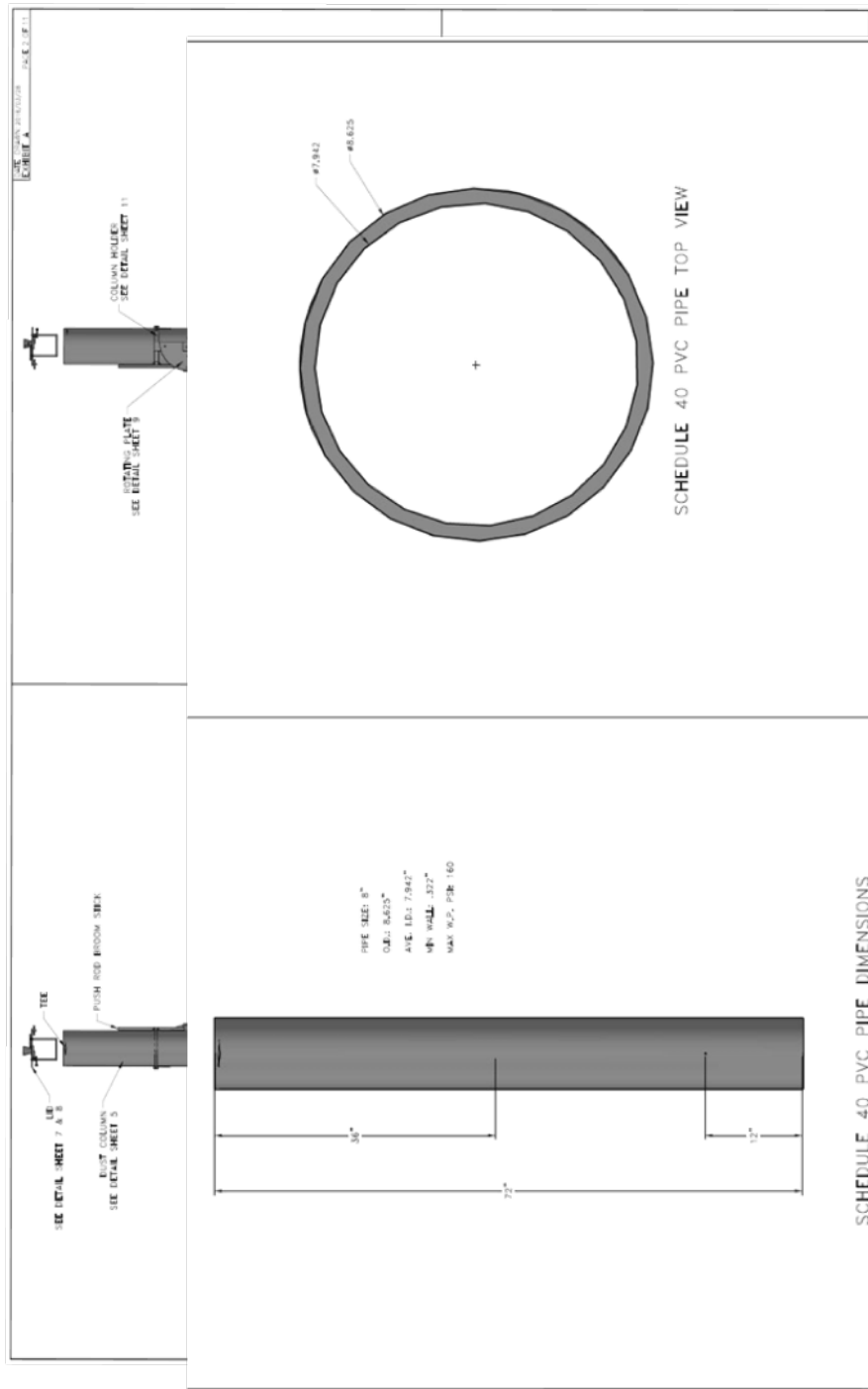

Figure 1
Drawings of the Testing Device.
 (All Dimensions in Inches)

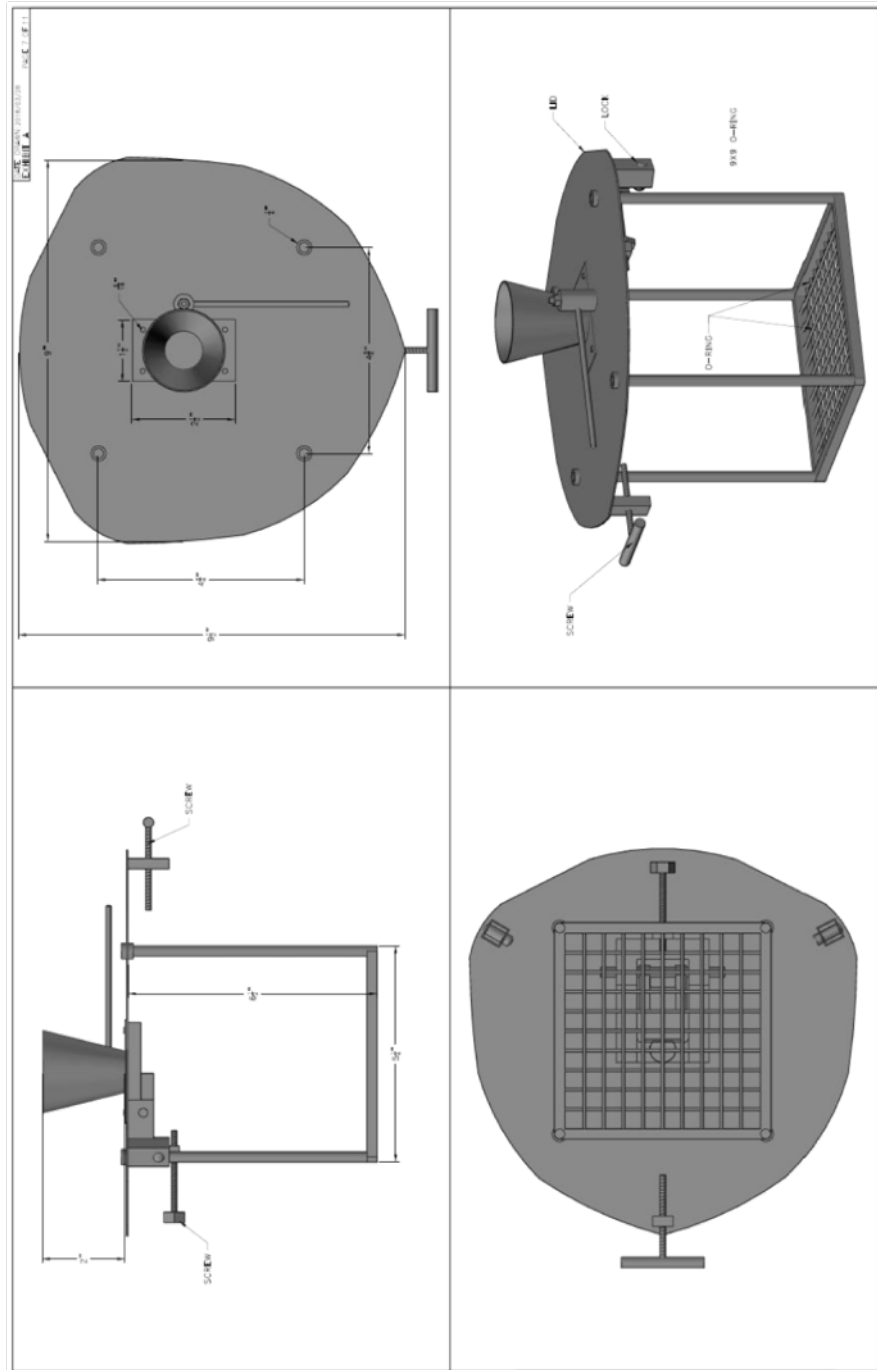

Figure 1
Drawings of the Testing Device
 (All Dimensions in Inches)

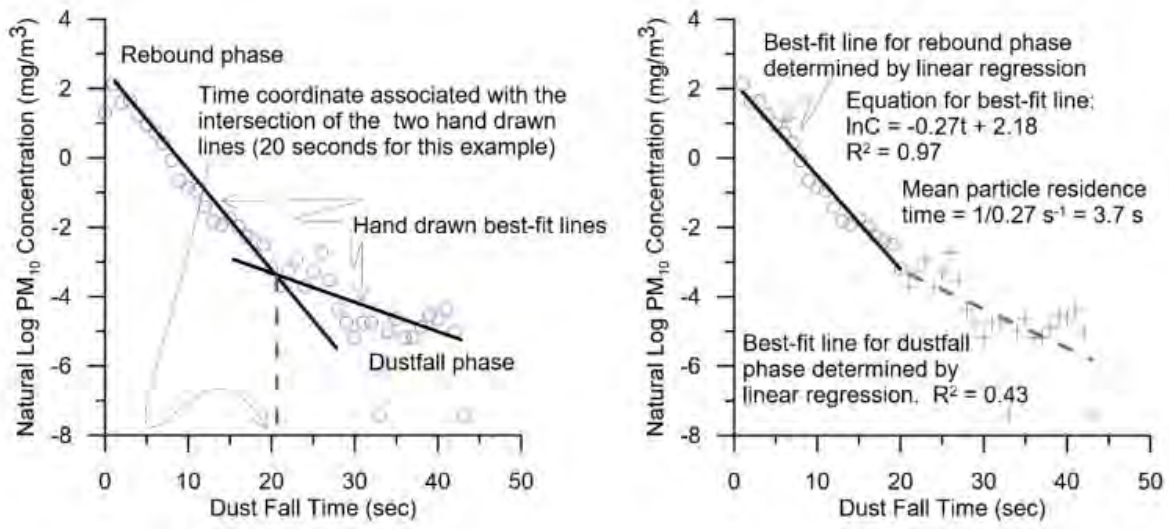

Figure 2
Typical Test Data and Calculation of Mean Particle Residence Time

ATM 317 Resistance of Coarse Aggregate to Degradation by Abrasion in the Micro-Deval Apparatus

Following are guidelines for use of ATM FOP for AASHTO T 327 by State of Alaska DOT&PF

Obtain a sample in accordance with *ATM 301* - WAQTC FOP for AASHTO R 90 Sampling Aggregate Products.

Reduce sample to testing size in accordance with *ATM 303* - WAQTC FOP for AASHTO R 76 Reducing Samples of Aggregate to Testing Size.

1. Test sample shall be washed and oven-dried at no less than $110 \pm 5^{\circ}$ C to constant mass.
2. Sample shall be separated into individual size fractions in accordance with *ATM 304* - WAQTC FOP for AASHTO T 27/T 11 Sieve Analysis of Fine and Coarse Aggregates. Recombined to meet the appropriate grading in Table 1, 2, or 3 of AASHTO T 327, based on the nominal maximum aggregate size of the embankment, paving, or surfacing layer wherein the aggregate is incorporated.
3. Record initial dry mass of sample to the nearest 1.0 g.
4. Sample shall be immersed in 2.0 liters of tap water at $20 \pm 5^{\circ}$ C for minimum of 1 hour then placed with the water into the Micro Deval abrasion container with 5000 ± 5 g of steel balls. Attach cover securely and place container on the machine.
5. Run the machine at the appropriate rate for the specified number of revolutions for the grading tested.
6. At the end of the test period carefully pour the sample and steel balls over a 4.75 mm sieve nested on top of a 1.18 mm sieve and wash until all of the material finer than 1.18 mm has been washed away. Remove the steel balls. Combine the material retained on the two nested sieves and dry to constant mass. Record final mass to nearest 1.0 g.
7. Report percent loss to the nearest 0.1 percent.

This page intentionally left blank.

STANDARD METHOD OF TEST FOR RESISTANCE OF COARSE AGGREGATE TO DEGRADATION BY ABRASION IN THE MICRO-DEVAL APPARATUS FOP FOR AASHTO T 327

Scope

This procedure covers the determination of resistance to abrasion of coarse aggregate in the Micro Deval Apparatus in accordance with AASHTO T 327.

The test shall be performed on the specific size aggregate fractions.

The test is applicable to crushed and uncrushed natural and artificial aggregates.

Footnotes or notes within the text of this method provide explanatory information. These footnotes and notes (excluding those found in tables or figures) shall not be considered requirements of the test method.

This test method involves potentially hazardous materials, operations and equipment. This method does not purport to address all of the safety problems associated with its use. It is the responsibility of the user of this method to establish appropriate safety and health practices and to determine the applicability of regulatory limitation prior to its use.

Referenced Documents

AASHTO Standards

- M 231, Weighing Devices used in The Testing of Materials
- T 27, Sieve Analysis of Fine and Coarse Aggregates

ASTM Standards

- C670, Standard Practice for Preparing Precision and Bias Statements for Test Methods for Construction Materials
- E11, Standard Specification for Woven Wire Test Sieve Cloth and Test Sieves

ATMM Standards

- ATM 301 WAQTC FOP for AASHTO R 90 Sampling Aggregate Products
- ATM 303 - WAQTC FOP for AASHTO R 76 Reducing Samples of Aggregate to Testing Size.
- ATM 304 WAQTC FOP for AASHTO T 27/T 11 Sieve Analysis of Fine and Coarse Aggregates

Summary of Test Method

The Micro-Deval test measures the abrasion resistance and durability of mineral aggregates resulting from the abrasion and grinding in the presence of steel balls and water. A standard graded sample is initially soaked in water for not less than 1 hour. The sample is placed in a steel jar mill with 2.0 L of water and a charge of 5000 g of 9.5mm diameter steel balls and revolved at 100 rpm for 2 hours, based on particle size. The sample is washed and oven dried. Loss is the percent by mass of the original sample passing the 1.18 mm sieve.

Apparatus

- *Micro-Deval Abrasion Machine*—A jar rolling mill capable of running at 100 ± 5 rpm.
Note 1—Micro-Deval abrasion machine fitted with a counter may be used if the test is conducted on the basis of number of revolutions.
- *Container*—Stainless steel Micro-Deval abrasion jars having a 5-L capacity with a rubber ring in the rotary locking cover; an external diameter of 194 to 202 mm, and an internal height of 170 to 177 mm. The inside and outside surfaces of the jars shall be smooth and have no observable ridges or indentations.

- *Abrasion Charge* – 5000 ±5 g of magnetic steel balls having a diameter of 9.5 ±0.5 mm for each jar.
- *Sieves* – Sieves with square openings of 19.0 mm, 16.0 mm, 12.5 mm, 9.5 mm, 6.3 mm, 4.75 mm, 1.18 mm, conforming to *ASTM E11*.
- *Oven* – capable of maintaining a temperature of at least 110 ± 5° C.
- *Balance* – Balance or scale accurate to 1.0 g and conforming to AASHTO M 231.
- *Magnet (optional)* – for removal of the steel ball charge from the test specimen after abrasion.

Sampling

Obtain a sample in accordance with *ATM 301* - WAQTC FOP for AASHTO R 90 Sampling Aggregate Products.

Test Sample

- Test sample shall be washed and oven-dried at no less than 110 ± 5°C to constant mass, separated into individual size fractions in accordance with ATM 304, and recombined to meet the appropriate grading below.
- Test Aggregate shall normally consist of 1500 ± 5g oven-dried material passing the 19.0 mm sieve and retained on the 9.5 mm sieve per Table 1.

Table 1
Preparation of an Oven-Dried Sample of 19.0 mm

Passing	Retained	Mass
19.0 mm	16.0 mm	375 g
16.0 mm	12.5 mm	375 g
12.5 mm	9.5 mm	750 g

- If the nominal maximum size of coarse aggregate is 12.5 mm or less, a sample of 1500 ± 5 g shall be prepared per Table 2.

Table 2
Preparation of an Oven-Dried Sample of Less Than 16.0 mm

Passing	Retained	Mass
12.5 mm	9.5 mm	750 g
9.5 mm	6.3 mm	375 g
6.3 mm	4.75 mm	375 g

- If the nominal maximum size of coarse aggregate is 9.5 mm or less, a sample of 1500 ± 5 g shall be prepared per Table 3.

Table 3
Preparing an Oven-Dried Sample of Less Than 12.5 mm

Passing	Retained	Mass
9.5 mm	6.3 mm	750 g
6.3 mm	4.75mm	750 g

Test Procedure

1. Prepare the appropriate 1500 ±5 g test sample. Determine mass “A” and record to the nearest 1.0 g.
2. Immerse the sample in 2.0 ± 0.05 L of tap water at a temperature of 20 ± 5 °C for a minimum of 1 hour in either the Micro-Deval container or a suitable container.

3. Place the test sample and water in the Micro-Deval abrasion container with 5000 ± 5 g of magnetic steel balls. Install the cover and place the container on the machine.
4. Run the machine at 100 ± 5 rpm for $12,000 \pm 100$ revolutions for the grading shown in Table 1; for $10,500 \pm 100$ revolutions for the grading shown in Table 2; and for 9500 ± 100 revolutions for the grading shown in Table 3.
 - a. **Note 2**—If the test machine is not capable of measuring the total number of revolutions of the drum, time may be used as follows:
 - b. Run the machine at 100 ± 5 rpm for 120 ± 1 min for the grading shown in Table 1. For the grading shown in Table 2, run the machine for 105 ± 1 min. For the grading shown in Table 3, run the machine for 95 ± 1 min.
5. Carefully pour the entire sample and steel balls over a 4.75-mm sieve nested on a 1.18-mm sieve. Confirm that the entire sample has been removed from the stainless steel jar. Using a hand-held water hose, wash and manipulate the retained material on the sieve until the washings are clear. Assure all material smaller than 1.18 mm passes that sieve. Remove the stainless steel balls using a magnet or other suitable means. Discard any material smaller than 1.18 mm.
6. Combine the material retained on the 4.75-mm and 1.18-mm sieves. Be careful not to lose any material.
7. Oven-dry the sample to constant mass at 110 ± 5 °C.
8. Weigh the sample to the nearest 1.0 g and record the mass as “B.”

Calculation and Expression of Results

Calculate the Micro-Deval abrasion loss, as follows, to the nearest 0.1 percent:

$$\text{Percent Loss} = 100 (A - B)/A$$

Where:

A = mass, as determined in **Test Procedure**

B = mass, as determined in **Test Procedure**

Report

Micro Deval percentage of loss shall be reported on Department forms to the nearest 0.1 percent.

APPENDIX A

Reference Aggregate—The laboratory will establish an adequate supply of material to use for monitoring testing consistency through the establishment of control limits. A suitable material with an average loss of between 15 and 25 percent shall be established. From this material, 10 samples shall be taken randomly and tested. At any time a new supply is required, this procedure shall be conducted on a new supply.

To determine the mean loss and sample standard deviation of the reference aggregate see Section 11 of AASHTO T 327.

For continued acceptance of data, individual reference aggregate test data must fall within the range of ± 2 standard deviations of the mean percent loss 95 percent of the time. When test data from the reference aggregate is outside the limits, an investigation as to the probable cause shall be conducted. The equipment shall be checked and the testing technique re-examined to detect nonconformance with the test procedure.

Every 10 samples, but at least every week in which a sample is tested, a sample of the reference aggregate shall be tested. The material shall be taken from a stock supply and prepared according to Section 8. When 20 samples of reference aggregate have been tested, and the results show satisfactory variation, the frequency of testing may be changed to a minimum of one sample every month.

Trend Chart Use — The percent loss of the last 20 samples of reference aggregate shall be plotted on a trend chart in order to monitor the variation in results (see Figure 2). The Upper and Lower Range Limits are defined as ± 2 standard deviations of the mean percent loss established from AASHTO T327 Section 11.1.1.

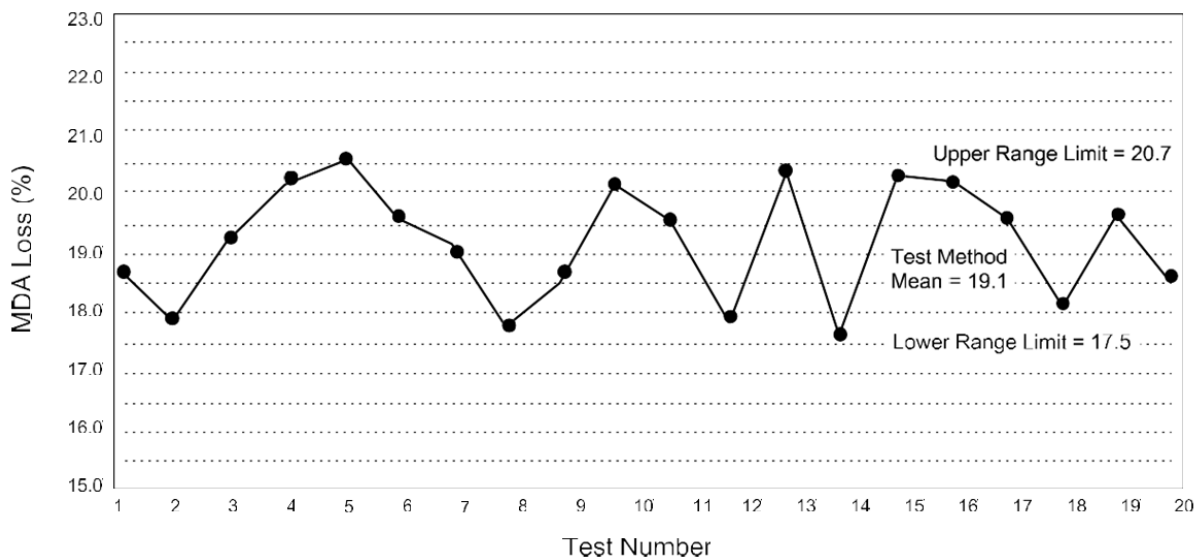

Figure 1
Micro-Deval Abrasion Trend Chart for Reference Aggregate Samples

Asphalt Worksheet - ATM 317 Micro-Deval Degradation

Project Name:		Sample Number:
Federal No:	AKSAS No.	
Material:	Source:	
Item No:	Location:	
Test Location:	Sampled by:	Date Sampled:
Depth:	Testing Tech:	Date Received:
C/L & Grade Reference:	Quantity Represented:	Lab Number:

Resistance of Coarse Aggregate to Degradation by Abrasion in the Micro-Deval Apparatus AASHTO T 327 (ASTM D6928)

Test Sample

1. Obtain a sample in accordance with ATM 301 - WAQTC FOP for AASHTO R 90 Sampling Aggregate Products.
2. Reduce sample to testing size in accordance with ATM 303 - WAQTC FOP for AASHTO R 76 Reducing Samples of Aggregate to Testing Size.
3. Test sample shall be washed and oven-dried at no less than $110 \pm 5^{\circ}\text{C}$ ($230 \pm 9^{\circ}\text{F}$) to constant mass.

Procedure

4. Sample shall be separated into individual size fractions in accordance with ATM 304 - WAQTC FOP for AASHTO T 27/T 11 Sieve Analysis of Fine and Coarse Aggregates. Recombined to meet the appropriate grading in Table 1, 2, or 3 of AASHTO T 327, based on the nominal maximum aggregate size of the embankment, paving, or surfacing layer wherein the aggregate is incorporated.
5. Record initial dry mass of sample to the nearest 1.0 g.
6. Sample shall be immersed in 2.0 liters of potable water at $20 \pm 5^{\circ}\text{C}$ ($68 \pm 9^{\circ}\text{F}$) for minimum of 1 hour then placed with the water into the Micro Deval abrasion container with 5000 ± 5 g of steel balls. Attach cover securely and place container on the machine.
7. Run the machine at the appropriate rate for the specified number of revolutions for the grading tested.
8. At the end of the test period carefully pour the sample and steel balls over a 4.75 mm sieve nested on top of a 1.18 mm sieve and wash until all of the material finer than 1.18 mm has been washed away. Remove the steel balls.
- Combine the material retained on the two nested sieves and dry to constant mass. Record final mass to nearest 1.0 g.
9. Report percent loss to the nearest 0.1 percent.

Table 1		Sample: 19.0 to 9.5mm	12,000 ± 100 Revolutions	Total Initial Mass Required = 1500 ± 5g		
Passing (mm)	Retained (mm)	Mass (g)	Initial mass			
19.0	16.0	375				
16.0	12.5	375				
12.5	9.5	750		Final mass	Mass loss	% Loss
		Total =				
Table 2		Sample: 12.5 to 4.75mm	10,500 ± 100 Revolutions	Total Initial Mass Required = 1500 ± 5g		
Passing (mm)	Retained (mm)	Mass (g)	Initial mass			
12.5	9.5	750				
9.5	6.3	375				
6.3	4.75	375		Final mass	Mass loss	% Loss
		Total =				
Table 3		Sample: 9.5 to 4.75mm	9,500 ± 100 Revolutions	Total Initial Mass Required = 1500 ± 5g		
Passing (mm)	Retained (mm)	Mass (g)	Initial mass			
9.5	6.3	750				
6.3	4.75	750		Final mass	Mass loss	% Loss
		Total =				

Data entry cell indicated with light blue shading

Asphalt Worksheet - ATM 317 Micro-Deval Degradation

Project Name:		Sample Number:
Federal No:	AKSAS No.	
Material:	Source:	
Item No:	Location:	
Test Location:	Sampled by:	Date Sampled:
Depth:	Testing Tech:	Date Received:
C_L & Grade Reference:	Quantity Represented:	Lab Number:

Resistance of Coarse Aggregate to Degradation by Abrasion in the Micro-Deval Apparatus AASHTO T 327 (ASTM D6928)

Test Sample

1. Obtain a sample in accordance with ATM 301 - WAQTC FOP for AASHTO R 90 Sampling Aggregate Products.
2. Reduce sample to testing size in accordance with ATM 303 - WAQTC FOP for AASHTO R 76 Reducing Samples of Aggregate to Testing Size.
3. Test sample shall be washed and oven-dried at no less than $110 \pm 5^{\circ}\text{C}$ ($230 \pm 9^{\circ}\text{F}$) to constant mass.

Procedure

4. Sample shall be separated into individual size fractions in accordance with ATM 304 - WAQTC FOP for AASHTO T 27/T 11 Sieve Analysis of Fine and Coarse Aggregates. Recombined to meet the appropriate grading in Table 1, 2, or 3 of AASHTO T 327, based on the nominal maximum aggregate size of the embankment, paving, or surfacing layer wherein the aggregate is incorporated.
5. Record initial dry mass of sample to the nearest 1.0 g.
6. Sample shall be immersed in 2.0 liters of potable water at $20 \pm 5^{\circ}\text{C}$ ($68 \pm 9^{\circ}\text{F}$) for minimum of 1 hour then placed with the water into the Micro Deval abrasion container with 5000 ± 5 g of steel balls. Attach cover securely and place container on the machine.
7. Run the machine at the appropriate rate for the specified number of revolutions for the grading tested.
8. At the end of the test period carefully pour the sample and steel balls over a 4.75 mm sieve nested on top of a 1.18 mm sieve and wash until all of the material finer than 1.18 mm has been washed away. Remove the steel balls.
- Combine the material retained on the two nested sieves and dry to constant mass. Record final mass to nearest 1.0 g.
9. Report percent loss to the nearest 0.1 percent.

Table 1	Sample: 19.0 to 9.5mm	12,000 ± 100 Revolutions	Total Initial Mass Required = 1500 ± 5g			
Passing (mm)	Retained (mm)	Mass (g)	Initial mass			
19.0	16.0	375	375			
16.0	12.5	375	375.8			
12.5	9.5	750	750.2	Final mass	Mass loss	% Loss
		Total =	1501.0	1325.7	175.3	11.7%
Table 2	Sample: 12.5 to 4.75mm	10,500 ± 100 Revolutions	Total Initial Mass Required = 1500 ± 5g			
Passing (mm)	Retained (mm)	Mass (g)	Initial mass			
12.5	9.5	750	750			
9.5	6.3	375	375			
6.3	4.75	375	373.1	Final mass	Mass loss	% Loss
		Total =	1498.1	1467.3	30.8	2.1%
Table 3	Sample: 9.5 to 4.75mm	9,500 ± 100 Revolutions	Total Initial Mass Required = 1500 ± 5g			
Passing (mm)	Retained (mm)	Mass (g)	Initial mass			
9.5	6.3	750	749.6			
6.3	4.75	750	750.2	Final mass	Mass loss	% Loss
		Total =	1499.8	1225.9	273.9	18.3%

Data entry cell indicated with light blue shading

(For electronic copy, contact richard.giesel@alaska.gov)

ATM 401 Sampling Asphalt Materials

The following guidelines for the use of WAQTC FOP for AASHTO R 66 by the State of Alaska DOT&PF.

1. When obtaining samples from HMA plants, sample only from the line between the storage tank and the mixing plant while the plant is in operation.
2. Sample containers for elastomer modified asphaltic cements shall conform to requirements under containers/asphalt binders.
3. When sampling emulsified asphalt, use 1 gallon wide mouth plastic containers.
4. When material is sampled by other than DOT&PF personnel or their agent(s), the sampling must be witnessed and possession of the sample transferred immediately to DOT&PF personnel or their agent(s).
5. Sampling locations are described in AASHTO R 66. They include the spigot at HMA plant, from barrels, from the delivery truck or the distributor spray bar.

This page intentionally left blank.

SAMPLING ASPHALT MATERIALS FOP FOR AASHTO R 66

Scope

This procedure covers obtaining samples of liquid asphalt materials in accordance with AASHTO R 66-16. Sampling of solid and semi-solid asphalt materials – included in AASHTO R 66 – is not covered here.

Agencies may be more specific on exactly who samples, where to sample, and what type of sampling device to use.

Warning: Always use appropriate safety equipment and precautions for hot liquids.

Terminology

- Asphalt binder: Asphalt cement or modified asphalt cement that binds the aggregate particles into a dense mass.
- Asphalt emulsion: A mixture of asphalt binder and water.
- Cutback asphalt: Asphalt binder that has been modified by blending with a chemical solvent.

Containers

Sample containers must be new, and the inside may not be washed or rinsed. The outside may be wiped with a clean, dry cloth.

All samples shall be put in 1 L (1 qt) containers and properly identified on the outside of the container with contract number, date sampled, data sheet number, brand and grade of material, and sample number. Include lot and subplot numbers when appropriate.

- Emulsified asphalt: Use wide-mouth plastic jars with screw caps. Protect the samples from freezing since water is a part of the emulsion. The sample container should be completely filled to minimize a skin formation on the sample.
- Asphalt binder and cutbacks: Use metal cans

Note: The sample container shall not be submerged in solvent, nor shall it be wiped with a solvent saturated cloth. If cleaning is necessary, use a clean dry cloth.

Procedure

1. Coordinate sampling with contractor or supplier.
2. Allow a minimum of 4 L (1 gal) to flow before obtaining samples.
3. Obtain samples of:
 - Asphalt binder from the line between the storage tank and the mixing plant while the plant is in operation, or from the delivery truck.
 - Cutback and emulsified asphalt from distributor spray bar or application device; or from the delivery truck before it is pumped into the distributor. Sample emulsified asphalt at delivery or before dilution.

Report

- On standard agency forms
- Sample ID
- Date
- Time
- Location
- Quantity represented

ATM 402 Sampling of Asphalt Mixtures

Following are guidelines for the use of WAQTC FOP for AASHTO R 97 (derived from ASTM D979) by the State of Alaska DOT&PF.

1. ATM 403 contains additional sampling methods.
2. When sampling asphalt mixture from a mat after compaction, sample in accordance with ATM 413 “Standard Practice for Sampling Asphalt Mixtures after Compaction (Obtaining Cores).”
3. Remove **Procedure –Windrow** step 3 and replace with:
“Remove and discard the top 12 inches of material or half the depth of the windrow, whichever is less, from each section.”
4. Change every instance of “Combine the increments to form a single sample” in the last step of any sampling method to “Combine and mix the increments to for a sample of the required size.”

This page intentionally left blank.

SAMPLING OF ASPHALT MIXTURES

FOP FOR AASHTO R 97

Scope

This procedure covers sampling asphalt mixtures from plants, haul units, and roadways in accordance with AASHTO R 97-19. Sampling is as important as testing. Use care to obtain a representative sample. Avoid segregation and contamination of the material during sampling.

This standard does not purport to address all of the safety concerns, if any, associated with its use. It is the responsibility of the user of this standard to establish appropriate safety and health practices and determine the applicability of regulatory limitations prior to use.

Apparatus

- Shovel or Metal Scoops, or Other Equipment: square-head metal shovels at least 125 mm (5.5 in.) wide.
- Sample containers: such as cardboard boxes, metal cans, stainless steel bowls, or other agency-approved containers
- Sampling plate: thick metal plate, minimum 8 gauge, sized to accommodate sample requirements, with a wire attached to one corner long enough to reach from the center of the paver to the outside of the farthest auger extension. A minimum of one hole 6 mm (0.25 in.) in diameter must be provided in a corner of the plate.
- Cookie cutter sampling device: formed steel angle with two 100 mm by 150 mm by 9 mm (4 in. by 6 in. by 3/8 in.) handles, sized to accommodate sample requirements. Minimum 50 mm (2 in.) smaller than the sampling plate when used together.

Example: Sampling plate 380 mm (15 in.) square and a cookie cutter sampling device 330 mm (13 in.) square.

- Mechanical sampling device: a permanently attached device that allows a sample receptacle to pass perpendicularly through the entire stream of material or diverts the entire stream of material into the container by manual, hydraulic, or pneumatic operation.
- Release agent: a non-stick product that prevents the asphalt mixture from sticking to the apparatus and does not contain solvents or petroleum-based products that could affect asphalt binder properties.

Sample Size

Sample size depends on the test methods specified by the agency for acceptance. Check agency requirement for the size required.

Procedure

General

- Select sample locations using a random or stratified random sampling procedure, as specified by the agency. The material shall be tested to determine variations. The supplier/contractor shall provide equipment for safe and appropriate sampling, including sampling devices on plants when required.
- Ensure the container(s) and sampling equipment are clean and dry before sampling.
- For dense graded mixture samples use cardboard boxes, stainless steel bowls or other agency-approved containers.

- For hot open graded mixture samples use stainless steel bowls. Do not put open graded mixture samples in boxes until they have cooled to the point that asphalt binder will not migrate from the aggregate.

Attached Sampling Devices

These are normally permanently attached devices that allow a sample container to pass perpendicularly through the entire stream of material. Operation may be manual, pneumatic, or hydraulic and allow the sample container to pass through the stream twice, once in each direction, without overfilling. A sampling device may also divert the entire stream into container.

- Lightly coat the container attached to the sampling device with an agency-approved release agent or preheat it, or both, to approximately the same discharge temperature of the mix.
- Pass the container twice, once in each direction, through the material perpendicularly without overfilling the container.
- Transfer the asphalt mixture to an agency-approved container without loss of material.
- Repeat until proper sample size has been obtained.
- Combine the increments to form a single sample.

Conveyor Belts

- Avoid sampling at the beginning or end of an asphalt mixture production run due to the potential for segregation.
- Stop the belt containing asphalt mixture.
- Set the sampling template into the asphalt mixture on the belt, avoiding intrusion by adjacent material.
- Remove the asphalt mixture from inside the template, including all fines, and place in a sample container.
- Repeat, obtaining equal size increments, until proper sample size has been obtained.
- Combine the increments to form a single sample.

Haul Units

- Visually divide the haul unit into approximately four equal quadrants.
- Identify one sampling location in each quadrant.
- Dig down and remove approximately 0.3 m (1 ft.) of material to avoid surface segregation. Obtain each increment from below this level.
- Combine the increments to form a sample of the required size.

Paver Auger

- Obtain samples from the end of the auger using a square head shovel.
- Place the shovel in front of the auger extension, with the shovel blade flat upon the surface to be paved over.
- Allow the front face of the auger stream to cover the shovel with asphalt mixture, remove the shovel before the auger reaches it by lifting as vertically as possible.
- Place asphalt mixture in a sample container.

- Repeat until proper sample size has been obtained.
- Combine the increments to form a sample of the required size.

Note 1: First full shovel of material may be discarded to preheat and ‘butter’ the shovel.

Windrow

- Obtain samples from the windrow of a transport unit. Avoid the beginning or the end of the windrow section.
- Visually divide the windrow into approximately three equal sections.
- Remove approximately 0.3 m (1 ft) from the top of each section.
- Fully insert the shovel into the flat surface as vertically as possible, exclude the underlying material, roll back the shovel and lift the material slowly out of the windrow to avoid material rolling off the shovel.
- Place in a sample container.
- Repeat, obtaining equal size increments, in each of the remaining thirds.
- Combine the increments to form a sample of the required size.

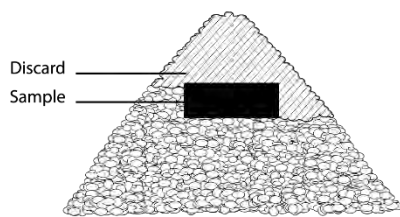

Windrow cross section

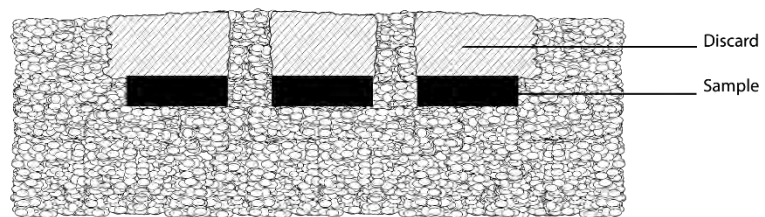

Windrow side view

Roadway before Compaction

There are two conditions that will be encountered when sampling asphalt mixtures from the roadway before compaction. The two conditions are:

- Laying asphalt mixture on grade or untreated base material requires Method 1.
- Laying asphalt mixture on existing asphalt or laying a second lift of asphalt mixture requires Method 2.

SAFETY:

Sampling is performed behind the paving machine and in front of the breakdown roller. For safety, the roller must remain at least 3 m (10 ft.) behind the sampling operation until the sample has been **obtained** and the hole filled with loose asphalt mixture.

Method 1 requires a plate to be placed in the roadway in front of the paving **operation**. **There** is always concern with moving, operating equipment. It is safest to stop the paving train while a plate is installed in front of the paver. When this is not possible the following safety rules must be followed.

- The plate placing operation must be at least 3 m (10 ft.) in front of the paver or pickup device. The technician placing the plate must have eye contact and communication with the paving machine operator. If eye contact cannot be maintained at **all times**, a third person must be present to provide communication between the operator and the technician.

- No technician is to be between the asphalt supply trucks and the paving machine. The exception to this rule is if the supply truck is moving forward creating a windrow, in which case the technician must be at least 3 m (10 ft.) behind the truck.

If at any time the Engineer feels that the sampling technique is creating an unsafe condition, the operation is to be halted until it is made **safe, or** the paving operation will be stopped while the plate is being placed.

Method 1 - Obtaining a Sample on Grade or Untreated Base (Plate Method)

- Following the safety rules detailed above, the technician is to:
 - Smooth out a location in front of the paver at least 0.5 m (2 ft.) inside the edge of the mat.
 - Lay the plate down diagonally with the direction of travel, keeping it flat and tight to the base with the lead corner facing the paving machine.
- Note 2:* The plate may be secured by driving a nail through the hole in the lead corner of the plate.
- Pull the wire, attached to the outside corner of the plate, taut past the edge of the asphalt mixture mat and secure it. Let the paving operation pass over the plate and wire.
 - Using the exposed end of the wire, pull the wire up through the fresh asphalt mixture to locate the corner of the plate.
 - Plate only:
 - Using a small square head shovel, scoop, or both, remove the full depth of the asphalt mixture from the plate. Take care to prevent sloughing of adjacent material.
 - Place asphalt mixture, including any material adhering to the plate and scoop or shovel in a sample container.
 - **Remove the plate from the roadway. The hole made from the sampling must be filled by the contractor with loose asphalt mixture.**
 - “Cookie Cutter”:
 - Place the “cookie cutter” sample device, just inside the end of the wire; align the cutter over the plate. Press “cookie cutter” device down through the asphalt mixture to the plate.
 - Using a small square tipped shovel or scoop, or both, carefully remove all the asphalt mixture from inside of the cutter and place in a sample container.
 - Remove the sample cutter and the plate from the roadway. The hole made from the sampling must be filled by the contractor with loose asphalt mixture.

Method 2 - Obtaining a Sample on Asphalt Surface (Non-plate Method)

- After the paving machine has passed the sampling point, immediately place the “cookie cutter” sampling device on the location to be sampled.
- Push the cutter down through the asphalt mixture until it is flat against the underlying asphalt mat.
- Using a small square tipped shovel, scoop, or both, carefully remove all the asphalt mixture from inside of the cutter and place in a sample container.
- Remove the cutter from the roadway. The hole made from the sampling must be filled by the contractor with loose asphalt mixture.

Stockpiles

Remove at least 0.1 m (4 in.) from the surface before sampling; mixtures in a stockpile may develop an oxidized crust.

Method 1 – Loader

- Direct the loader operator to enter the stockpile with the bucket at least 0.3 m (1 ft) above ground level without contaminating the stockpile.
- Obtain a full loader bucket of the asphalt mixture; tilt the bucket back and up.
- Form a small sampling pile at the base of the stockpile by gently rolling the asphalt mixture out of the bucket with the bucket just high enough to permit free flow of the mixture. Repeat as necessary.
- Create a flat surface by having the loader "back-drag" the small pile.
- Obtain approximately equal increments from at least three randomly selected locations on the flat surface at least 0.3 m (1 ft) from the edge.
- Fully insert the shovel, exclude the underlying material, roll back the shovel and lift the asphalt mixture slowly out of the pile to avoid mixture rolling off the shovel.
- Combine the increments to form a sample.

Method 2 – Stockpile Face

- Create horizontal surfaces with vertical faces in the top, middle, and bottom third of the stockpile with a shovel or a loader if one is available.
- Shove a flat board against the vertical face behind the sampling location to prevent sloughing of asphalt mixture. Discard the sloughed mixture to create the horizontal surface.
- Obtain the sample from the horizontal surface as close as possible to the intersection of the horizontal and vertical faces.
- Obtain at least one sample increment of equal size from each of the top, middle, and bottom thirds of the pile.
- Combine the increments to form a single sample.

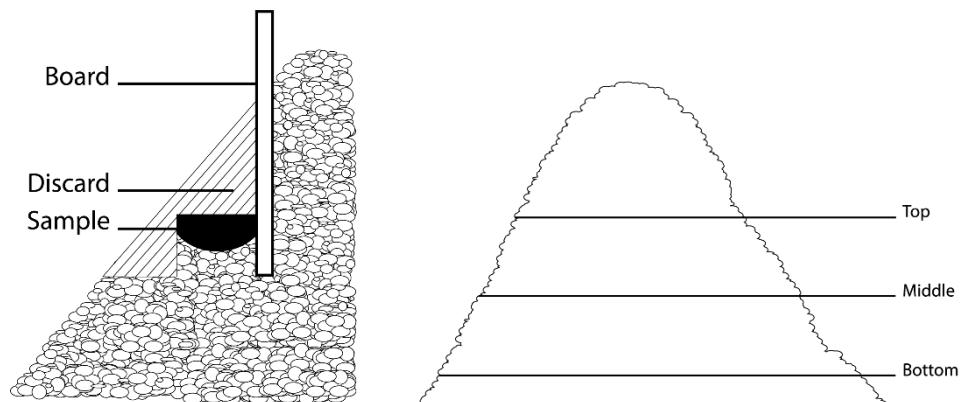

Identification and Shipping

- Identify sample containers as required by the agency.
- Ship samples in containers that will prevent loss, contamination, or damage.

Report

- On forms approved by the agency
- Sample ID
- Date
- Time
- Location
- Quantity represented

ATM 403 Sampling Asphalt Mixtures

1. Scope

This method describes procedures used for sampling Asphalt Mixtures.

2. Significance and Use

This method provides procedures for sampling Asphalt Mixtures in the field. Sampling is equally as important as the testing, and the sampler shall use every precaution to obtain samples that will yield an acceptable estimate of the nature and conditions of the materials for which they represent. Care shall be taken in sampling to avoid segregation of the material being sampled, and to prevent contamination by dust or other foreign matter.

If material is sampled by other than DOT&PF personnel or their agent(s), the sampling must be witnessed and possession of the sample transferred immediately to DOT&PF personnel or their agent(s).

The method of sampling must be approved at the project level.

3. Equipment

- Flat scoop with vertical sides or a square point shovel.
- Plate with small lip (approximately ½”) and of sufficient size and rigidity to accommodate required sample. Plate to have wire(s) attached to allow the plate to be located and removed from the mat after paver travels past it.
- Approved sample containers including new cardboard boxes, clean metal buckets, cans or bowls.
- Miscellaneous tools, scraper, scoop, gloves, etc.

4. Sampling from the Auger (Not Allowed on FHWA Projects)

1. Obtain samples from the accessible portion of the auger, using a square point shovel.
2. Place the shovel in front of the auger, with the blade flat upon the surface to be paved.
3. Allow the front face of the Asphalt Mixture coming off the auger to cover the shovel. Remove the shovel before the auger reaches the shovel by lifting it upward as vertically as possible being careful not to lose material.
4. Repeat the procedure at least three times, but as many times as necessary to obtain a sample of the required size.
5. Place the sample in an approved container for transport to Lab.

5. Lipped Plate Sampling

1. When using a pickup machine:
 - a. Stop the paver and pickup machine.
 - b. Place plate(s) underneath the pickup machine, midway between and just behind the rear tires and right in front of the paver.
2. When using dump trucks:
 - a. Stop the paver after the truck is attached to the paver.
 - b. Place plate(s) at the midpoint of the axis of the paver and behind the truck tires.

Note 1: When placing plate(s), avoid influence from truck tires, pickup machine tires, and paver tracks or tires.

3. Run an attached wire perpendicular to the direction of the paver, beyond the farthest auger extension and/or the ski.
4. Hold the wire to the ground with your foot.
5. Allow the paving operation to resume.
6. When the paver has passed over the plate position, pull up on the wire to locate the plate. Remove the plate(s) laden with mix from the **Asphalt Mixture** mat by lifting vertically being careful not to disturb the mix at the edge of the plate.
7. Place the entire sample in an approved container(s) for transport to the Lab

Note 2: Make sure to hold the wire down on the ground so the ski will not snag it.

6. Windrow Sampling

1. Sample from the windrow created by a single truck. Visually divide the windrow length into three equal sections.
2. Sample from the middle of each of the three sections as shown in the diagrams below. Remove and discard the top 12 inches of material. Remove one increment for each required sample, from each location by digging vertically down with a square point shovel.
3. Place each sample increment from the first location into separate approved containers. Move to the second location and add one sample increment to each container. Move to third location and repeat sampling.
4. Place the acceptance sample containers in an insulated box for transport to the Lab.

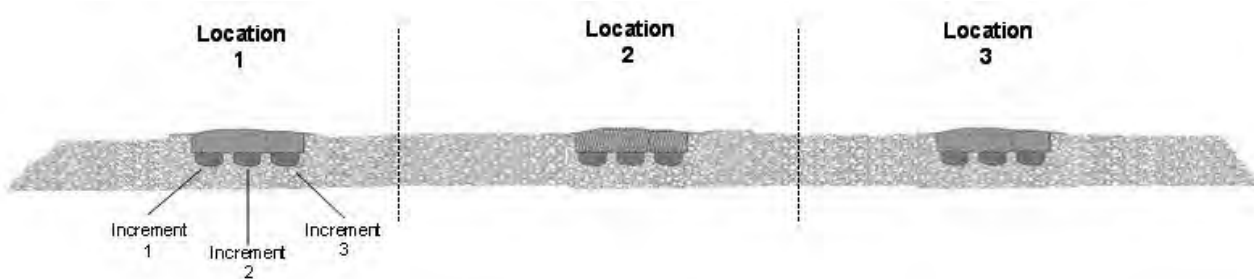

Windrow Longitudinal Section

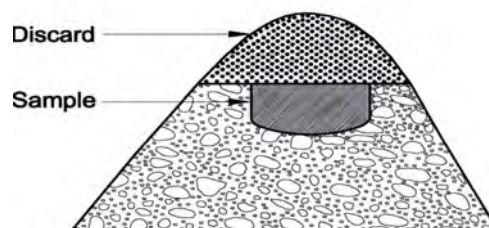

Windrow Cross Section

ATM 404 Reducing Samples of Asphalt Mixtures to Testing Size

Following are guidelines for the use of WAQTC FOP for AASHTO R 47 by the State of Alaska DOT&PF.

1. The incremental method may be done without sheeting.
2. When project specifications allow the use of a mechanical splitter, care must be taken to ensure the splitter is level.
3. Aerosol vegetable cooking spray is approved as a release agent.
4. Under Procedure Mechanical Splitter Type B (Riffle) insert image:



a.

This page intentionally left blank.

REDUCING SAMPLES OF ASPHALT MIXTURES TO TESTING SIZE FOP FOR AASHTO R 47

Scope

This procedure covers sample reduction of asphalt mixtures to testing size in accordance with AASHTO R 47-19. The reduced portion is to be representative of the original sample.

Apparatus

- Thermostatically controlled oven capable of maintaining a temperature of at least 110°C (230°F) or high enough to heat the material to a pliable condition for splitting.
- Non-contact temperature measuring device.
- Metal spatulas, trowels, metal straightedges, drywall taping knives, or a combination thereof; for removing asphalt mixture samples from the quartering device, cleaning surfaces used for splitting, etc.
- Square-tipped, flat-bottom scoop, shovel, or trowel for mixing asphalt mixture before quartering.
- Miscellaneous equipment including hot plate, non-asbestos heat-resistant gloves or mittens, pans, buckets, and cans.
- Sheeting: Non-stick heavy paper or other material as approved by the agency.
- Agency-approved release agent, free of solvent or petroleum-based material that could affect asphalt binder.
- Mechanical Splitter Type B (Riffle): having a minimum of eight equal-width chutes discharging alternately to each side with a minimum chute width of at least 50 percent larger than the largest particle size. A hopper or straight-edged pan with a width equal to or slightly smaller than the assembly of chutes in the riffle splitter to permit uniform discharge of the asphalt mixture through the chutes without segregation or loss of material. Sample receptacles of sufficient width and capacity to receive the reduced portions of asphalt mixture from the splitter without loss of material.
- Quartering Template: formed in the shape of a cross with equal length sides at right angles to each other. Template shall be manufactured of metal that will withstand heat and use without deforming. The sides of the quartering template should be sized so that the length exceeds the diameter of the flattened cone of asphalt mixture by an amount allowing complete separation of the quartered sample. Height of the sides must exceed the thickness of the flattened cone of asphalt mixture.
- Non-stick mixing surface that is hard, heat-resistant, clean, level, and large enough to permit asphalt mixture samples to be mixed without contamination or loss of material.

Sampling

Obtain samples according to the FOP for AASHTO R 97.

Sample Preparation

The sample must be warm enough to separate. If not, warm in an oven until it is sufficiently soft to mix and separate easily. Do not exceed either the temperature or time limits specified in the test method(s) to be performed.

Selection of Procedure (Method)

Refer to agency requirements when determining the appropriate method(s) of sample reduction. In general, the selection of a particular method to reduce a sample depends on the initial size of the sample vs. the size of the

sample needed for the specific test to be performed. It is recommended that, for large amounts of material, the initial reduction be performed using a mechanical splitter. This decreases the time needed for reduction and minimizes temperature loss. Further reduction of the remaining asphalt mixture may be performed by a combination of the following methods, as approved by the agency.

The methods for reduction are:

- Mechanical Splitter Type B (Riffle) Method
- Quartering Method
 - Full Quartering
 - By Apex
- Incremental Method

Procedure

When heating of the equipment is desired, it shall be heated to a temperature not to exceed the maximum mixing temperature of the job mix formula (JMF).

Mechanical Splitter Type B (Riffle) Method

1. Clean the splitter and apply a light coating of approved release agent to the surfaces that will come in contact with asphalt mixture (hopper or straight-edged pan, chutes, receptacles).
2. Place two empty receptacles under the splitter.
3. Carefully empty the asphalt mixture from the agency-approved container(s) into the hopper or straight-edged pan without loss of material. Uniformly distribute from side to side of the hopper or pan.
4. Discharge the asphalt mixture at a uniform rate, allowing it to flow freely through the chutes.
5. Any asphalt mixture that is retained on the surface of the splitter shall be removed and placed into the appropriate receptacle.
6. Reduce the remaining asphalt mixture as needed by this method or a combination of the following methods as approved by the agency.
7. Using one of the two receptacles containing asphalt mixture, repeat the reduction process until the asphalt mixture contained in one of the two receptacles is the appropriate size for the required test.
8. After each split, remember to clean the splitter hopper and chute surfaces if needed.
9. Retain and properly identify the remaining unused asphalt mixture sample for further testing if required by the agency.

Quartering Method

1. If needed, apply a light coating of release agent to quartering template.
2. Dump the sample from the agency approved container(s) into a conical pile on a hard, “non-stick,” clean, level surface where there will be neither a loss of material nor the accidental addition of foreign material. The surface can be made non-stick by the application of an approved asphalt release agent, or sheeting.
3. Mix the material thoroughly by turning the entire sample over a minimum of four times with a flat-bottom scoop; or by alternately lifting each corner of the sheeting and pulling it over the sample diagonally toward the opposite corner, causing the material to be rolled. Create a conical pile by either depositing each scoop or shovelful of the last turning on top of the preceding one or lifting both opposite corners.

4. Flatten the conical pile to a uniform diameter and thickness where the diameter is four to eight times the thickness. Make a visual observation to ensure that the material is homogeneous.
5. Divide the flattened cone into four equal quarters using the quartering template or straightedges assuring complete separation.
6. Reduce to appropriate sample mass by full quartering or by apex.

Full Quartering

- a. Remove diagonally opposite quarters, including all of the fine material, and place in a container to be retained.
- b. Remove the quartering template, if used.
- c. Combine the remaining quarters.
- d. If further reduction is necessary, repeat Quartering Method Steps 3 through 6.
- e. Repeat until appropriate sample mass is obtained. The final sample must consist of the two remaining diagonally opposite quarters.
- f. Retain and properly identify the remaining unused portion of the asphalt mixture sample for further testing if required by the agency.

Reducing by Apex

- a. Using a straightedge, slice through a quarter of the asphalt mixture from the center point to the outer edge of the quarter.
- b. Pull or drag the material from the quarter with two straight edges or hold one edge of the straightedge in contact with quartering device.
- c. Remove an equal portion from the diagonally opposite quarter and combine these increments to create the appropriate sample mass.
- d. Continue using the apex method with the unused portion of the asphalt mixture until samples have been obtained for all required tests.
- e. Retain and properly identify the remaining unused portion of the asphalt mixture sample for further testing if required by the agency.

Incremental Method

1. Cover a hard, clean, level surface with sheeting. This surface shall be large enough that there will be neither a loss of material nor the accidental addition of foreign material.
2. Place the sample from the agency approved container(s) into a conical pile on that surface.
3. Mix the material thoroughly by turning the entire sample over a minimum of four times:
 - a. Use a flat-bottom scoop; or
 - b. Alternately lift each corner of the sheeting and pull it over the sample diagonally toward the opposite corner, causing the material to be rolled.
4. Create a conical pile by either depositing each scoop or shovelful of the last turning on top of the preceding one or lifting both opposite corners.

5. Grasp the sheeting and roll the conical pile into a cylinder (loaf), then flatten the top. Make a visual observation to determine that the material is homogenous.
6. Remove one quarter of the length of the loaf and place in a container to be saved by either:
 - a. Pull sheeting over edge of counter and drop material into container.
 - b. Use a straightedge at least as wide as the full loaf to slice off material and place into container.
7. Obtain an appropriate sample mass for the test to be performed; by either:
 - a. Pull sheeting over edge of counter and drop cross sections of the material into container until proper sample mass has been obtained.
 - b. Use a straightedge at least as wide as the full loaf to slice off cross sections of the material until proper sample mass has been obtained and place into container.

Note 1: When reducing the sample to test size it is advisable to take several small increments, determining the mass each time until the proper minimum size is achieved. Unless the sample size is grossly in excess of the minimum or exceeds the maximum test size, use the sample as reduced for the test.

8. Repeat Step 7 until all the samples for testing have been obtained or until final quarter of the original loaf is reached.
9. Retain and properly identify the remaining unused portion of the asphalt mixture sample for further testing if required by the agency.

ATM 405 Asphalt Binder Content of Asphalt Mixtures by the Nuclear Method

1. Scope

This method covers the quantitative determination of the asphalt cement content of Asphalt Mixtures by testing a sample with a device that utilizes neutron thermalization techniques. This is an adaptation of AASHTO T 287. Job mix design (JMD) calibration, cross calibration of master and field gauges and calibration transfer are included.

2. Referenced Documents

- WAQTC Standards:
 - FOP for AASHTO T 2 (ASTM D75) , Sampling of Aggregates
 - FOP for AASHTO R 97 (ASTM D979), Sampling Asphalt Mixtures
 - FOP for AASHTO R47, Reducing Samples of Asphalt Mixtures to Testing Size
 - FOP for AASHTO T 329, Moisture Content of Asphalt Mixtures by Oven Method
- Other Documents:
 - Manufacturer's instruction manual. Significance and Use

This method can be used for rapidly determining the binder content of Asphalt Mixtures. Testing can be completed in a matter of minutes so that adjustments, if necessary, can be made in the asphalt metering system with a limited amount of mix production. The procedure is useful in the determination of binder content only, as it does not provide extracted aggregate for the gradation analysis.

3. Apparatus

- Nuclear asphalt content gauge system consisting of:
 - Neutron source: an encapsulated and sealed radioactive source
 - Thermal neutron detectors
 - Read-out instrument displaying, at a minimum, percent binder.
 - Two or more stainless steel sample pans conforming to gauge requirements
- Sample containers with lids or other methods of closing to prevent contamination and of sufficient size to hold the entire sample. The containers should be able to withstand the reheating of the mix to mixing temperature.
- Sample quartering apparatus conforming to requirements of the WAQTC FOP for AASHTO R 47.
- Balance or scale: capable of determining mass to 15 kg, readable to 1 g and conforming to AASHTO M 231.
- Drying oven, of either of the following types, capable of handling the volume and sample size expected for the project:
 - Forced air, ventilated or convection oven capable of maintaining a temperature of $177 \pm 3^{\circ}\text{C}$ ($350 \pm 5^{\circ}\text{F}$)

- Leveling plate: Flat, rigid plate of metal with a minimum thickness of 10 mm ($\frac{3}{8}$ in) and slightly larger than the sample pans
- Thermometer with a temperature range of 10-300°C (50-500°F)
- Assorted pans, spoons, spatulas, and mixing bowls
- Radioactive materials information and calibration packet containing:
 - Daily Background Count Log
 - Leak Test Certificate
 - Shippers Declaration for Dangerous Goods
 - Procedure Memo for Storing, Transporting and Handling Nuclear Testing Equipment
 - Other radioactive materials documentation as required by local regulatory requirements

4. Precautions

1. The equipment shall be so constructed as to be licensable in accordance with applicable health and safety regulations.
2. Equipment operators shall wear an approved form of radiation dosimetry (i.e., film badges, thermo luminescent dosimeter, etc.) capable of monitoring the occupational radiation exposure.
3. Since nuclear equipment measures the total amount of hydrogen in the sample, this procedure is sensitive to changes in moisture content. It must be remembered that both asphalt cement and water contain hydrogen.
4. Keep any other source of neutron radiation at least 10 m (30 ft.) from the equipment. Do not place the equipment where large amounts of hydrogenous material may be moved during the calibration or testing procedures (for example, water or plastic materials).
5. All personnel shall be kept at least 1 m (3 ft.) away from the gauge during testing.

5. Standardization

1. Obtain and record a 16 minute background count, in accordance with manufacturer's procedure, each day prior to taking test measurements or whenever the gauge has been moved or the conditions within 1 m (3 ft) of the gauge have changed. The measurement time for the background count is the same as that used for test measurements.
2. If the background count has not changed by more than 2 percent from the previous background count, then the apparatus shall be considered stable and acceptable for use. If the gauge has been moved or if the surrounding conditions have changed, additional background counts must be obtained until the 2 percent standard is met.

6. Calibration

1. This method is sensitive to the type of aggregate, percentage and source of asphalt binder, and to the aggregate gradation. Accordingly, a calibration curve must be developed for each mix type. When changes occur, a new calibration should be run. The curve shall be established with 3 points. (See **Appendix A**)
2. Prior to the start of each test, verify that the activated calibration is correct.

7. Procedure

1. Determine the mass of a clean gauge sample pan, and use this to determine the sample mass in the pan, or tare the pan on the scale.
2. Using an **Asphalt Mixture** sample having a temperature of 121° to 149°C (250° to 300°F) obtained in accordance with WAQTC FOP for AASHTO T 168, and reduced in accordance with WAQTC FOP for AASHTO R 47, fill the sample pan one-half full, evenly distributing the sample in the pan. Level the asphalt concrete mixture with a preheated trowel or spatula, spading as necessary to compact (usually 10 to 15 spades are sufficient), being careful to avoid segregating the mix or driving the fines into the bottom.
3. Fill the remainder of the pan until the mass of the **asphalt mixture** in the pan is approximately equal to or up to 5 grams above the mass of mix used for the calibration samples. Level the top of the **asphalt mixture** using a spatula or trowel and spade as necessary to compact (usually 10 to 15 spades are sufficient), avoiding segregation of the mix. Compact the sample into the pan, until it is level with the top of the pan, by standing on the metal plate and rocking/twisting back-and-forth.
4. Verify that the mass of mix is ± 5 g of the calibration mass. Record the mass of the **asphalt mixture** in the pan.
5. If the gauge does not have temperature compensation capability, measure and record the temperature of the compacted specimen. This temperature must be within $\pm 5^{\circ}\text{C}$ ($\pm 9^{\circ}\text{F}$) of the calibration test specimen temperature.
6. Place the pan into the gauge. Perform a 16 minute count.
7. Determine and record the uncorrected asphalt **binder** content to the nearest 0.01 percent by direct readout from the gauge, from the calibration graph, or by the formula supplied by the manufacturer.
8. Using a representative portion of the original sample or a portion of the material removed from the gauge pan, determine the moisture in the mixture in accordance with the WAQTC FOP for AASHTO T 329 and record to the nearest 0.01 percent.

Note 1: When taking the moisture from the gauge pan sample, remove it immediately after completing the oil content test.

8. Calculation

Subtract the moisture content from the uncorrected asphalt **binder** content. Record this as the corrected asphalt **binder** content.

9. Report

- Results shall be reported on standard forms approved by the Department.
- Make, model, and serial number of the nuclear asphalt content gauge.
- Date and source of calibration.
- Date of test.
- Name and signature of operator.
- Background count for the day of the test.
- Mix identification.
- Aggregate type and source(s); Asphalt **binder** source, type and grade.

- Calibration sample mass and temperature.
- Test sample mass and temperature, if gauge does not have temperature compensation capability
- Gauge reading, including print-out from gauge.
- Asphalt binder content value to the nearest 0.1 %.
- Attach the Nuclear Gauge print out to the report.

Appendix A ATM 405

Gauge Calibration

1. Obtain samples of aggregate in accordance with WAQTC FOP for AASHTO T 2 (ASTM D75). Approximately 50 kg (110 lb.) total will be required for calibration specimens. Dry the aggregates in accordance with WAQTC FOP for AASHTO T 255/T 265, separate into sieve sizes determined by the JMD.
2. Blend the aggregate together at the proper proportion to match the job mix formula following steps 3 and 4.
3. Calculate the required cumulative mass for each specified sieve using the following formula:

$$X = \frac{(100 - P)}{100} \times T$$

Where:

- X = Required cumulative batch mass for each specified sieve
- P = Percent passing for each specified sieve according to the job mix formula
- T = Initial total aggregate mass

4. Correct for aggregate dust as follows.
 - a. Prepare a wash gradation sample from the mass calculated in Step 4.
 - b. Perform a washed gradation following WAQTC FOP for AASHTO T 27/T 11.
 - c. Compute the corrected batch mass for each specified sieve for the calibration points using the following formula:

$$Z_n = \frac{X^2}{Y}$$

Where:

- Z_n = Adjusted cumulative batch mass for sieve size n.
- X = Pre-wash cumulative batch mass for each specified sieve.
- Y = Post-wash cumulative batch mass for each specified sieve.

5. Obtain samples of bituminous materials in accordance with WAQTC FOP for AASHTO T 40. Approximately 4 L (1 gal) will be required.
6. Calculate the mass of asphalt cement for each calibration point as follows:

$$B = E \times P_{bm}$$

Where:

- B = mass of asphalt cement to the nearest 0.1 g
- E = mass of mix
- P_{bm} = percent asphalt cement content by total mass of mixture, expressed as a decimal.

7. Use the three following asphalt cement contents:
 - a. Specified minus 1.0 percent
 - b. Specified (mix design value)

c. Specified plus 1.0 percent

8. Calculate the mass of aggregate required for each calibration point as follows:

$$A = E - B$$

Where:

A = mass of aggregate to the nearest 0.1 g

B = mass of asphalt cement to the nearest 0.1 g

E = mass of mix

Preparation of Calibration Specimens

1. Heat the prepared aggregate specimens to the mixing temperature range midpoint for the asphalt cement $\pm 5^{\circ}\text{C}$ ($\pm 9^{\circ}\text{F}$) and hold at that temperature for three hours or to constant mass.
2. Heat the asphalt cement to the mid-point of the mixing temperature range $\pm 5^{\circ}\text{C}$ ($\pm 9^{\circ}\text{F}$) in a covered container(s). It is best to use the asphalt cement as soon as it reaches mixing temperature. If this is not possible, maintain the asphalt cement at this temperature, rather than cool and reheat it, but do not hold the sample at this temperature for more than 4 hours.
3. All bowls, sample pans, and tools should be heated to the mid-point of the mixing temperature range $\pm 5^{\circ}\text{C}$ ($\pm 9^{\circ}\text{F}$). An initial or “butter” mix is required to condition the mixing equipment. Mix a minimum of three asphalt concrete specimens to cover the approximate range of the design asphalt content. Mix one at the design asphalt content, one 1.0 percent above, and one 1.0 percent below, use the same grade and type of asphalt as will be used in the asphalt concrete mixture to be tested. Mix 7000-9000g for each specimen.
4. Fill the sample pan one-half full, evenly distributing the sample in the pan. Level the asphalt concrete mixture with a spatula or trowel and spade as necessary to compact, avoiding segregation of the mix. Fill the remainder of the pan until the asphalt concrete mixture is mounded slightly above the top of the pan. Record the weight of the asphalt concrete mixture in the pan. This is the weight that is to be used for all calibration and test samples using this calibration. Level the top of the asphalt concrete mixture using a spatula or trowel and spade as necessary to compact, avoiding segregation of the mix. Use the metal plate to consolidate the asphalt concrete mixture until it is level with the top edge of the pan. All specimens should be compacted at the mid-point of the mixing temperature range $\pm 5^{\circ}\text{C}$ ($\pm 9^{\circ}\text{F}$) to ensure that the mix will compact properly.
5. Place each calibration pan into the gauge and proceed in accordance with the manufacturer’s instructions for operation of the equipment and the sequence of operations. Count each calibration sample for 16 minutes.

Note 1: Do not forget to perform and record a background count as per the manufacturer’s instructions.

6. For gauges that generate the calibration internally, print out the formula coefficients (“A” Values), the coefficient of fit and the calculated percent difference for each calibration point. The coefficient of fit must be between 0.998 and 1.000 for dense graded mix or 0.995 and 1.000 for open graded mix. Calibration points must have a calculated percent difference of less than 0.09 percent. If either requirement is not met, the calibration must be redone.
7. Store the acceptable calibration in the gauge’s memory, using the job mix formula and the Contract number or an easily recognizable calibration number, according to the manufacturer’s instructions.
8. For gauges other than the Troxler, prepare a calibration curve by plotting the calibration sample gauge readings versus asphalt cement content on linear graph paper, choosing convenient scale factors for gauge readings and asphalt cement content.

9. Calculate the correlation factor for gauges without internal calculations according to the following formula:

$$\text{CorrelationFactor} = \sqrt{1 - \frac{\sum_i (Y_i - \hat{Y}_i)^2}{\sum_i (Y_i - \bar{Y}_i)^2}}$$

Where:

Y_i = actual percent asphalt values for each sample

\hat{Y}_i = calculated percent asphalt values from curve

\bar{Y}_i = mean value of the actual percentages asphalt, and

I = number of calibration samples.

Appendix B ATM 405

Cross Calibration (Troxler 3241)

1. Cross calibrating creates a relationship between the field gauge and a master gauge. This allows testing of production mix with a field gauge without the need to perform physical calibrations. When several gauges are cross calibrated, the mix calibrations may be transferred to each. The master gauge is normally located where the calibration sample pans are fabricated.
2. The central lab shall prepare the cross calibration samples. Prepare six calibration samples, using a locally available specification aggregate, with binder contents between 3 and 8 percent at 1 percent increments or per the gauge manufacturer's instructions. Mix the samples so that each pan of mix equals the base mass ± 5 g. Run each sample in the master gauge using a 16 minute count in the normal calibration mode. After all samples are run, the gauge will automatically calculate a coefficient of fit. The coefficient of fit must be at least 0.999.
3. Seal each pan to prevent change in hydrogen content and repeat steps 1 and 2. Sealed pans must meet same criteria.
4. Run each of the six sealed calibration samples in the field gauge while in cross calibration mode utilizing a 16 minute count. For each calibration sample, input the information from the master gauge into the field gauge. When the six cross calibration samples have been counted, print out the cross calibration data. The coefficient of fit must be .999 or 1.000. If this requirement is met, the master gauge and the field gauge are cross calibrated.

Calibration Transfer

When the field gauge has been cross calibrated with the master gauge a calibration transfer can be performed. JMD calibrations can now be transferred to the field gauge, using input data only. This transfer would be in lieu of calibrating the field gauge with a JMD calibration. Follow the manufacturer's instructions to perform this transfer.

ATM 406 Determining the Asphalt Binder Content of Asphalt Mixtures by the Ignition Method

Following are guidelines for the use of WAQTC FOP for AASHTO T 308 by the State of Alaska DOT&PF.

1. Delete Table 1 and replace with:

Nominal Maximum Aggregate Size* mm (in.)	Minimum Mass Specimen g	Maximum Mass Specimen g
37.5 (1 ½)	4000	4500
25.0 (1)	3000	3500
19.0 (¾)	2000	2500
12.5 (½)	2000	2500
9.5 (3/8)	1200	1700
4.75 (No. 4)	1200	1700

2. When the total mass recorded in Procedure - Method A step 10 exceeds ± 5 g, inspect the internal scale and exhaust system to verify no issues are present.
3. Delete Step 9 in Correction Factors – Procedure.
4. Unless otherwise specified, Method A (using Method B calculation following step 20) shall be used.
5. Verify oven balance accuracy with standard masses to 0.1 gram tolerance, prior to calibration and testing. Recommend sending 1.00 kilogram standard mass with all field labs.
6. Asphalt binder content shall be calculated with masses determined on an external balance.
This applies to all test samples as well as calibration samples.
7. Nominal Maximum size shall be determined by the Job Mix Formula target value gradation.
8. Determine Mf 30 to 60 minutes after removing from oven.
9. Corrected asphalt binder content reported to 0.1 percent.
10. Use of the printed ticket is optional.

This page intentionally left blank.

DETERMINING THE ASPHALT BINDER CONTENT OF ASPHALT MIXTURES BY THE IGNITION METHOD

FOP FOR AASHTO T 308

Scope

This procedure covers the determination of asphalt binder content of asphalt mixtures by ignition of the binder in accordance with AASHTO T 308-22.

Overview

The sample is heated in a furnace at 538°C (1000°F) or less; samples may be heated by convection or direct infrared irradiation (IR). The aggregate remaining after burning can be used for sieve analysis using the FOP for AASHTO T 30.

Some agencies allow the use of recycled asphalt mixtures. When using recycled asphalt mixtures, check with the agency for specific correction procedures.

Asphalt binder in the asphalt mixture is ignited in a furnace. Asphalt binder content is calculated as the percentage difference between the initial mass of the asphalt mixture and the mass of the residual aggregate, with the asphalt binder correction factor, and moisture content subtracted. The asphalt binder content is expressed as percent of moisture-free mix mass.

Two methods, A and B, are presented.

Apparatus

Note 1: The apparatus must be calibrated for the specific mix design. See “Correction Factors” at the end of this FOP.

The apparatus for the Methods A and B is the same except that the furnace for Method A requires an internal balance.

- Ignition Furnace: A forced-air ignition furnace that heats the specimens by either the convection or direct IR irradiation method. The convection-type furnace must be capable of maintaining the temperature between at least 530 and 545°C (986 and 1013°F) and have a temperature control accurate within ±5°C (±9°F).

For Method A, the furnace will be equipped with an internal scale thermally isolated from the furnace chamber and accurate to 0.1 g. The scale shall be capable of determining the mass of a 3500 g sample in addition to the sample baskets. A data collection system will be included so that mass can be automatically determined and displayed during the test. The furnace shall have a built-in computer program to calculate the change in mass of the sample and provide for the input of a correction factor for aggregate loss. The furnace shall provide a printed ticket with the initial specimen mass, specimen mass loss, temperature compensation, correction factor, corrected asphalt binder content, test time, and test temperature. The furnace shall provide an audible alarm and indicator light when the sample mass loss does not exceed 0.01 percent of the total sample mass for three consecutive minutes. Perform lift test according to manufacturer’s instructions weekly during use, if applicable. The furnace shall be designed to permit the operator to change the ending mass loss percentage from both 0.01 percent to 0.02 percent.

For both Method A and Method B, the furnace chamber dimensions shall be adequate to accommodate a 3500 g sample. The furnace door shall be equipped so that it cannot be opened during the ignition test. A method for reducing furnace emissions shall be provided and the furnace shall be vented so that no emissions escape into the laboratory. The furnace shall have a fan to pull air through the furnace to expedite the test and to eliminate the escape of smoke into the laboratory.

- Sample Basket Assembly: consisting of sample basket(s), catch pan, and basket guards. Sample basket(s) will be of appropriate size allowing samples to be thinly spread and allowing air to flow through and around the sample particles. Sets of two or more baskets shall be nested. A catch pan: of sufficient size to hold the

sample basket(s) so that aggregate particles and melting asphalt binder falling through the screen mesh are caught. Basket guards will completely enclose the basket and be made of screen mesh, perforated stainless steel plate, or other suitable material.

- Thermometer, or other temperature measuring device, with a temperature range of 10 -260°C (50-500°F).
- Oven capable of maintaining 110 ±5°C (230 ±9°F).
- Balance or scale: Capacity sufficient for the sample mass and conforming to the requirements of M 231, Class G2.
- **Safety equipment:** Safety glasses or face shield, high temperature gloves, long sleeved jacket, a heat resistant surface capable of withstanding 650°C (1202°F), a protective cage capable of surrounding the sample baskets during the cooling period, and a particle mask for use during removal of the sample from the basket assembly.
- Miscellaneous equipment: A container larger than the sample basket(s) for transferring sample after ignition, large flat pan, spatulas, bowls, and wire brushes.

Sampling

1. Obtain samples of asphalt mixture in accordance with the FOP for AASHTO R 97.
2. Reduce asphalt mixture samples in accordance with the FOP for AASHTO R 47.
3. If the mixture is not sufficiently soft to separate with a spatula or trowel, place it in a large flat pan in an oven at 110 ±5°C (230 ±9°F) until soft enough.
4. Test sample size shall conform to the mass requirement shown in Table 1.

Note 2: When the mass of the test specimen exceeds the capacity of the equipment used or for large samples of fine mixes, the test specimen may be divided into suitable increments, tested, and the results appropriately combined through a weighted average for calculation of the asphalt binder content.

Table 1

Nominal Maximum Aggregate Size* mm (in.)	Minimum Mass Specimen g	Maximum Mass Specimen g
37.5 (1 ½)	4000	4500
25.0 (1)	3000	3500
19.0 (¾)	2000	2500
12.5 (½)	1500	2000
9.5 (3/8)	1200	1700
4.75 (No. 4)	1200	1700

* One sieve larger than the first sieve to retain more than 10 percent of the material using an agency specified set of sieves based on cumulative percent retained. Where large gaps in specification sieves exist, intermediate sieve(s) may be inserted to determine nominal maximum size.

Procedure – Method A (Internal Balance)

1. For the convection-type furnace, preheat the ignition furnace to 538 ± 5°C (1000 ± 9°F) or to the temperature determined in the Correction Factors Annex of this method. Manually record the furnace temperature (set point) before the initiation of the test if the furnace does not record automatically. For the direct IR irradiation-type furnace, use the same burn profile as used during the correction factor determination.
2. Dry the sample to constant mass, according to the FOP for AASHTO T 329; or determine the moisture content of a companion sample in accordance with the FOP for AASHTO T 329.

3. Determine and record the mass of the sample basket assembly to the nearest 0.1 g.
4. Evenly distribute the sample in the sample basket assembly, taking care to keep the material away from the edges of the basket. Use a spatula or trowel to level the sample.
5. Determine and record the total mass of the sample and sample basket assembly at room temperature to the nearest 0.1 g.
6. Calculate the initial mass of the sample by subtracting the mass of the sample basket from the mass of the sample and sample basket assembly and record to the nearest 0.1 g. Designate this mass as (M_i).
7. Record the correction factor or input into the furnace controller for the specific asphalt mixture.
8. Input the initial mass of the sample (M_i) into the ignition furnace controller. Verify that the correct mass has been entered.
9. Verify the furnace scale is reading zero, if not, reset to zero.

CAUTION: Operator should wear safety equipment – high temperature gloves, face shield, fire-retardant shop coat – when opening the door to load or unload the sample.

10. Open the chamber door and gently set the sample basket assembly in the furnace. Carefully position the sample basket assembly so it is not in contact with the furnace wall. Close the chamber door and verify that the sample mass displayed on the furnace scale equals the total mass of the sample and sample basket assembly recorded in Step 5 within ± 5 g.

Note 3: Differences greater than 5 g or failure of the furnace scale to stabilize may indicate that the specimen basket assembly is contacting the furnace wall.

Note 4: Furnace temperature will drop below the set point when the door is opened but will recover when the door is closed, and ignition begins. Sample ignition typically increases the temperature well above the set point – relative to sample size and asphalt binder content.

11. Initiate the test by pressing the start button. This will lock the sample chamber and start the combustion blower.

Safety note: Do not attempt to open the furnace door until the asphalt binder has been completely burned off.

12. Allow the test to continue until the stable light and audible stable indicator indicate that the change in mass does not exceed 0.01 percent for three consecutive minutes. Press the stop button. This will unlock the sample chamber and cause the printer to print out the test results.

Note 5: An ending mass loss percentage of 0.02 may be used, if allowed by the agency, when aggregate that exhibits an excessive amount of loss during ignition testing is used.

13. Open the chamber door, remove the sample basket assembly, and place on the cooling plate or block. Place the protective cage over the sample basket assembly and allow it to cool to room temperature (approximately 30 minutes).

14. Determine and record the mass of the sample and sample basket assembly after ignition to the nearest 0.1 g.

15. Calculate the mass of the sample by subtracting the mass of the sample basket assembly from the mass of the sample and sample basket assembly and record to the nearest 0.1 g. Designate this mass as M_f .

16. Use the asphalt binder content percentage from the printed ticket. Subtract the moisture content and the correction factor if not entered into the furnace controller from the printed ticket asphalt binder content and report the difference as the corrected asphalt binder content.

Asphalt binder content percentage can also be calculated using the formula from “Method B” Step 16.

Calculation

Corrected asphalt binder content:

$$P_b = BC - MC - C_f^*$$

*If correction factor is not entered into the furnace controller

Where:

- P_b = the corrected asphalt binder content as a percent by mass of the asphalt mixture
- BC = asphalt binder content shown on printed ticket
- MC = moisture content of the companion asphalt mixture sample, percent, as determined by the FOP for AASHTO T 329 (if the specimen was oven-dried before initiating the procedure, MC=0)
- C_f = correction factor as a percent by mass of the asphalt mixture sample

Procedure – Method B (External Balance)

1. Preheat the ignition furnace to $538 \pm 5^\circ\text{C}$ ($1000 \pm 9^\circ\text{F}$) or to the temperature determined in the **Correction Factor Annex** of this method. Manually record the furnace temperature (set point) before the initiation of the test if the furnace does not record automatically.
2. Dry the sample to constant mass, according to the FOP for AASHTO T 329; or determine the moisture content of a companion sample in accordance with the FOP for AASHTO T 329.
3. Determine and record the mass of the sample basket assembly to the nearest 0.1 g.
4. Place the sample basket(s) in the catch pan. Evenly distribute the sample in the sample basket(s), taking care to keep the material away from the edges of the basket. Use a spatula or trowel to level the sample.
5. Determine and record the mass of the sample and sample basket assembly at room temperature to the nearest 0.1 g.
6. **Calculate the initial mass of the sample by subtracting the mass of the sample basket from the mass of the sample and sample basket assembly and record** to the nearest 0.1 g. Designate this mass as (M_i).
7. Record the correction factor for the specific asphalt mixture.
8. Open the chamber door and gently set the sample basket assembly in the furnace. Carefully position the sample basket assembly so it is not in contact with the furnace wall. Burn the asphalt mixture sample in the furnace for 45 minutes or the length of time determined in the “Correction Factors” section.
9. Open the chamber door, remove the sample basket assembly, and place on the cooling plate or block. Place the protective cage over the sample and allow it to cool to room temperature (approximately 30 min).
10. Determine and record **the mass of the sample and sample basket assembly to the nearest 0.1 g.**
11. **Calculate the sample mass by subtracting the mass of the sample basket assembly from the mass of the sample and sample basket assembly and record** to the nearest 0.1 g.
12. Place the sample basket assembly back into the furnace.
13. Burn the sample for at least 15 minutes after the furnace reaches the set temperature.
14. Open the chamber door, remove the sample basket assembly, and place on the cooling plate or block. Place the protective cage over the sample basket assembly and allow it to cool to room temperature (approximately 30 min.).

15. Determine and record the mass of the sample and sample basket assembly to the nearest 0.1 g.
16. Calculate the mass of the sample by subtracting the mass of the sample basket assembly from the mass of the sample and sample basket assembly and record to the nearest 0.1 g.
17. Repeat Steps 12 through 16 until the change in measured mass of the sample after ignition does not exceed 0.01 percent of the previous sample mass.

Note 5: An ending mass loss percentage of 0.02 may be used, if allowed by the agency, when aggregate that exhibits an excessive amount of loss during ignition testing is used.
18. Determine and record the mass of the sample and sample basket assembly to the nearest 0.1 g.
19. Calculate the final sample mass by subtracting the mass of the sample basket assembly and sample and sample basket assembly and record to the nearest 0.1 g. Designate this mass as M_f .
20. Calculate the asphalt binder content of the sample.

Calculations

Calculate the asphalt binder content of the sample as follows:

$$P_b = \frac{M_i - M_f}{M_i} \times 100 - MC - C_f$$

Where:

- P_b = the corrected asphalt binder content as a percent by mass of the asphalt mixture sample
- M_f = the final sample mass after ignition, g
- M_i = the initial mass of the asphalt mixture sample before ignition, g
- MC = moisture content of the companion asphalt mixture sample, percent, as determined by the FOP for AASHTO T 329 (if the specimen was oven-dried before initiating the procedure, MC = 0).
- C_f = correction factor as a percent by mass of the asphalt mixture sample

Example

Correction Factor	=	0.42%
Moisture Content	=	0.04%
Initial Mass of Sample and Basket	=	5292.7 g
Mass of Basket Assembly=		2931.5 g
M_i	=	2361.2 g
Total Mass after First ignition + basket	=	5154.4 g
Sample Mass after First ignition	=	2222.9 g
Sample Mass after additional 15 min ignition	=	2222.7 g

$$\%change = \frac{2222.9 \text{ g} - 2222.7 \text{ g}}{2222.9 \text{ g}} \times 100 = 0.009\%$$

%change is not greater than 0.01 percent, so M_f = 2222.7 g

$$P_b = \frac{2361.2 \text{ g} - 2222.7 \text{ g}}{2361.2 \text{ g}} \times 100 - 0.42\% - 0.04\% = 5.41\%$$

$$P_b = 5.41\%$$

Gradation

1. Empty contents of the basket(s) into a **container**, being careful to capture all material. Use a small wire brush to ensure all residual fines are removed from the baskets.

Note 7: Particle masks are a recommended safety precaution.

2. Perform the gradation analysis in accordance with the FOP for AASHTO T 30.

Report

- On forms approved by the agency
- Sample ID
- Method of test (A or B)
- Corrected asphalt binder content, P_b , **to the nearest 0.01 percent** or per agency standard
- Correction factor, C_f , to the nearest 0.01 percent
- Temperature compensation factor (Method A only)
- Total percent loss
- Sample mass
- Moisture content to the nearest 0.01%
- Test temperature

Attach the original printed ticket with all intermediate values (continuous tape) to the report for furnaces with internal balances.

ASPHALT BINDER AND AGGREGATE

(Mandatory Information)

Asphalt binder content results may be affected by the type of aggregate in the mixture and by the ignition furnace. Asphalt binder and aggregate correction factors must, therefore, be established by testing a set of correction specimens for each Job Mix Formula (JMF) mix design. Each ignition furnace will have its own unique correction factor determined in the location where testing will be performed.

This procedure must be performed before any acceptance testing is completed, and repeated each time there is a change in the mix ingredients or design. Any changes greater than 5 percent in stockpiled aggregate proportions should require a new correction factor.

All correction samples will be prepared by a central / regional laboratory unless otherwise directed.

Asphalt binder correction factor: A correction factor must be established by testing a set of correction specimens for each Job Mix Formula (JMF). Certain aggregate types may result in unusually high correction factors (> 1.00 percent). Such mixes should be corrected and tested at a lower temperature as described below.

Aggregate correction factor: Due to potential aggregate breakdown during the ignition process, a correction factor will need to be determined for the following conditions:

- a. Aggregates that have a proven history of excessive breakdown
- b. Aggregate from an unknown source.

This correction factor will be used to adjust the acceptance gradation test results obtained according to the FOP for AASHTO T 30.

Procedure

1. Obtain samples of aggregate in accordance with the FOP for AASHTO R 90.
2. Obtain samples of asphalt binder in accordance with the FOP for AASHTO R 66.
Note 8: Include other additives that may be required by the JMF.
3. Prepare an initial, or “butter,” mix at the design asphalt binder content. Mix and discard the butter mix before mixing any of the correction specimens to ensure accurate asphalt content.
4. Prepare two correction specimens at the JMF design asphalt binder content. Aggregate used for correction specimens shall be sampled from material designated for use on the project. An agency approved method will be used to combine aggregate. An additional “blank” specimen shall be batched and tested for aggregate gradation in accordance with the FOP for AASHTO T 30. The gradation from the “blank” shall fall within the agency specified mix design tolerances.
5. Place the freshly mixed specimens directly into the sample basket assembly. If mixed specimens are allowed to cool before placement in the sample basket assembly, the specimens must be dried to constant mass according to the FOP for AASHTO T 329. Do not preheat the sample basket assembly.
6. Test the specimens in accordance with Method A or Method B of the procedure.
7. Once both correction specimens have been burned, determine the asphalt binder content for each specimen by calculation or from the printed ignition furnace tickets, if available.
8. If the difference between the asphalt binder contents of the two specimens exceeds 0.15 percent, repeat with two more specimens and, from the four results, discard the high and low result. Determine the correction

factor from the two original or remaining results, as appropriate. Calculate the difference between the actual and measured asphalt binder contents for each specimen to 0.01 percent. The asphalt binder correction factor, C_f , is the average of the differences expressed as a percent by mass of asphalt mixture.

9. If the asphalt binder correction factor exceeds 1.00 percent, the test temperature must be lowered to $482 \pm 5^\circ\text{C}$ ($900 \pm 9^\circ\text{F}$) and new samples must be burned. If the correction factor is the same or higher at the lower temperature, it is permissible to use the higher temperature. The temperature for determining the asphalt binder content of asphalt mixture samples by this procedure shall be the same temperature determined for the correction samples.
10. For the direct IR irradiation-type burn furnaces, the **default** burn profile should be used for most materials. The operator may select burn-profile Option 1 or Option 2 to optimize the burn cycle. The burn profile for testing asphalt mixture samples shall be the same burn profile selected for correction samples.

Option 1 is designed for aggregate that requires a large asphalt binder correction factor (greater than 1.00 percent) – typically very soft aggregate (such as dolomite).

Option 2 is designed for samples that may not burn completely using the **default** burn profile.
11. Perform a gradation analysis on the residual aggregate in accordance with the FOP for AASHTO T 30, if required. The results will be utilized in developing an “Aggregate Correction Factor” and should be calculated and reported to 0.1 percent.
12. From the gradation results subtract the percent passing for each sieve, for each sample, from the percent passing each sieve of the “Blank” specimen gradation results from Step 4.
13. Determine the average difference of the two values. If the difference for any single sieve exceeds the allowable difference of that sieve as listed in Table 2, then aggregate gradation correction factors (equal to the resultant average differences) for all sieves shall be applied to all acceptance gradation test results determined by the FOP for AASHTO T 30. If the 75 μm (No. 200) is the only sieve outside the limits in Table 2, apply the aggregate correction factor to only the 75 μm (No. 200) sieve.

Table 2
Permitted Sieving Difference

Sieve	Allowable Difference
Sizes larger than or equal to 2.36 mm (No.8)	$\pm 5.0\%$
Sizes larger than to 75 μm (No.200) and smaller than 2.36 mm (No.8)	$\pm 3.0\%$
Sizes 75 μm (No.200) and smaller	$\pm 0.5\%$

Examples:

Sieve Size mm (in.)	Correction Factor Blank Sample % Passing	Correction Factor Sample #1 % Passing	Correction Factor Sample #2 % Passing	Difference 1 / 2	Avg. Diff.	Sieves to adjust
19.0 (3/4)	100	100	100	0/0	0.0	
12.5 (1/2)	86.3	87.4	86.4	-1.1/-0.1	-0.6	
9.5 (3/8)	77.4	76.5	78.8	+0.9/-1.4	-0.3	
4.75 (No. 4)	51.5	53.6	55.9	-2.1/-4.4	-3.3	
2.36 (No. 8)	34.7	36.1	37.2	-1.4/-2.5	-2.0	
01.18 (No. 16)	23.3	25.0	23.9	-1.7/-0.6	-1.2	
0.600 (No. 30)	16.4	19.2	18.1	-2.8/-1.7	-2.3	
0.300 (No. 50)	12.0	11.1	12.7	+0.9/-0.7	+0.1	
0.150 (No. 100)	8.1	9.9	6.3	-1.8/+1.8	0.0	
75 μm (No. 200)	5.5	5.9	6.2	-0.4/-0.7	-0.6	- 0.6

In this example, all gradation test results performed on the residual aggregate (FOP for AASHTO T 30) would have an aggregate correction factor applied to the percent passing the 75 µm (No. 200) sieve. The correction factor must be applied because the average difference on the 75 µm (No. 200) sieve is outside the tolerance from Table 2.

In the following example, aggregate correction factors would be applied to each sieve because the average difference on the 4.75 mm (No. 4) is outside the tolerance from Table 2.

Sieve Size mm (in.)	Correction Factor Blank Sample % Passing	Correction Factor Sample #1 % Passing	Correction Factor Sample #2 % Passing	Difference 1 / 2	Avg. Diff.	Sieves to adjust
19.0 (3/4)	100	100	100	0/0	0.0	0.0
12.5 (1/2)	86.3	87.4	86.4	-1.1/-0.1	-0.6	-0.6
9.5 (3/8)	77.4	76.5	78.8	+0.9/-1.4	-0.3	-0.3
4.75 (No. 4)	51.5	55.6	57.9	-4.1/-6.4	-5.3	-5.3
2.36 (No. 8)	34.7	36.1	37.2	-1.4/-2.5	-2.0	-2.0
01.18 (No. 16)	23.3	25.0	23.9	-1.7/-0.6	-1.2	-1.2
0.600 (No. 30)	16.4	19.2	18.1	-2.8/-1.7	-2.3	-2.3
0.300 (No. 50)	12.0	11.1	12.7	+0.9/-0.7	+0.1	+0.1
0.150 (No. 100)	8.1	9.9	6.3	-1.8/+1.8	0.0	0.0
75 µm (No. 200)	5.5	5.9	6.2	-0.4/-0.7	-0.6	-0.6

This page intentionally left blank.

ATM 407 Moisture Content of Hot Mix Asphalt by Oven Method

Following are guidelines for the use of WAQTC FOP for AASHTO T 329 by the State of Alaska DOT&PF.

1. In Procedure step #1, do not exceed Job Mix Formula (JMF) temperature.
2. Two additional drying options are offered for procedure step that do not require constant mass determination:
 - a. Dry test sample for 4 – 6 hours at 138 +/- 5 deg C (280 +/- 9 deg F)
 - b. Dry test sample for 8 – 16 hours at 110 +/- 5 deg C (230 +/- 9 deg F)

This page intentionally left blank.

MOISTURE CONTENT OF ASPHALT MIXTURES BY OVEN METHOD FOP FOR AASHTO T 329

Scope

This procedure covers the determination of moisture content of asphalt mixtures in accordance with AASHTO T 329-22.

Overview

Moisture content is determined by comparing the wet mass of a sample and the mass of the sample after drying to constant mass. The term constant mass is used to define when a sample is dry.

Constant mass – the state at which a mass does not change more than a given percent, after additional drying for a defined time interval, at a required temperature.

Apparatus

- Balance or scale: 2 kg capacity, readable to 0.1 g and conforming to AASHTO M 231.
- Forced draft, ventilated, or convection oven: Capable of maintaining the temperature surrounding the sample at $163 \pm 14^{\circ}\text{C}$ ($325 \pm 25^{\circ}\text{F}$).
- Sample Container: Clean, dry, not affected by heat and of sufficient size to contain a test sample without danger of spilling.
- Thermometer or other suitable device with a temperature range of 50 to 200°C (122 to 392°F) and readable to the nearest 2°C (4°F).

Sample

The test sample shall be obtained in accordance with the FOP for AASHTO R 97 and reduced in accordance with the FOP for AASHTO R 47. The size of the test sample shall be a minimum of 1000 g.

Procedure

1. Preheat the oven to the Job Mix Formula (JMF) mixing temperature range. If the mixing temperature is not supplied, a temperature of $163 \pm 14^{\circ}\text{C}$ ($325 \pm 25^{\circ}\text{F}$) is to be used.
2. Determine and record the mass of the sample container, including release media, to the nearest 0.1 g.
Note 1: When using paper or other absorptive material to line the sample container ensure it is dry before determining initial mass of sample container.
3. Place the test sample in the sample container.
4. Determine and record the temperature of the test sample.
5. Determine and record the total mass of the sample container and test sample to the nearest 0.1 g.
6. Calculate the initial, moist mass (M_i) of the test sample by subtracting the mass of the sample container as determined in Step 2 from the total mass of the sample container and the test sample as determined in Step 5.
7. The test sample shall be initially dried for 90 ± 5 minutes, and its mass determined. Then it shall be dried at 30 ± 5 minute intervals until further drying does not alter the mass by more than 0.05 percent.
8. Cool the sample container and test sample to $\pm 9^{\circ}\text{C}$ ($\pm 15^{\circ}\text{F}$) of the temperature determined in Step 4.
9. Determine and record the total mass of the sample container and test sample to the nearest 0.1 g.

10. Calculate the final, dry mass (M_f) of the test sample by subtracting the mass of the sample container as determined in Step 2 from the total mass of the sample container and the test sample as determined in Step 9.

Note 2: Moisture content and the number of samples in the oven will affect the rate of drying at any given time. Placing wet samples in the oven with nearly dry samples could affect the drying process.

Calculations

Constant Mass:

Calculate constant mass using the following formula:

$$\% \text{ Change} = \frac{M_p - M_n}{M_p} \times 100$$

Where:

M_p = previous mass measurement

M_n = new mass measurement

Example:

Mass of container: 232.6 g

Mass of container and sample after first drying cycle: 1361.8 g

Mass, M_p , of possibly dry sample: $1361.8 \text{ g} - 232.6 \text{ g} = 1129.2 \text{ g}$

Mass of container and possibly dry sample after second drying cycle: 1360.4 g

Mass, M_n , of possibly dry sample: $1360.4 \text{ g} - 232.6 \text{ g} = 1127.8 \text{ g}$

$$\% \text{ Change} = \frac{1129.2 \text{ g} - 1127.8 \text{ g}}{1129.2 \text{ g}} \times 100 = 0.12\%$$

0.12 percent is not less than 0.05 percent, so continue drying the sample.

Mass of container and possibly dry sample after third drying cycle: 1359.9 g

Mass, M_n , of dry sample: $1359.9 \text{ g} - 232.6 \text{ g} = 1127.3 \text{ g}$

$$\% \text{ Change} = \frac{1127.8 \text{ g} - 1127.3 \text{ g}}{1127.8 \text{ g}} \times 100 = 0.04\%$$

0.04 percent is less than 0.05 percent, so constant mass has been reached.

Moisture Content:

Calculate the moisture content, as a percent, using the following formula.

$$\text{Moisture Content} = \frac{M_i - M_f}{M_f} \times 100$$

Where:

M_i = initial, moist mass

M_f = final, dry mass

Example:

$$M_i = 1134.9 \text{ g}$$

$$M_f = 1127.3 \text{ g}$$

$$\text{Moisture Content} = \frac{1134.9 \text{ g} - 1127.3 \text{ g}}{1127.3 \text{ g}} \times 100 = 0.674, \text{ say } 0.67\%$$

Report

- On forms approved by the agency
- Sample ID
- Moisture content to the nearest 0.01 percent

This page intentionally left blank.

ATM 408 Mechanical Analysis of Extracted Aggregate

Following are guidelines for the use of WAQTC FOP for AASHTO T 30 by the State of Alaska DOT&PF.

1. Calculate the minus 75 μm (No. 200) by dividing the sum of the loss from washing plus the mass of the material in the pan by the initial sample weight.
2. When the conditions stated in Procedure step #13, “Check Sum Calculation” are not met, a new portion of the sample shall be tested for Acceptance for both asphalt binder content and gradation in accordance with WAQTC FOPs for AASHTO T 308 and T 30.
3. Report all items noted in report section.
4. ANNEX B – use only the values from TABLE B-1 to determine sieve overloading.

This page intentionally left blank.

MECHANICAL ANALYSIS OF EXTRACTED AGGREGATE FOP FOR AASHTO T 30

Scope

This procedure covers mechanical analysis of aggregate recovered from asphalt mix samples in accordance with AASHTO T 30-21. This FOP uses the aggregate recovered from the ignition furnace used in AASHTO T 308. AASHTO T 30 was developed for analysis of extracted aggregate and thus includes references to extracted bitumen and filter element, which do not apply in this FOP.

Sieve analyses determine the gradation or distribution of aggregate particles within a given sample to determine compliance with design and production standards.

Apparatus

- Balance or scale: Capacity sufficient for the sample mass, accurate to 0.1 percent of the sample mass or readable to 0.1 g and conforming to AASHTO M 231.
- Sieves, meeting the requirements of FOP for AASHTO T 27/T 11.
- Mechanical sieve shaker, meeting the requirements of FOP for AASHTO T 27/T 11.
- Mechanical Washing Apparatus (optional).
- Suitable drying equipment, meeting the requirements of the FOP for AASHTO T 255.
- Containers and utensils: A pan or vessel of a size sufficient to contain the sample covered with water and to permit vigorous agitation without loss of any part of the sample or water.
- Wetting Agent: Any dispersing agent, such as dishwashing detergent, that will promote separation of the fine materials.

Sample Sieving

- In this procedure, it is required to shake the sample over nested sieves. Sieves are selected to furnish information required by specification. Intermediate sieves are added for additional information or to avoid overloading sieves, or both.
- The sieves are nested in order of increasing size from the bottom to the top, and the test sample, or a portion of the test sample, is placed on the top sieve.
- The loaded sieves are shaken in a mechanical shaker for approximately 10 minutes, refer to Annex A; *Time Evaluation*.

Mass Verification

The aggregate sample mass, $M_{(T30)}$, determined in this method, shall agree with the mass of the aggregate remaining after ignition, M_f from the FOP for AASTHO T 308, within 0.10 percent. If the variation exceeds 0.10 percent, the results cannot be used for acceptance.

Procedure

1. Determine and record the mass of the sample that was removed from the basket in the FOP for AASHTO T 308 to 0.1 g. Designate this mass as $M_{(T30)}$.
2. Verify the mass of the sample is within 0.10 percent by subtracting $M_{(T30)}$ from $M_{f(T308)}$ dividing by $M_{f(T308)}$ and multiply by 100 (see *Mass Verification Calculation* and example).

If the variation exceeds 0.10 percent, the sieve analysis results cannot be used for acceptance.

3. Nest a sieve, such as a 2.0 mm (No. 10) or 1.18 mm (No. 16), above the 75 μ m (No. 200) sieve.
4. Place the test sample in a container and cover with water. Add a **wetting agent** to the water to assure a thorough separation of the material finer than the 75 μ m (No. 200) sieve from the coarser particles. There should be enough wetting agent to produce a small amount of suds when the sample is agitated. Excessive suds may overflow the sieves and carry material away with them.
5. Agitate vigorously to ensure complete separation of the material finer than 75 μ m (No. 200) from coarser particles and bring the fine material into suspension above the coarser material. Avoid degradation of the sample when using a mechanical washing device. Maximum agitation is 10 min.

Note 1: When mechanical washing equipment is used, the introduction of water, agitating, and decanting may be a continuous operation. Use care not to overflow or overload the 75 μ m (No. 200) sieve.

6. Immediately pour the wash water containing the suspended material over the nested sieves; be careful not to pour out the coarser particles or over fill the 75 μ m (No. 200) sieve.
7. Add water to cover material remaining in the container, agitate, and repeat Step **6**. Continue until the wash water is reasonably clear.
8. Remove the upper sieve, return material retained to the washed sample.
9. Rinse the material retained on the 75 μ m (No. 200) sieve until water passing through the sieve is reasonably clear and wetting agent is removed.
10. Return all material retained on the 75 μ m (No. 200) sieve to the washed sample by rinsing into the washed sample.
11. Dry the washed test sample to constant mass according to the FOP for AASHTO T 255. Cool to room temperature. Determine and record the “dry mass after washing.”
12. Select sieves required by the specification and those necessary to avoid overloading. **(See Annex B.)** With a pan on bottom, nest the sieves increasing in size starting with the 75 μ m (No. 200).
13. Place the test sample, or a portion of the test sample, on the top sieve. Place sieves in mechanical shaker and shake for the minimum time determined to provide complete separation for the sieve shaker being used (approximately 10 minutes, the time determined by Annex A).

Note 2: Excessive shaking (more than 10 minutes) may result in degradation of the sample.

14. Determine and record the individual or cumulative mass retained for each sieve including the pan. Ensure that all material trapped in full openings of the sieves are removed and included in the mass retained.

Note 3: For sieves 4.75 mm (No. 4) and larger, check material trapped in less than a full opening by sieving over a full opening. Use coarse wire brushes to clean the 600 μ m (No. 30) and larger sieves, and soft bristle brushes for smaller sieves.

15. Perform the *Check Sum* calculation – Verify the *total mass after sieving* of material **compared to** the *dry mass after washing* **is not more than** 0.2 percent. Do not use test results for acceptance if the *Check Sum* result is more than 0.2 percent.
16. Calculate the total percentages passing, and the individual or cumulative percentages retained, to the nearest 0.1 percent by dividing the individual sieve masses or cumulative sieve masses by the total mass of the initial dry sample.
17. Apply the Aggregate Correction Factor (ACF) to the calculated percent passing, as required in the FOP for AASHTO T 308 “Correction Factor,” to obtain the reported percent passing.

18. Report total percent passing to 1 percent except report the 75 µm (No. 200) sieve to 0.1 percent.

Calculations

Mass verification

$$\text{Mass verification} = \frac{M_{f(T308)} - M_{(T30)}}{M_{f(T308)}} \times 100$$

Where:

$M_{f(T308)}$ = Mass of aggregate remaining after ignition from the FOP for AASHTO T 308

$M_{(T30)}$ = Mass of aggregate sample obtained from the FOP for AASHTO T 308

Check Sum

$$\text{check sum} = \frac{\text{dry mass after washing} - \text{total mass after sieving}}{\text{dry mass after washing}} \times 100$$

Percent Retained

Individual

$$\text{IPR} = \frac{\text{IMR}}{M_{T30}} \times 100$$

Cumulative

$$\text{CPR} = \frac{\text{CMR}}{M_{T30}} \times 100$$

Where:

IPR = Individual Percent Retained

CPR = Cumulative Percent Retained

M_{T30} = Total dry sample mass before washing

IMR = Individual Mass Retained

CMR = Cumulative Mass Retained

Percent Passing

Individual

$$PP = PCP - IPR$$

Cumulative

$$PP = 100 - CPR$$

Where:

PP = Calculated Percent Passing

PCP = Previous Calculated Percent Passing

Reported Percent Passing

$$RPP = PP + ACF$$

Where:

RPP = Reported Percent Passing
ACF = Aggregate Correction Factor (if applicable)

Example

Mass verification

$$\text{Mass verification} = \frac{2422.5 \text{ g} - 2422.3 \text{ g}}{2422.5 \text{ g}} \times 100 = 0.01\%$$

Given:

$$M_{(T308)} = 2422.5 \text{ g}$$

$$M_{(T30)} = 2422.3 \text{ g}$$

Dry mass of total sample, before washing (M_{T30}): 2422.3 g

Dry mass of sample, after washing out the 75 μm (No. 200) minus: 2296.2 g

Amount of 75 μm (No. 200) minus washed out ($2422.3 \text{ g} - 2296.2 \text{ g}$): 126.1 g

Check sum

$$\text{check sum} = \frac{2296.2 \text{ g} - 2295.3 \text{ g}}{2296.2 \text{ g}} \times 100 = 0.0\%$$

This is not more than 0.2 percent therefore the results can be used for acceptance purposes.

Percent Retained for the 75 μm (No. 200) sieve

$$\text{IPR} = \frac{63.5 \text{ g}}{2422.3 \text{ g}} \times 100 = 2.6\%$$

or

$$\text{CPR} = \frac{2289.6 \text{ g}}{2422.3 \text{ g}} \times 100 = 94.5\%$$

Percent Passing using IPR and PCP for the 75 μm (No. 200) sieve

$$\text{PP} = 8.1\% - 2.6\% = 5.5\%$$

Percent Passing using CPR for the 75 μm (No. 200) sieve

$$\text{PP} = 100.0\% - 94.5\% = 5.5\%$$

Reported Percent Passing

$$\text{RPP} = 5.5\% + (-0.6\%) = 4.9\%$$

Individual Gradation on All Sieves

Sieve Size mm (in.)	Individual Mass Retained g (IMR)	Determine IPR by dividing IMR by <i>M</i> and multiplying by 100	Individual Percent Retained (IPR)	Determine PP by subtracting IPR from Previous PP	Percent Passing (PP)	Agg. Corr. Factor from T 308 (ACF)	Reported Percent Passing*
19.0 (3/4)	0		0		100.0		100
12.5 (1/2)	346.9	$\frac{346.9}{2422.3} \times 100 =$	14.3	$100.0 - 14.3 =$	85.7		86
9.5 (3/8)	207.8	$\frac{207.8}{2422.3} \times 100 =$	8.6	$85.7 - 8.6 =$	77.1		77
4.75 (No. 4)	625.4	$\frac{625.4}{2422.3} \times 100 =$	25.8	$77.1 - 25.8 =$	51.3		51
2.36 (No. 8)	416.2	$\frac{416.2}{2422.3} \times 100 =$	17.2	$51.3 - 17.2 =$	34.1		34
1.18 (No. 16)	274.2	$\frac{274.2}{2422.3} \times 100 =$	11.3	$34.1 - 11.3 =$	22.8		23
0.600 (No. 30)	152.1	$\frac{152.1}{2422.3} \times 100 =$	6.3	$22.8 - 6.3 =$	16.5		17
0.300 (No. 50)	107.1	$\frac{107.1}{2422.3} \times 100 =$	4.4	$16.5 - 4.4 =$	12.1		12
0.150 (No. 100)	96.4	$\frac{96.4}{2422.3} \times 100 =$	4.0	$12.1 - 4.0 =$	8.1		8
0.075 (No. 200)	63.5	$\frac{63.5}{2422.3} \times 100 =$	2.6	$8.1 - 2.6 =$	5.5	-0.6 (5.5 - 0.6 =)	4.9
minus 75 μ m (No. 200) in the pan	5.7						
Total mass after sieving = sum of sieves + mass in the pan = 2295.3 g							
Dry mass of total sample, before washing (M_{T30}): 2422.3g							

* Report total percent passing to 1 percent except report the 75 μ m (No. 200) sieve to 0.1 percent.

Cumulative Gradation on All Sieves

Sieve Size mm (in.)	Cumulative Mass Retained g (CMR)	Determine CPR by dividing CMR by M and multiplying by 100	Cumulative Percent Retained (CPR)	Determine PP by subtracting CPR from 100.0	Percent Passing (PP)	Agg. Corr. Factor from T 308 (ACF)	Reported Percent Passing*
19.0 (3/4)	0		0.0		100.0		100
12.5 (1/2)	346.9	$\frac{346.9}{2422.3} \times 100 =$	14.3	$100.0 - 14.3$	85.7		86
9.5 (3/8)	554.7	$\frac{554.7}{2422.3} \times 100 =$	22.9	$100.0 - 22.9$	77.1		77
4.75 (No. 4)	1180.1	$\frac{1180.1}{2422.3} \times 100 =$	48.7	$100.0 - 48.7$	51.3		51
2.36 (No. 8)	1596.3	$\frac{1596.3}{2422.3} \times 100 =$	65.9	$100.0 - 65.9$	34.1		34
1.18 (No. 16)	1870.5	$\frac{1870.5}{2422.3} \times 100 =$	77.2	$100.0 - 77.2$	22.8		23
0.600 (No. 30)	2022.6	$\frac{2022.6}{2422.3} \times 100 =$	83.5	$100.0 - 83.5$	16.5		17
0.300 (No. 50)	2129.7	$\frac{2129.7}{2422.3} \times 100 =$	87.9	$100.0 - 87.9$	12.1		12
0.150 (No. 100)	2226.1	$\frac{2226.1}{2422.3} \times 100 =$	91.9	$100.0 - 91.9$	8.1		8
0.075 (No. 200)	2289.6	$\frac{2289.6}{2422.3} \times 100 =$	94.5	$100.0 - 94.5$	5.5	-0.6 (5.5 - 0.6 =)	4.9
minus 75 μ m (No. 200) in the pan	2295.3						
Total mass after sieving = 2295.3 g							
Dry mass of total sample, before washing (M _{T30}): 2422.3g							

* Report total percent passing to 1 percent except report the 75 μ m (No. 200) sieve to 0.1 percent.

Report

- On forms approved by the agency
- Sample ID
- Depending on the agency, this may include:

- Individual mass retained on each sieve
- Individual percent retained on each sieve
- Cumulative mass retained on each sieve
- Cumulative percent retained on each sieve
- Aggregate Correction Factor for each sieve from AASHTO T 308
- Calculated percent passing each sieve to 0.1 percent
- Percent passing to the nearest 1 percent, except 75 μm (No. 200) sieve to the nearest 0.1 percent.

ANNEX A TIME EVALUATION

(Mandatory Information)

The minimum time requirement should be evaluated for each shaker at least annually by the following method:

- Shake the sample over nested sieves for approximately 10 minutes.
- Provide a snug-fitting pan and cover for each sieve and hold in a slightly inclined position in one hand.
- Hand-shake each sieve by striking the side of the sieve sharply and with an upward motion against the heel of the other hand at the rate of about 150 times per minute, turning the sieve about one sixth of a revolution at intervals of about 25 strokes.

If more than 0.5 percent by mass of the total sample before sieving passes any sieve after one minute of continuous hand sieving adjust shaker time and re-check.

In determining sieving time for sieve sizes larger than 4.75 mm (No. 4), limit the material on the sieve to a single layer of particles.

ANNEX B OVERLOAD DETERMINATION

(Mandatory Information)

- For sieves with openings smaller than 4.75 mm (No. 4), the mass retained on any sieve shall not exceed 7 kg/m² (4 g/in²) of sieving surface.
- For sieves with openings 4.75 mm (No. 4) and larger, the mass (in kg) shall not exceed the product of 2.5 x (sieve opening in mm) x (effective sieving area). See Table B1.

Additional sieves may be necessary to keep from overloading the specified sieves. The sample may also be sieved in increments or sieves with a larger surface area.

TABLE B1
Maximum Allowable Mass of Material Retained on a Sieve, g
Nominal Sieve Size, mm (in.)
Exact size is smaller (see AASHTO T 27)

Sieve Size mm (in.)		203 mm	254 mm	305 mm
		(8 in.) dia.	(10 in.) dia.	(12 in.) dia.
		Sieving Area m² (in²)		
		0.0285 (44.2)	0.0457 (70.8)	0.0670 (103.5)
50	(2)	3600	5700	8400
37.5	(1 1/2)	2700	4300	6300
25.0	(1)	1800	2900	4200
19.0	(3/4)	1400	2200	3200
16.0	(5/8)	1100	1800	2700
12.5	(1/2)	890	1400	2100
9.5	(3/8)	670	1100	1600
6.3	(1/4)	440	720	1100
4.75	(No. 4)	330	540	800
-4.75	(-No. 4)	200	320	470

This page intentionally left blank.

ATM 409 THEORETICAL MAXIMUM SPECIFIC GRAVITY (G_{mm}) AND DENSITY OF ASPHALT MIXTURES

Following are guidelines for the use of WAQTC FOP for AASHTO T 209 by the State of Alaska DOT&PF.

1. Delete Table 1 and replace with the Table 3

Table 3
Test Sample Size for Maximum Specific Gravity

Nominal Maximum Aggregate Size*		Minimum Mass
mm	(in.)	g
25	(1)	2500
19	(3/4)	2000
12.5	(1/2)	1500
9.5	(3/8)	1000
4.75	(No. 4)	500

* One sieve larger than the first sieve to retain more than 10 percent of the material using an agency specified set of sieves based on cumulative percent retained. Where large gaps in specification sieves exist, intermediate sieve(s) may be inserted to determine nominal maximum.

2. Density Correction for temperature variation is discontinued.

This page intentionally left blank.

THEORETICAL MAXIMUM SPECIFIC GRAVITY (GMM) AND DENSITY OF ASPHALT MIXTURES

FOP FOR AASHTO T 209

Scope

This procedure covers the determination of the maximum specific gravity (G_{mm}) of uncompacted asphalt mixtures in accordance with AASHTO T 209-22. Two methods using different containers – bowl and pycnometer / volumetric flask– are covered.

Specimens prepared in the laboratory shall be cured according to agency standards.

Apparatus

- Balance or scale: 10,000 g capacity, readable to 0.1 g, meeting AASHTO M 231, Class G2
- Container: A glass, metal, or plastic bowl, pycnometer or volumetric flask between 2000 and 10,000 mL as required by the minimum sample size requirements in Table 1 sample and capable of withstanding full vacuum applied
- Pycnometer / volumetric flask cover: A glass plate or a metal or plastic cover with a vented opening
- Vacuum lid: A transparent lid with a suitable vacuum connection, with a vacuum opening to be covered with a fine wire mesh
- Vacuum pump or water aspirator: Capable of evacuating air from the container to a residual pressure of 3.4 kPa (25 mm Hg)
- Vacuum measurement device: Residual pressure manometer or vacuum gauge, capable of measuring residual pressure down to 3.4 kPa (25 mm Hg) or less and accurate to 0.1 kPa (1 mm Hg)
- Manometer or vacuum gauge: Capable of measuring the vacuum being applied at the source of the vacuum
- Water bath: A constant-temperature water bath (optional for Pycnometer or Volumetric Flask Method)
- Thermometers: Thermometric devices accurate to 0.25°C (0.5°F) and with a temperature range of at least 20 to 45°C (68 to 113°F).
- Bleeder valve to adjust vacuum
- Automatic vacuum control unit (optional)
- Timer
- Towel

Standardization

Use a container that has been standardized according to Annex A. The container shall be standardized periodically in conformance with procedures established by the agency.

Test Sample Preparation

1. Obtain samples in accordance with the FOP for AASHTO R 97 and reduce according to the FOP for AASHTO R 47.
2. Test sample size shall conform to the requirements of Table 1. Samples larger than the capacity of the container may be tested in two or more increments. Results will be combined by calculating the weighted

average ($G_{mm(avg)}$). If the increments have a specific gravity difference **greater than 0.013**, the test must be re-run.

- Plant-produced samples may be short-term conditioned according to AASHTO R 30 as specified by the agency.

Note 1: Short-term conditioning at the specified temperature is especially important when absorptive aggregates are used. This short-term conditioning will ensure the computation of realistic values for the amount of asphalt absorbed by the aggregate and void properties of the mix. Plant-produced asphalt mixtures should be evaluated to make sure short-term conditioning has taken place during production and delivery.

Table 1
Test Sample Size for G_{mm}

Nominal Maximum* Aggregate Size mm (in.)	Minimum Mass g
37.5 or greater (1½)	4000
19 to 25 (¾ to 1)	2500
12.5 or smaller (½)	1500

*Nominal maximum size: One sieve larger than the first sieve to retain more than 10 percent of the material using an agency specified set of sieves based on cumulative percent retained.

Procedure – General

Two procedures – bowl and pycnometer / volumetric flask – are covered. The first 11 steps are the same for both.

- Separate the particles of the sample, taking care not to fracture the mineral particles, so that the particles of the fine aggregate portion are not larger than 6.3 mm (¼ in.). If the mixture is not sufficiently soft to be separated manually, place it in a large flat pan and warm in an oven only until it is pliable enough for separation.
- Cool the sample to room temperature.
- Determine and record the mass of the dry container to the nearest 0.1 g.
- Place the sample in the container.
- Determine and record the mass of the dry container and sample to the nearest 0.1 g.
- Determine and record the mass of the sample by subtracting the mass determined in Step 3 from the mass determined in Step 5. Designate this mass as “A.”
- Add sufficient water at approximately 25° C (77° F) to cover the sample by about 25 mm (1 in.).

Note 2: The release of entrapped air may be facilitated by the addition of a wetting agent. Check with the agency to see if this is permitted and, if it is, for a recommended agent.

- Place the lid on the container and attach the vacuum line. To ensure a proper seal between the container and the lid, wet the O-ring or use a petroleum gel.
- Remove entrapped air by subjecting **the sample** to a partial vacuum of 3.7 ± 0.3 kPa (27.5 ± 2.5 mm Hg) residual pressure for **15 ± 1 minutes**.
- Agitate the container and **sample**, either continuously by mechanical device or manually by vigorous **shaking** at 2-minute intervals. This agitation facilitates the removal of air.

11. Release the vacuum. Increase the pressure to atmospheric pressure in 10 to 15 seconds if the vacuum release is not automated. Turn off the vacuum pump and remove the lid. When performing the pycnometer / volumetric flask method, complete steps 12B through 16B within 10 ± 1 minute.

Procedure – Bowl

- 12A. Fill the water bath to overflow level with water at $25 \pm 1^\circ\text{C}$ ($77 \pm 2^\circ\text{F}$) and allow the water to stabilize.
- 13A. Zero or tare the balance with the immersion apparatus attached, ensuring that the device is not touching the sides or the bottom of the water bath.
- 14A. Suspend and immerse the bowl and sample in water at $25 \pm 1^\circ\text{C}$ ($77 \pm 2^\circ\text{F}$) for 10 ± 1 minute. The holder shall be immersed sufficiently to cover both it and the bowl.
- 15A. Determine and record the submerged weight of the bowl and sample to the nearest 0.1 g. Designate as “C.”

Procedure – Pycnometer or Volumetric Flask

- 12B. Immediately fill the pycnometer / volumetric flask with water without reintroducing air.
- 13B. Stabilize the temperature of the pycnometer / volumetric flask and sample so that the final temperature is within $25 \pm 1^\circ\text{C}$ ($77 \pm 2^\circ\text{F}$).
- 14B. Finish filling the pycnometer / volumetric flask with water that is $25 \pm 1^\circ\text{C}$ ($77 \pm 2^\circ\text{F}$), place the cover or a glass plate on the pycnometer / volumetric flask, and eliminate all air.

Note 3: When using a metal pycnometer and cover, place the cover on the pycnometer and push down slowly, forcing excess water out of the hole in the center of the cover. Use care when filling the pycnometer to avoid reintroducing air into the water.

- 15B. Towel dry the outside of the pycnometer / volumetric flask and cover.
- 16B. Determine and record the mass of the pycnometer / volumetric flask, cover, de-aired water, and sample to the nearest 0.1 g. within 10 ± 1 minute of completion of Step 11. Designate this mass as “E.”

Procedure – Mixtures Containing Uncoated Porous Aggregate

If the pores of the aggregates are not thoroughly sealed by a bituminous film, they may become saturated with water during the vacuuming procedure, resulting in an error in maximum density. To determine if this has occurred, complete the general procedure and then:

1. Carefully drain water from sample through a towel held over the top of the container to prevent loss of material.
2. Spread sample in a flat shallow pan and place before an electric fan to remove surface moisture.
3. Determine the mass of the sample when the surface moisture appears to be gone.
4. Continue drying and determine the mass of the sample at 15-minute intervals until less than a 0.5 g loss is found between determinations.
5. Record the mass as the saturated surface dry mass to the nearest 0.1 g. Designate this mass as “A_{SSD}.”
6. Calculate, as indicated below, G_{mm} using “A” and “A_{SSD},” and compare the two values.

Calculation

Calculate the G_{mm} to three decimal places as follows:

Bowl Procedure

$$G_{mm} = \frac{A}{A + B - C} \quad \text{or} \quad G_{mm} = \frac{A}{A_{SSD} + B - C}$$

(for mixes containing uncoated aggregate materials)

Where:

- A = mass of dry sample in air, g
- A_{SSD} = mass of saturated surface dry sample in air, g
- B = standardized submerged weight of the bowl, g (see Annex A)
- C = submerged weight of sample and bowl, g

Example:

$$G_{mm} = \frac{1432.7 \text{ g}}{1432.7 \text{ g} + 286.3 \text{ g} - 1134.9 \text{ g}} = 2.453 \quad \text{or}$$

$$G_{mm} = \frac{1432.7 \text{ g}}{1434.2 \text{ g} + 286.3 \text{ g} - 1134.9 \text{ g}} = 2.447$$

Given:

- A = 1432.7 g
- A_{SSD} = 1434.2 g
- B = 286.3 g
- C = 1134.9 g

Pycnometer / Volumetric Flask Procedure

$$G_{mm} = \frac{A}{A + D - E} \quad \text{or} \quad G_{mm} = \frac{A}{A_{SSD} + D - E}$$

(for mixtures containing uncoated materials)

Where:

- A = mass of dry sample in air, g
- A_{SSD} = mass of saturated surface-dry sample in air, g
- D = standardized mass of pycnometer / volumetric flask filled with water at 25°C (77°F), g, (See Annex A)
- E = mass of pycnometer / volumetric flask filled with water and the test sample at test temperature, g

Example (two increments of a large sample):

$$G_{mm_1} = \frac{2200.3 \text{ g}}{2200.3 \text{ g} + 7502.5 \text{ g} - 8812.0 \text{ g}} = 2.470$$

$$G_{mm_2} = \frac{1960.2 \text{ g}}{1960.2 \text{ g} + 7525.5 \text{ g} - 8690.8 \text{ g}} = 2.466$$

Given:

- | | |
|---------------------------|---------------------------|
| Increment 1 | Increment 2 |
| A ₁ = 2200.3 g | A ₂ = 1960.2 g |
| D ₁ = 7502.5 g | D ₂ = 7525.5 g |
| E ₁ = 8812.0 g | E ₂ = 8690.8 g |

Variation = 2.470 - 2.466 = 0.004, which is < 0.013

Allowable variation is: 0.013. The values may be used.

Weighted average

For large samples tested a portion at a time, calculate the $G_{mm(avg)}$ by multiplying the dry mass of each increment by its G_{mm} , add the results together (Σ) and divide by the sum (Σ) of the dry masses.

$$G_{mm(avg)} = \frac{\Sigma(A_x \times G_{mmx})}{\Sigma A_x}$$

or

$$G_{mm(avg)} = \frac{(A_1 \times G_{mm1}) + (A_2 \times G_{mm2})}{A_1 + A_2} \text{ etc.}$$

Where:

A_x = mass of dry sample increment in air, g

G_{mmx} = theoretical maximum specific gravity of the increment

Example:

$$G_{mm(avg)} = \frac{(2200.3 \text{ g} \times 2.470) + (1960.2 \text{ g} \times 2.466)}{2200.3 \text{ g} + 1960.2 \text{ g}} = \frac{10,268.6}{4160.5 \text{ g}} = 2.468$$

Theoretical Maximum Density

To calculate the theoretical maximum density at 25°C (77°F) use one of the following formulas. The density of water at 25°C (77°F) is 997.1 kg/m³ in Metric units or 62.245 lb/ft³ in English units.

Theoretical maximum density kg/m³ = $G_{mm} \times 997.1 \text{ kg/m}^3$

$2.468 \times 997.1 \text{ kg/m}^3 = 2461 \text{ kg/m}^3$

or

Theoretical maximum density lb/ft³ = $G_{mm} \times 62.245 \text{ lb/ft}^3$

$2.468 \times 62.245 \text{ lb/ft}^3 = 153.6 \text{ lb/ft}^3$

Report

- On forms approved by the agency
- Sample ID
- G_{mm} to the nearest 0.001
- Theoretical maximum density to the nearest 1 kg/m³ (0.1 lb/ft³)

ANNEX A – STANDARDIZATION OF BOWL AND PYCNOMETER OR VOLUMETRIC FLASK

(Mandatory Information)

Bowl – Standardization

1. Fill the water bath to overflow level with $25 \pm 1^{\circ}\text{C}$ ($77 \pm 2^{\circ}\text{F}$) water and allow the water to stabilize.
2. Zero or tare the balance with the immersion apparatus attached, ensuring that the device is not touching the sides or the bottom of the water bath.
3. Suspend and completely immerse the bowl for 10 ± 1 minute.
4. Determine and record the submerged weight of the bowl to the nearest 0.1 g.
5. Refill the water bath to overflow level.
6. **Perform** Steps 2 through 5 two more times for a total of three determinations.
7. If the **range of the three determinations is less than or equal to 0.3 g.**, average the determinations. Designate as “B.”
8. If the **range of the** three determinations is greater than 0.3 g., take corrective action and perform the standardization procedure again.

Bowl – Check

1. Fill the water bath to overflow level $25 \pm 1^{\circ}\text{C}$ ($77 \pm 2^{\circ}\text{F}$) water and allow the water to stabilize.
2. Zero or tare the balance with the immersion apparatus attached, ensuring that the device is not touching the sides or the bottom of the water bath.
3. Suspend and completely immerse the bowl for 10 ± 1 minute.
4. Determine and record the submerged weight of the bowl to the nearest 0.1 g.
5. If this determination is within 0.3 g of the standardized value, use the standardized value for “B.”
6. If it is not within 0.3 g, take corrective action and perform the standardization procedure again.
7. **For labs that check the bowl standardization frequently (such as daily), calculate the moving average and range of the last three mass determinations. Designate the average of the last three masses as “B.”**
8. **If the moving range exceeds 0.3 g at any time, take corrective action and perform the standardization procedure again.**

Pycnometer or Volumetric Flask – Standardization

1. Fill the pycnometer / volumetric flask with water at approximately 25°C (77°F).
2. Place the metal or plastic cover, or a glass plate on the pycnometer / volumetric flask and eliminate all air. (See Note 2.)
3. Stabilize the pycnometer / volumetric flask at $25 \pm 1^{\circ}\text{C}$ ($77 \pm 2^{\circ}\text{F}$) for 10 ± 1 min.
4. Towel dry the outside of the pycnometer / volumetric flask and cover.
5. Determine and record the mass of the pycnometer / volumetric flask, water, and lid to the nearest 0.1 g.
6. **Perform** Steps 2 through 5 two more times for a total of three determinations.

7. If the range of the three determinations is less than or equal to 0.3 g, average the three determinations. Designate as “D.”
8. If the range of the determinations is greater than 0.3 g., take corrective action and perform the “Pycnometer or Volumetric Flask – Standardization” again.

Pycnometer or Volumetric Flask – Check

1. Fill the pycnometer / volumetric flask with water at approximately 25°C (77°F).
2. Place the metal or plastic cover or a glass plate on the pycnometer / volumetric flask and eliminate all air. (See Note 2.)
3. Stabilize the pycnometer / volumetric flask at $25 \pm 1^\circ\text{C}$ ($77 \pm 2^\circ\text{F}$) for 10 ± 1 min.
4. Towel dry the outside of the pycnometer / volumetric flask and cover.
5. Determine and record the mass of the pycnometer / volumetric flask, water, and lid.
6. If this determination is within 0.3 g of the standardized value, use the standardized value for “D.”
7. If it is not within 0.3 g, perform the standardization procedure again.

This page intentionally left blank.

ATM 410 Bulk Specific Gravity (G_{mb}) of Compacted Hot Mix Asphalt (HMA) Using Saturated Surface-Dry Specimens

Following are guidelines for the use of WAQTC FOP for AASHTO T 166 by the State of Alaska DOT&PF.

1. Report compaction to the 0.1%. Calculate as follows:

$$C_p = \left(\frac{G_{mb}}{G_{mm}} \right) \times 100$$

Where:

C_p = Percent Compaction

G_{mm} = Theoretical Maximum Specific Gravity G_{mb} = Bulk Specific Gravity

2. Method C/A may be used on DOT&PF projects, regardless of the absorption calculated.
3. For Procedure - Method C, Apparatus and Step 4, change oven requirement to read “at least $110 \pm 5^\circ\text{C}$ ($230 \pm 9^\circ\text{F}$) up to the JMF mixing temperature.”
4. AASHTO T 331, Standard Method of Test for Bulk Specific Gravity (G_{mb}) and Density of Compacted Asphalt Mixtures Using Automatic Vacuum Sealing Method, may be used.
5. As an alternate to drying to constant mass in an oven, ASTM D 7227 may be used.

This page intentionally left blank.

BULK SPECIFIC GRAVITY (G_{MB}) OF COMPACTED ASPHALT MIXTURES USING SATURATED SURFACE-DRY SPECIMENS FOP FOR AASHTO T 166

Scope

This procedure covers the determination of bulk specific gravity (G_{mb}) of compacted asphalt mixtures using three methods – A, B, and C – in accordance with AASHTO T 166-22. This FOP is for use on specimens not having open or interconnecting voids or absorbing more than 2.00 percent water by volume, or both. When specimens have open or interconnecting voids or absorbing more than 2.00 percent water by volume, or both, AASHTO T 275 or AASHTO T 331 should be performed.

Overview

- Method A: Suspension
- Method B: Volumeter
- Method C: Rapid test for A or B

Test Specimens

Test specimens may be either laboratory-molded or sampled from asphalt mixture pavement. For specimens it is recommended that the diameter be equal to four times the maximum size of the aggregate and the thickness be at least one and one half times the maximum size.

Terminology

Constant Mass: The state at which a mass does not change more than a given percent, after additional drying for a defined time interval, at a required temperature.

Apparatus – Method A (Suspension)

- Balance or scale: 5 kg capacity, readable to 0.1 g, and fitted with a suitable suspension apparatus and holder to permit weighing the specimen while suspended in water, conforming to AASHTO M 231.
- Suspension apparatus: Wire of the smallest practical size and constructed to permit the container to be fully immersed.
- Water bath: For immersing the specimen in water while suspended under the balance or scale and equipped with an overflow outlet for maintaining a constant water level and capable of maintaining a uniform temperature at $25 \pm 1^\circ\text{C}$ ($77 \pm 2^\circ\text{F}$).
- Towel: Damp cloth towel used for surface drying specimens.
- Oven: Capable of maintaining a temperature of $52 \pm 3^\circ\text{C}$ ($126 \pm 5^\circ\text{F}$) for drying the specimens to a constant mass.
- Pan: Pan or other suitable container of known mass, large enough to hold a sample for drying in oven.
- Thermometer: Having a range of 15 to 45°C (59 to 113°F) and, graduated in 0.1°C (0.2°F) subdivisions.
- Vacuum device: refer to the FOP for AASHTO R 79 (optional)

Procedure – Method A (Suspension)

Recently molded laboratory samples that have not been exposed to moisture do not need drying.

1. Dry the specimen to constant mass, if required.

- a. Oven method
 - i. Initially dry overnight at $52 \pm 3^{\circ}\text{C}$ ($125 \pm 5^{\circ}\text{F}$).
 - ii. Determine and record the mass of the specimen. Designate this mass as M_p .
 - iii. Return the specimen to the oven for at least 2 hours.
 - iv. Determine and record the mass of the specimen. Designate this mass as M_n .
 - v. Determine percent change by subtracting the new mass determination, M_n , from the previous mass determination, M_p , divide by the previous mass determination M_p , and multiply by 100.
 - vi. Continue drying until there is no more than 0.05 percent change in specimen mass after 2-hour drying intervals (constant mass).
 - vii. Constant mass has been achieved; sample is defined as dry.

Note 1: To expedite the procedure, steps 1 and 2 may be performed last. To further expedite the process, see Method C.

- b. Vacuum dry method according to the FOP for AASHTO R 79.
2. Cool the specimen in air to $25 \pm 5^{\circ}\text{C}$ ($77 \pm 9^{\circ}\text{F}$), and determine and record the dry mass to the nearest 0.1 g. Designate this mass as A.
 3. Fill the water bath to overflow level with water at $25 \pm 1^{\circ}\text{C}$ ($77 \pm 2^{\circ}\text{F}$) and allow the water to stabilize.
 4. Zero or tare the balance with the immersion apparatus attached, ensuring that the device is not touching the sides or the bottom of the water bath.
 5. Immerse the specimen shaking to remove the air bubbles. Place the specimen on its side in the suspension apparatus. Leave it immersed for 4 ± 1 minutes.
 6. Determine and record the submerged weight to the nearest 0.1 g. Designate this submerged weight as C.
 7. Remove the sample from the water and quickly surface dry with a damp cloth towel within 5 seconds.
 8. Zero or tare the balance.
 9. Immediately determine and record the mass of the saturated surface-dry (SSD) specimen to nearest 0.1 g. Designate this mass as B. Any water that seeps from the specimen during the mass determination is considered part of the saturated specimen. Do not to exceed 15 seconds performing Steps 7 through 9.

Calculations – Method A (Suspension)

Constant Mass:

Calculate constant mass using the following formula:

$$\%Change = \frac{M_p - M_n}{M_p} \times 100$$

Where:

M_p = previous mass measurement, g

M_n = new mass measurement, g

Bulk specific gravity (G_{mb}) and percent water absorbed:

$$G_{mb} = \frac{A}{B - C}$$

$$\text{Percent Water Absorbed (by volume)} = \frac{B - A}{B - C} \times 100$$

Where:

G_{mb} = Bulk specific gravity

A = Mass of dry specimen in air, g

B = Mass of SSD specimen in air, g

C = Weight of specimen in water at $25 \pm 1^\circ\text{C}$ ($77 \pm 2^\circ\text{F}$), g

Example:

$$G_{mb} = \frac{4833.6 \text{ g}}{4842.4 \text{ g} - 2881.3 \text{ g}} = 2.465$$

$$\% \text{ Water Absorbed (by volume)} = \frac{4842.4 \text{ g} - 4833.6 \text{ g}}{4842.4 \text{ g} - 2881.3 \text{ g}} \times 100 = 0.45\%$$

Given:

A = 4833.6 g

B = 4842.4 g

C = 2881.3 g

Apparatus – Method B (Volumeter)

- Balance or scale: 5 kg capacity, readable to 0.1 g and conforming to AASHTO M 231.
- Water bath: For immersing the specimen in water, capable of maintaining a uniform temperature at $25 \pm 1^\circ\text{C}$ ($77 \pm 2^\circ\text{F}$).
- Thermometer: Range of 15 to 45°C (59 to 113°F) and graduated in 0.1°C (0.2°F) subdivisions.
- Volumeter: Calibrated to 1200 mL or appropriate capacity for test sample and having a tapered lid with a capillary bore.
- Oven: Capable of maintaining a temperature of $52 \pm 3^\circ\text{C}$ ($126 \pm 5^\circ\text{F}$). for drying the specimens to a constant mass.
- Pan: Pan or other suitable container of known mass, large enough to hold a sample for drying in oven.
- Towel: Damp cloth towel used for surface drying specimens.
- Vacuum device: refer to the FOP for AASHTO R 79 (optional)

Procedure – Method B (Volumeter)

Recently molded laboratory samples that have not been exposed to moisture do not need drying.

1. Dry the specimen to constant mass, if required.
 - a. Oven method:
 - i. Initially dry overnight at $52 \pm 3^\circ\text{C}$ ($125 \pm 5^\circ\text{F}$).
 - ii. Determine and record the mass of the specimen. Designate this mass as M_p .

- iii. Return the specimen to the oven for at least 2 hours.
- iv. Determine and record the mass of the specimen. Designate this mass as M_n .
- v. Determine percent change by subtracting the new mass determination, M_n , from the previous mass determination, M_p , divide by the previous mass determination, M_p , and multiply by 100.
- vi. Continue drying until there is no more than 0.05 percent change in specimen mass after 2-hour drying intervals (constant mass).
- vii. Constant mass has been achieved; sample is defined as dry.

Note 1: To expedite the procedure, steps 1 and 2 may be performed last. To further expedite the process, see Method C.

b. Vacuum dry method according to the FOP for AASHTO R 79.

2. Cool the specimen in air to $25 \pm 5^\circ\text{C}$ ($77 \pm 9^\circ\text{F}$), and determine and record the dry mass to the nearest 0.1 g. Designate this mass as A.
3. Immerse the specimen in the temperature-controlled water bath at $25 \pm 1^\circ\text{C}$ ($77 \pm 2^\circ\text{F}$) for at least 10 minutes.
4. At the end of the ten-minute period, fill the volumeter with distilled water at $25 \pm 1^\circ\text{C}$ ($77 \pm 2^\circ\text{F}$) making sure some water escapes through the capillary bore of the tapered lid.
5. Wipe the volumeter dry. Determine the mass of the volumeter and water to the nearest 0.1 g. Designate this mass as D.
6. Remove the specimen from the water bath and quickly surface dry with a damp cloth towel within 5 seconds.
7. Immediately determine and record the mass of the SSD specimen to the nearest 0.1 g. Designate this mass as B. Any water that seeps from the specimen during the mass determination is considered part of the saturated specimen.
8. Place the specimen in the volumeter and let stand 60 seconds.
9. Bring the temperature of the water to $25 \pm 1^\circ\text{C}$ ($77 \pm 2^\circ\text{F}$) and cover the volumeter, making sure some water escapes through the capillary bore of the tapered lid.
10. Wipe the volumeter dry.
11. Determine and record the mass of the volumeter, water, and specimen to the nearest 0.1 g. Designate this mass as E.

Note 2: Method B is not acceptable for use with specimens that have more than 6 percent air voids.

Calculations – Method B (Volumeter)

Constant Mass:

Calculate constant mass using the following formula:

$$\%Change = \frac{M_p - M_n}{M_p} \times 100$$

Where:

M_p = previous mass measurement, g

M_n = new mass measurement, g

Bulk specific gravity (G_{mb}) and percent water absorbed:

$$G_{mb} = \frac{A}{B + D - E}$$

$$\text{Percent Water Absorbed (by volume)} = \frac{B - A}{B + D - E} \times 100$$

Where:

- G_{mb} = Bulk specific gravity
- A = Mass of dry specimen in air, g
- B = Mass of SSD specimen in air, g
- D = Mass of volumeter filled with water at $25 \pm 1^\circ\text{C}$ ($77 \pm 2^\circ\text{F}$), g
- E = Mass of volumeter filled with specimen and water, g

Example:

$$G_{mb} = \frac{4833.6 \text{ g}}{4842.4 \text{ g} + 2924.4 \text{ g} - 5806.0 \text{ g}} = 2.465$$

$$\% \text{ Water Absorbed (by volume)} = \frac{4842.4 \text{ g} - 4833.6 \text{ g}}{4842.4 \text{ g} + 2924.4 \text{ g} - 5806.0 \text{ g}} \times 100 = 0.45\%$$

Given:

- A = 4833.6 g
- B = 4842.4 g
- D = 2924.4 g
- E = 5806.0 g

Apparatus – Method C (Rapid Test for Method A or B)

Oven: Capable of maintaining a temperature of $110 \pm 5^\circ\text{C}$ ($230 \pm 9^\circ\text{F}$) for drying the specimens to a constant mass. [See note #3, Guidance Page]

See Methods A or B.

Note 3: This procedure can be used for specimens that are not required to be saved and contain substantial amounts of moisture. Cores can be tested the same day as obtained by this method.

Procedure – Method C (Rapid Test for Method A or B)

1. Start on Step 3 of Method A or B, and complete that procedure, then determine dry mass, A, as follows.
2. Determine and record mass of a large, flat-bottom container.
3. Place the specimen in the container.
4. Place in an oven at $110 \pm 5 \text{ C}$ ($230 \pm 9 \text{ F}$). [see note #3, Guidance Page]
5. Dry until the specimen can be easily separated into fine aggregate particles that are not larger than 6.3 mm ($\frac{1}{4}$ in.).
6. Determine and record the mass of the specimen. Designate this mass as M_p .
7. Return the specimen to the oven for at least 2 hours.
8. Determine and record the mass of the specimen. Designate this mass as M_n .

9. Determine percent change by subtracting the new mass determination, M_n , from the previous mass determination, M_p , divide by the previous mass determination, M_p , and multiply by 100.
10. Continue drying until there is no more than 0.05 percent change in specimen mass after 2-hour drying intervals (constant mass).
11. Constant mass has been achieved; sample is defined as dry.
12. Cool in air to $25 \pm 5^\circ\text{C}$ ($77 \pm 9^\circ\text{F}$).
13. Determine and record the mass of the container and dry specimen to the nearest 0.1 g.
14. Determine and record the mass of the dry specimen to the nearest 0.1 g by subtracting the mass of the container from the mass determined in Step 13. Designate this mass as A.

Calculations – Method C (Rapid Test for Method A or B)

Complete the calculations as outlined in Methods A or B, as appropriate.

Report

- On forms approved by the agency
- Sample ID
- G_{mb} to the nearest 0.001
- Absorption to the nearest 0.01 percent
- Method performed.

ATM 411 In-Place Density of Asphalt Mixtures By Nuclear Method

FOP For AASHTO T 355

Following are guidelines for the use of WAQTC FOP for AASHTO T 355 by the State of Alaska DOT&PF. Replaces WAQTC TM 8.

1. Testing under this method shall be used for quality control and when specified, acceptance testing.
2. Report percent compaction to the nearest 0.1 percent. Report percent air voids, if required.
3. Any offsets determined are GAUGE-SPECIFIC and must be determined for each gauge used to test the material.
4. When The Standard Density is determined using ATM 412, use the average of the tests performed according to ATM 411 (See ATM 412 Worksheets), taken at three separate random test locations, as the acceptance test value.
5. Direct transmission may be used on crushed asphalt materials.

For direct Transmission use the following procedure:

Procedure

Direct Transmission

1. Maximum contact between the base of the gauge and the surface of the material under test is critical.
2. Use the guide and scraper plate as a template and drill a hole to a depth of at least 7 mm (1/4 in.) deeper than the measurement depth required for the gauge.
3. Place the gauge on the prepared surface so the source rod can enter the hole. Insert the probe in the hole and lower the source rod to the desired test depth using the handle and trigger mechanism. Position the gauge with the long axis of the gauge parallel to the direction of paving. Pull the gauge so that the probe is firmly against the side of the hole.
4. Take one four-minute test and record the wet density (WD) reading.

This page intentionally left blank.

IN-PLACE DENSITY OF ASPHALT MIXTURES BY NUCLEAR METHODS FOP FOR AASHTO T 355

Scope

This test method describes a procedure for determining the density of asphalt mixtures by means of a nuclear gauge using the backscatter method in accordance with AASHTO

T 355-22. Correlation with densities determined under the FOP for AASHTO T 166 is required by some agencies.

Apparatus

- Nuclear density gauge with the factory-matched standard reference block.
- Transport case for properly shipping and housing the gauge and tools.
- Instruction manual for the specific make and model of gauge.
- Radioactive materials information and calibration packet containing:
 - Daily standard count log
 - Factory and laboratory calibration data sheet
 - Leak test certificate
 - Shippers' declaration for dangerous goods
 - Procedure memo for storing, transporting, and handling nuclear testing equipment
 - Other radioactive materials documentation as required by local regulatory requirements

Material

Filler material: Fine-graded sand from the source used to produce the asphalt pavement or other agency approved materials.

Radiation Safety

This method does not purport to address all of the safety problems associated with its use. This test method involves potentially hazardous materials. The gauge utilizes radioactive materials that may be hazardous to the health of the user unless proper precautions are taken. Users of this gauge must become familiar with the applicable safety procedures and governmental regulations. All operators will be trained in radiation safety before operating nuclear density gauges. Some agencies require the use of personal monitoring devices such as a thermoluminescent dosimeter or film badge. Effective instructions, together with routine safety procedures such as source leak tests, recording and evaluation of personal monitoring device data, etc., are a recommended part of the operation and storage of this gauge.

Calibration

Calibrate the nuclear gauge as required by the agency. This calibration may be performed by the agency using the manufacturer's recommended procedures or by other facilities approved by the agency. Verify or re-establish calibration curves, tables, or equivalent coefficients every 12 months.

Standardization

1. Turn the gauge on and allow it to stabilize (approximately 10 to 20 minutes) before standardization. Leave the power on during the day's testing.

2. Standardize the nuclear gauge at the construction site at the start of each day's work and as often as deemed necessary by the operator or agency. Daily variations in standard count shall not exceed the daily variations established by the manufacturer of the gauge. If the daily variations are exceeded after repeating the standardization procedure, the gauge should be repaired, recalibrated, or both.
3. Record the standard count for both density and moisture in the daily standard count log. The exact procedure for standard count is listed in the manufacturer's Operator's Manual.

Note 1: New standard counts may be necessary more than once a day. See agency requirements.

Test Site Location

1. Select a test location(s) randomly and in accordance with agency requirements. Test sites should be relatively smooth and flat and meet the following conditions:
 - a. At least 10 m (30 ft.) away from other sources of radioactivity.
 - b. At least 3 m (10 ft.) away from large objects.
 - c. If the gauge will be closer than 600 mm (24 in.) to any vertical mass, or less than 300 mm (12 in.) from a vertical pavement edge, use the gauge manufacturer's correction procedure.

Procedure

1. Maintain maximum contact between the base of the gauge and the surface of the material under test.
2. Use filler material to fill surface voids.
3. Spread a small amount of filler material over the test site surface and distribute it evenly. Strike off the surface with a straightedge (such as a lathe or flat-bar steel) to remove excess material.
4. If using thin-layer mode, enter the anticipated overlay thickness into the gauge.

Note 2: If core correlation is required, entered thickness, anticipated thickness, and nominal core thickness may be required to match.

Method A – Average of two one-minute tests

1. Place the gauge on the test site, perpendicular to the roller passes.
2. Using a crayon (not spray paint), mark the outline or footprint of the gauge.
3. Extend the source rod to the backscatter position.
4. Take a one-minute test and record the wet density reading.
5. Rotate the gauge 90 degrees centered over the original footprint. Mark the outline or footprint of the gauge.
6. Take another one-minute test and record the wet density reading.
7. If the difference between the two one-minute tests is greater than 40 kg/m^3 (2.5 lb/ft^3), retest in both directions. If the difference of the retests is still greater than 40 kg/m^3 (2.5 lb/ft^3) test at 180 and 270 degrees.
8. The density reported for each test site shall be the average of the two individual one-minute wet density readings.

**Direction of
roller pass**

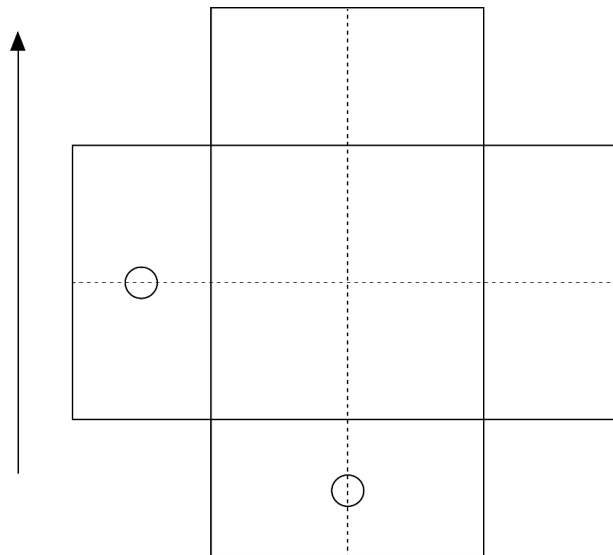

**Method A
Footprint of Gauge Test Site**

Method B – One four-minute test

1. Place the gauge on the test site, parallel to the roller passes.
2. Using a crayon (not spray paint), mark the outline or footprint of the gauge.
3. Extend the source rod to the backscatter position.
4. Take one 4-minute test and record the wet density reading.

**Direction of
roller pass**

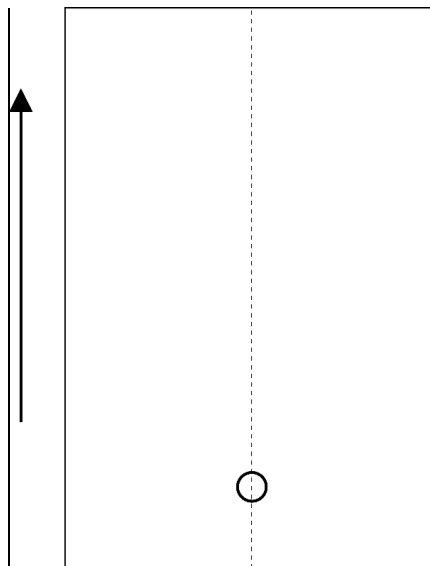

**Method B
Footprint of Gauge Test Site**

Calculation of Results

Percent (%) compaction is determined by comparing the in-place wet density as determined by this method to the appropriate agency density standard. See appropriate agency policy for use of density standards.

$$\% \text{ Compaction} = \frac{\text{Corrected Reading}}{\text{Maximum Density}} \times 100$$

Method A Example:

Reading #1:	141.5 lb/ft ³	
Reading #2:	140.1 lb/ft ³	Are the two readings within the tolerance? (YES)
Reading average:	140.8 lb/ft ³	
Core correction:	+2.1 lb/ft ³	
Corrected reading:	142.9 lb/ft ³	

Method B Example:

Reading:	140.8 lb/ft ³
Core correction:	+2.1 lb/ft ³
Corrected reading	142.9 lb/ft ³

Example percent (%) compaction:

From the FOP for AASHTO T 209:

$$G_{mm} = 2.466$$

$$\text{Theoretical Maximum Density} = 2.466 \times 62.245 \text{ lb/ft}^3 = 153.5 \text{ lb/ft}^3$$

$$\% \text{ Compaction} = \frac{142.9 \text{ lb/ft}^3}{153.5 \text{ lb/ft}^3} \times 100 = 93.1\%$$

Report

- On forms approved by the agency
- Test ID
- Location of test and thickness of layer tested
- Mixture type
- Make, model and serial number of the nuclear moisture-density gauge
- Calculated wet density of each measurement and any adjustment data
- Density standard
- Compaction to the nearest 0.1 percent
- Name and signature of operator

APPENDIX – CORRELATION WITH CORES

(Nonmandatory Information)

The bulk specific gravity (G_{mb}) of the core is a physical measurement of the in-place asphalt mixture and can be compared with the nuclear density gauge readings. Comparing the core value to the corresponding gauge values, a correlation can be established.

The correlation can then be used to adjust the gauge readings to the in-place density of the cores. The core correlation is gauge specific and must be determined without traffic allowed on the pavement between nuclear density gauge readings and obtaining the core. When using multiple nuclear density gauges each gauge should be correlated to the core locations before removal of the core.

When density correlation with the FOP for AASHTO T 166 is required, correlation of the nuclear gauge with pavement cores shall be made on the first day's paving (within 24 hours) or from a test strip constructed before the start of paving. Cores must be taken before traffic is allowed on the pavement.

Correlation with Cores

1. Determine the number of cores required for correlation from the agency's specifications. Cores shall be located on the first day's paving or on the test strip. Locate the test sites in accordance with the agency's specifications. Follow the "Procedure" section above to establish test sites and obtain densities using the nuclear gauge.
2. Obtain a pavement core from each of the test sites according to AASHTO R 67. The core should be taken from the center of the nuclear gauge footprint.

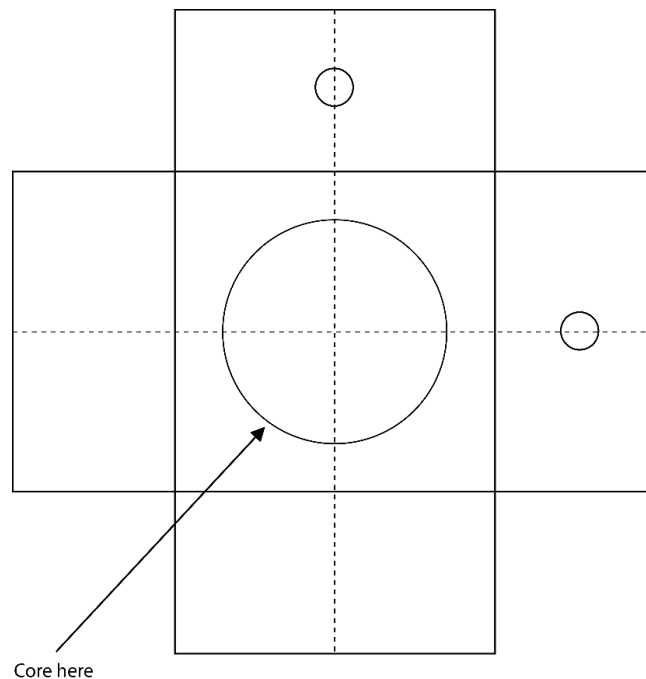

Method A – Footprint of the gauge test site. Core location in the center of the footprint.

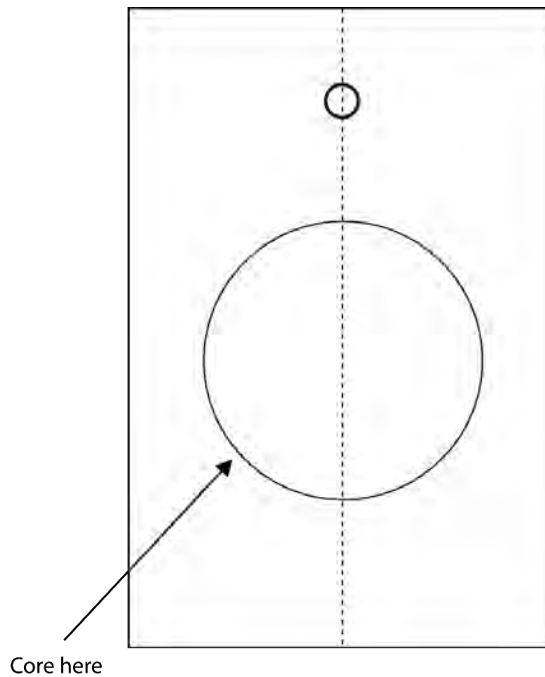

Method B - Footprint of the gauge test site.

3. Determine the density of the cores by the FOP for AASHTO T 166, Bulk Specific Gravity of Compacted Asphalt Mixtures Using Saturated Surface Dry Specimens.
4. Calculate a correlation factor for the nuclear gauge reading as follows:
 - a. Calculate the difference between the core density and the average nuclear gauge density at each test site to the nearest 1 kg/m^3 (0.1 lb/ft^3). Calculate the average difference and standard deviation of the differences for the entire data set to the nearest 1 kg/m^3 (0.1 lb/ft^3).
 - b. If the standard deviation of the differences is equal to or less than 40 kg/m^3 (2.5 lb/ft^3), the correlation factor applied to the average nuclear gauge density shall be the average difference calculated above in 4.a.
 - c. If the standard deviation of the differences is greater than 40 kg/m^3 (2.5 lb/ft^3), the test site with the greatest variation from the average difference shall be eliminated from the data set and the data set properties and correlation factor recalculated following 4.a and 4.b.
 - d. If the standard deviation of the modified data set still exceeds the maximum specified in 4.b, additional test sites will be eliminated from the data set and the data set properties and correlation factor recalculated following 4.a and 4.b. If the data set consists of less than five test sites, additional test sites shall be established.

Note A1: The exact method used in calculating the nuclear gauge correlation factor shall be defined by agency policy.

Note A2: The above correlation procedure must be repeated if there is a new job mix formula. Adjustments to the job mix formula beyond tolerances established in the contract documents will constitute a new job mix formula. A correlation factor established using this procedure is only valid for the particular gauge used in the correlation procedure. If another gauge is brought onto the project, it shall be correlated using the same procedure. Multiple gauges may be correlated from the same series of cores if done at the same time.

Note A3: For the purpose of this procedure, a job mix formula is defined as the percent and grade of paving asphalt used with a specified gradation of aggregate from a designated aggregate source. A new job mix formula may be required whenever compaction of the wearing surface exceeds the agency's specified maximum density or minimum air voids.

Calculations

Correlation Factor

$$\sqrt{\frac{\sum x^2}{n-1}}$$

Where:

\sum = Sum

x = Difference from the average Difference

n-1 = number of data sets minus 1

Example

Core #	Core results from T 166:	Average Gauge reading	Difference:	x	x ²
	144.9 lb/ft ³	142.1 lb/ft ³	2.8 lb/ft ³	-0.7	0.49
2	142.8 lb/ft ³	140.9 lb/ft ³	1.9 lb/ft ³	0.2	0.04
3	143.1 lb/ft ³	140.7 lb/ft ³	2.4 lb/ft ³	-0.3	0.09
4	140.7 lb/ft ³	138.9 lb/ft ³	1.8 lb/ft ³	0.3	0.09
5	145.1 lb/ft ³	143.6 lb/ft ³	1.5 lb/ft ³	0.6	0.36
6	144.2 lb/ft ³	142.4 lb/ft ³	1.8 lb/ft ³	0.3	0.09
7	143.8 lb/ft ³	141.3 lb/ft ³	2.5 lb/ft ³	-0.4	0.16
8	142.8 lb/ft ³	139.8 lb/ft ³	3.0 lb/ft ³	0.9	0.81
9	144.8 lb/ft ³	143.3 lb/ft ³	1.5 lb/ft ³	-0.6	0.36
10	143.0 lb/ft ³	141.0 lb/ft ³	2.0 lb/ft ³	-0.1	<u>0.01</u>
Average Difference:			+2.1 lb/ft ³	$\Sigma x^2 = 2.5$	

Number of data sets

$$n - 1 = 10 - 1 = 9$$

Standard deviation

$$\text{standard deviation} = \sqrt{\frac{2.5}{9}} = 0.53$$

Given:

Sum of x² = 2.5

Number of data sets = 9

The standard deviation of 0.53 is less than 2.5 therefore no cores are eliminated. The average difference from all ten cores is used.

This page intentionally left blank.

ATM 412 Relative Standard Density of Treated Asphalt Mixtures by the Control Strip Method

1. Scope

This method describes a procedure for determining the relative standard wet density of a material by the control strip testing method. This is applicable to granular materials that are bound together with asphalt binders and/or portland cement.

Standard density values established with this method are GAUGE-SPECIFIC and must be determined for each gauge used in acceptance testing of the material. Assurance checks should be of uncorrected wet density readings.

2. Significance and Use

In testing some Asphalt Mixtures, determining the standard density may be difficult with conventional test methods used in the laboratory. When these problems occur a method that allows the determination of a relative standard density in the field can facilitate the verification of compaction efforts. This method describes a procedure to determine the relative standard density to be used in these circumstances.

3. Apparatus

- Nuclear Moisture/Density Gauge—Calibrate and standardize in accordance with ATM 411.
- Compaction equipment that meets the requirements of the contract and of sufficient size and compaction energy to compact the material.

4. Site Preparation

1. The engineer will designate the location and the size of the control strip, as well as minimum compaction equipment to be used.
2. The subgrade will be compacted to a minimum density equal to that required for the material being tested. When the compaction is complete, the Engineer will approve the surface.
3. A representative lift of the material being evaluated will be placed and prepared for compaction.

5. Procedure

1. Attention should be paid to the requirements of the product being placed so that any binder content, temperature and/or moisture requirements are maintained in an acceptable range.
2. A minimum of 3 test locations will be selected with-in the control strip. The locations will be in the middle 1/2 of the control strip and at least 12 in from the edge of the control strip. The Engineer will select test locations.
3. The locations will be marked in such a way as not to be lost during the compaction of the control strip. This can be accomplished by marking the side of the strip with stakes or surveyors tape, or by marking with paint beside the location on the control strip.
4. Care should be taken when choosing and preparing the test location so that it is flat and the surface voids filled. If necessary, use a small quantity of dry sand to fill the voids. This layer will in no case be more than 1/8 in in depth.
5. Tests shall be taken in backscatter mode. (Direct transmission may be used on crushed asphalt products.) A test will consist of one 1 minute reading or the average of two 15 second readings (fast mode). Record

all readings of wet density and moisture content. In the case of the 15 second readings calculate the average wet density determination at each location.

6. After the first pass with the compaction equipment, an initial density test is taken and recorded.

Note 1: One pass of the roller will be defined as one roll over the location.

7. After each subsequent pass and for each piece of compaction equipment used, a test is taken at each location and recorded.
8. Continue the compaction and testing cycle until there is a pass with less than 16 kg/m³ (1 lb/ft³) increase in the average wet density of the test locations; and a second consecutive pass with less than 16 kg/m³ (1 lb/ft³) increase in the average wet density of the test locations.

Note 2: If additional passes are performed there is risk that the treated mix will check or crack.

9. Select ten random locations on the completed control strip and test by averaging two one minute counts at each location in accordance with ATM 411. Average the results from the ten locations and this value will be the relative wet standard density for this material.

Note 3: It may be necessary to repeat the procedure for additional roller types depending on the material to be tested and the requirements of sequencing for the finished surface.

10. Additional control strips may be required if there are changes in the material, lift thickness or compaction equipment.

6. Calculations

The Relative Standard Density value will be calculated as follows:

$$D_s = \frac{(A_1 + A_2 + A_3 + A_4 + A_5 + A_6 + A_7 + A_8 + A_9 + A_{10})}{10}$$

Where:

D_w = Relative Standard Wet Density for the material.

A_n = Average Wet Density for random test location n.

7. Report

- Report the average wet density for each pass
- Report the relative standard wet density to the nearest 0.1 lb/ft³

 <p>STATE OF ALASKA DOT & PF Construction</p> <p>ATM 412 Control Strip FIELD WORKSHEET</p>	<input type="checkbox"/> Acceptance <input type="checkbox"/> Information <input type="checkbox"/> Assurance	
	Project Name: _____	
	State No: _____	
	Material	Source
Item No.	Spec.	Gauge Serial No

FIELD DENSITY TEST NUMBER									
STATION									
STATION									
STATION									
C/L REFERENCE									
C/L REFERENCE									
C/L REFERENCE									
GRADE REFERENCE									
QUANTITY REPRESENTED									
DATE TESTED									
STANDARD DENSITY BY:		<input type="checkbox"/> ATM 412	<input type="checkbox"/> ASTM D 1557	<input type="checkbox"/> ATM T-12					
Lab Number									
(A) Standard Density (Field Established)									
Optimum Moisture									
(B) Bulk Specific Gravity									
DENSITY DETERMINATION									
Probe Depth		Backscatter		Backscatter		Backscatter		Backscatter	
		Reading #1	Reading#2	Reading #1	Reading #2	Reading #1	Reading#2	Reading #1	Reading#2
Wet Density, lbm/f ³	Gauge Readings								
Wet Density, lbm/f ⁴	Gauge Readings								
Wet Density, lbm/f ⁵	Gauge Readings								
(C) Average Wet Density									
% COMPACTION	C/A x 100								

REMARKS:	
	Signature: _____
	Checked by: _____
	Date: _____

**Figure 412-1
Control Strip Field Worksheet Example**

 STATE OF ALASKA DOT & PF Construction ATM 412 Control Strip FIELD WORKSHEET	<input checked="" type="checkbox"/> Acceptance <input type="checkbox"/> Information <input type="checkbox"/> Assurance	
	Project Name: Kotzebue A/P & Safety Area Improvements	
	State No: AIP 3-02-0160-016 2010	
	Material: RAP	Source: Existing
Item No: P-161	Spec. 98%	Gauge Serial No: 22929

FIELD DENSITY TEST NUMBER	RAP-D-46	RAP-D-47	RAP-D-47R	RAP-D-48				
STATION	112+27	423+08	422+77	440+69				
STATION								
STATION								
C/L REFERENCE	12' RCL	06' LCL	CL	5' RCL				
C/L REFERENCE								
C/L REFERENCE								
GRADE REFERENCE	Top RAP	Top RAP	Top RAP	Top RAP				
QUANTITY REPRESENTED	1000 tons	1000 tons	1000 tons	1000 tons				
DATE TESTED								
STANDARD DENSITY BY:		<input checked="" type="checkbox"/> ATM 412	<input type="checkbox"/> ASTM D 1557	<input type="checkbox"/> ATM T-12				
Lab Number	RAP-SD-4	RAP-SD-4	RAP-SD-4	RAP-SD-4				
(A) Standard WET Density (Field Establis	150.4	150.4	150.4	150.4				
Optimum Moisture	N/A	N/A	N/A	N/A				
(B) Bulk Specific Gravity	N/A	N/A	N/A	N/A				
DENSITY DETERMINATION								
Probe Depth	Backscatter		Backscatter		Backscatter		Backscatter	
	Reading #1	Reading#2	Reading #1	Reading #2	Reading #1	Reading#2	Reading #1	Reading#2
Wet Density, lbm/f ³	Gauge Readings: 147.4	147.8	142.3	139.7	148.1	147.4	149.2	148.7
Wet Density, lbm/f ⁴	Gauge Readings:							
Wet Density, lbm/f ⁵	Gauge Readings:							
(C) Average Wet Density	147.6		141.0		147.8		149.0	
% COMPACTION	C/A x 100	98%		91%		98%		99%

REMARKS	Signature: _____
	Checked by: _____
	Date: _____

Figure 412-2
Control Strip Field Worksheet Example

ATM 413 Standard Practice for Sampling Asphalt Mixtures after Compaction (Obtaining Cores)

Following are guidelines for the use of AASHTO R 67 by the State of Alaska DOT&PF. (Replaces WAQTC TM 11).

1. When cores are used to determine gauge correlation use:

- AASHTO T 355 for nuclear gauges
- AASHTO T 343 for electronic gauges

When cores are used to determine pavement density, the Bulk Specific Gravity (G_{mb}) is determined according to WAQTC FOP for AASHTO T 166.

2. While saw cutting is the preferred method, the different layers in a core may be separated by freezing and use of a chisel and hammer or by use of a hammer and chisel alone if a saw is not available. Care must be taken to protect the core from deformation or damage during the separation. If the core is deformed or damaged, it must be discarded and a new core taken.
3. Core locations – Joint cores shall be centered on the longitudinal joint. Mat cores shall be located at least 12” from all joints and outside pavement edge.
4. Core Locations – core locations shall be independent of other sampling.
5. When determining mat depth (thickness), determine and record the length (height) of the core to 5 mm (1/4”) in three places and record the average.
6. Damaged cores shall be replaced by cores located within 12” of the original test.
7. When material is sampled by other than DOT&PF personnel or their agent(s), the sampling must be witnessed and possession taken immediately by DOT&PF personnel or their agent(s).
8. Test Site Location
 - The number of cores obtained shall be determined by the test procedure or agency requirements.
 - Core location(s) shall be determined by the Department.
9. Replace **2. Filling Core Holes** in its entirety with:

Filling Core Holes

Within 24 hours of coring, the contractor shall clean and dry the core-holes, tack the cut wall surfaces with hot asphalt oil, fill the hole with hot mix asphalt (at, or exceeding, compaction temperature) in lifts of loose thickness that will produce a compacted lift thicknesses of approximately 2” and compact each lift with a 4” face diameter Marshal hammer, using a minimum of 50 blows on each lift of compacted asphalt mix placed in the patch. Finished surface of patched hole must be level with existing paving.

10. APPENDIX - Thickness Determination is required

This page intentionally left blank.

SAMPLING ASPHALT MIXTURES AFTER COMPACTION (OBTAINING CORES)

AASHTO R 67-16

Scope

This method describes the process for removal of a core sample of hot mix asphalt (HMA) from a pavement for laboratory testing. Cores may range in diameter from 2 in. to 12 in.

Safety— This standard does not purport to address all of the safety concerns, if any, associated with its use. It is the responsibility of the user of this standard to establish appropriate safety and health practices and determine the applicability of regulatory limitations prior to use

Significance

Samples obtained in accordance with the procedure may be used for measuring pavement thickness and density. Additional testing may be performed as required by the agency.

Apparatus

- **Coring Machine** – A motor driven core machine shall be used to obtain the sample. The device shall be capable of obtaining a core to the full depth of the HMA and mounted on a platform such that the core barrel is perpendicular to the pavement during the cutting process. A Core Drill Machine of sufficient horsepower and depth to minimize distortion of the compacted cores of HMA.
- **Core Bit** – The cutting edge of the core drill bit shall be of hardened steel or other suitable material with diamond chips embedded in the metal cutting edge. The core barrel inside diameter shall be as specified.
- **Separation Equipment** – A saw or other method(s) that provides a clean smooth plane representing the layer to be tested without damaging the specimen.
- **Retrieval Device** – A device for removing core samples that will preserve the integrity of the core. The device may be a steel rod of suitable length and with a diameter that will fit into the space between the core and the pavement material. There may be a 90 degree bend at the top to form a handle and a 90 degree bend at the bottom, approximately 2 in. (50 mm) long, forming a hook to assist in the retrieval of the core or other suitable device.

Note 1—Suitable devices have been made from steel rods, wire, or banding material.

- **Cooling agent** such as: water, ice, dry ice, or liquid nitrogen.
- **Sample Marking Tool**—A lumber crayon, paint stick, pen, or other suitable marking tool to mark the core sample for labeling, identifying the separation layers, identifying the layer to test, or as otherwise necessary
- **Package Containers**—Suitable packaging containers for securing and transporting the core samples

Procedure

1. For freshly compacted HMA, the core shall be taken when the material has had sufficient amount of time to cool to prevent damage to the core.
2. To accelerate the coring process, a cooling agent may be used.
3. Provide a means such as water or air to aid in the removal of cuttings and to minimize the generation of heat caused by friction
4. Position the coring machine above the selected location. Engage power and water or air source to coring machine. Slowly advance bit until contact with the HMA surface.
5. Keep the core bit perpendicular to the HMA surface applying constant pressure during the process.

Note 2: If any portion of the coring machine shifts during the operation, the core may break or distort. Failure to apply constant pressure, or too much pressure, may cause the bit to bind or distort the core.

6. Apply constant downward pressure on the core bit. Failure to apply constant pressure, or too much pressure, may cause the bit to bind or distort the core.
7. Continue the core drilling to the bottom or slightly below the bottom of the asphalt mixture intended to be samples to allow separation of the core sample at the desired depth from the underlying pavement layers.
8. After drilling, separate the core sample from the underlying pavement layers using the retrieval device or other suitable means, without damaging or distorting the sample. Obtain the core sample using the retrieval device.

Note 2: If the core is damaged to a point that it cannot be used for its intended purpose, a new core shall be obtained within 6 in. of the original location

9. Clearly label the core with a sample marking tool.

Filling Core Holes

Fill the hole made from the coring operation with HMA, non-shrink grout, or other suitable material. Consolidate or compact the material in the hole, multiple lifts may be required. Ensure that the final surface is level with the surrounding surface.

Packaging And Transporting Samples

- Transport cores in a manner that prevents damage from jarring, rolling or impact with any object.
- Prevent cores from freezing or from excessive heat, 54° C (130° F), during transport.

Note 3: In extreme ambient temperature conditions, an insulated container should be used during transport.

- If the core is damaged in transport to a point it cannot be utilized for its intended purpose the core will not be used

Layer Separation

Separate two or more pavement courses, lifts, or layers; on the designated lift line using appropriate separation equipment.

Note 4: Lift lines are often more visible by rolling the core on a flat surface.

Report

- On forms approved by the Department
- Date the cores were obtained
- Paving date
- Coring location
- The lift / layer being evaluated
- Material type
- Average thickness
- Core identification information, such as nominal-maximum aggregate size of the mixture, asphalt mixture design identification, performance grade of asphalt binder, etc.

APPENDIX

(Non mandatory Information)

Thickness Determination

Measure the thickness of the designated lift according to ASTM D3549/D3549M to the nearest 0.01 ft, 1/8 in., or 3 mm. Calculate an average of three or more measurements taken around the lift.

This page intentionally left blank.

ATM 414 Anti-Strip Requirements of Asphalt Mixtures

1. Scope

This method describes a procedure for determining the retention of a bituminous film by aggregate in the presence of water. It is applicable to asphalt cements, cutback asphalts and emulsified asphalts.

2. Apparatus

- Balance or scale: Capacity sufficient for the principle sample mass, readable to 0.1 percent of the total sample mass and meeting the requirements of AASHTO M 231.
- Thermostatically controlled oven capable of maintaining any required constant temperature between $49-150 \pm 1^\circ\text{C}$ ($120-300 \pm 2^\circ\text{F}$).
- A 9.5 mm ($\frac{3}{8}$ ") and a 4.75 mm (No. 4) mm sieve conforming to ASTM E11.
- 600 mL beakers, low form glass or plastic type.
- Thermostatically controlled water bath capable of maintaining a temperature of $49 \pm 1^\circ\text{C}$ ($120 \pm 2^\circ\text{F}$).
- Miscellaneous equipment including a steel spatula with stiff blade (approximately $\frac{1}{2}$ " wide x 4" long (12.5 mm x 100 mm), glass or plastic containers for mixing samples, and air-tight containers of suitable size for storing bitumen and anti-strip mixtures.

3. Sample Preparation

1. Aggregate:
 - a. The test aggregate shall be processed in the same manner as that which would be used during the construction process.
 - b. Dry the aggregate to a constant weight in accordance with WAQTC FOP for AASHTO T 255.
 - c. Separate the aggregate by sieving to obtain the minus 9.5 mm ($\frac{3}{8}$ ") plus (No. 4) material. Reduce this material, in accordance with WAQTC FOP for AASHTO T 248, Method A, to obtain approximately 1200 g.
2. Anti-stripping additive used in testing will be the same brand and type proposed for use on the project.
3. Bitumen and/or emulsified asphalts will be the same type and grade proposed for use in mix design.

4. Procedure

1. For asphalt cement and/or cutback asphalt samples:
 - a. Thoroughly mix the bitumen samples with the anti-strip additive in the proportions provided in the table below, or as required. If necessary to store this mixture, use airtight containers.

Liquid Anti-strip Type	Minimum Dose by weight of asphalt binder
Amines based (including plant-derived)	0.25, 0.50, and 0.75 percent
Phosphate Ester based	0.25, 0.50, and 0.75 percent
Organo-Silane based	0.05, 0.075, and 0.1 percent

Note 1: After the additive is added to the bitumen standards they shall not be reheated in excess of preheat temperatures as outlined in (1) and (2) below.

- b. Make up 1 or more aggregate specimens per additive content by placing 100 ± 1 g of the aggregate to be tested into individual mixing containers.
- c. Preheat aggregate specimens to the temperature of the respective bitumen below:
 - (1) Asphalt binder: Preheat in oven at a temperature within the binders mixing temperature range for no longer than 30 minutes.
 - (2) Cut-back asphalts:
Grades 30 to 250. No preheat required.
Grades 800 to 3000: Preheat at $60\text{--}90^\circ\text{C}$ ($140\text{--}195^\circ\text{F}$) for no longer than 30 minutes.
- d. Preheat the binder at the respective temperatures above until it can be poured.
- e. Add 5.5 ± 0.5 g of binder-additive mixture to the aggregate specimen(s).
- f. Mix the binder and aggregate thoroughly until uniformly coated.
- g. The binder-aggregate specimen(s) shall be oven-cured at a temperature $60 \pm 1^\circ\text{C}$ ($140 \pm 2^\circ\text{F}$) for a minimum of 18 hours but no more than 24 hours.
- h. Remove the sample(s) from the oven and re-mix to obtain a uniform coating. Allow the specimen(s) to cool to a temperature of 49°C (120°F) or less.
- i. Place 50 ± 1 g of each of the coated aggregates into individual 600 ml. beakers.
- j. Add 400 mL distilled water, cover and place in an oven or water bath maintained at $49 \pm 1^\circ\text{C}$ ($120 \pm 2^\circ\text{F}$) for 24 hours. If a water bath is used, the container(s) shall not be submerged so as to allow bath water into the beakers.

2. For emulsified asphalts (anionic/cationic):

Important: Anti-stripping additive will not be used with emulsified asphalts.

- a. Preheat the emulsified asphalt to $38 \pm 1^\circ\text{C}$ ($100 \pm 2^\circ\text{F}$). Mix the asphalt thoroughly.
- b. Make up 3 aggregate samples by placing 100 ± 1 g of the aggregate into individual containers.
- c. Preheat aggregate specimens to the emulsified asphalt preheat temperature listed in Step 1.c (2).
- d. Add 8.0 ± 0.5 g of each emulsion to the 100 g samples of aggregate and mix until the stones are uniformly coated.
- e. The emulsion-coated aggregate shall be cured at $132 \pm 3^\circ\text{C}$ ($270 \pm 5^\circ\text{F}$) for a minimum of 18 hours but no more than 24 hours.
- f. Follow Steps 1.h thru 1.j.

5. Observations

1. Without disturbing or agitating the coated aggregate, remove any film floating on the water surface.
2. By observation through the water from above, estimate to the nearest 10 percent of the total visible surface area the aggregate coated with binder. Any thin brownish translucent areas are to be considered fully coated.
3. Average the results if more than one specimen was prepared for each additive content.

6. Report

- Report the results on Department forms. The results will include the following:
- The visible binder/emulsion-covered area estimated to the nearest 10 percent for each additive content tested.
- The lowest percentage of additive required to obtain a 90 percent binder coating on the aggregate.
- Type and grade of binder/emulsion used.
- Brand of anti-stripping agent use.
- When performed for a specific mix design, report the results on the mix design report.

This page intentionally left blank

ATM 415 Preparing and Determining the Density of Asphalt Mixture Specimens by means of the Super Gyrotory Compactor

Following are guidelines for the use of WAQTC FOP for AASHTO T312 by the State of Alaska DOT&PF.

This page left intentionally blank.

PREPARING AND DETERMINING THE DENSITY OF ASPHALT MIXTURE SPECIMENS BY MEANS OF THE SUPERPAVE GYRATORY COMPACTOR FOP FOR AASHTO T 312

Scope

This procedure covers preparing specimens, using samples of plant produced asphalt mixtures, for determining the mechanical and volumetric properties of asphalt mixtures in accordance with AASHTO T 312-22.

Apparatus

- Superpave Gyratory Compactor (SGC) meeting the requirements of AASHTO T 312
- Molds meeting the requirements of AASHTO T 312
- Chute, mold funnel or both (Optional)
- Scale meeting the requirements of AASHTO M 231 Class G 5
- Oven, thermostatically controlled, capable of maintaining set temperature within $\pm 3^{\circ}\text{C}$ ($\pm 5^{\circ}\text{F}$)
- Thermometers with a temperature range of at least 10 to 230°C (50 - 450°F) and accurate to $\pm 1^{\circ}\text{C}$ ($\pm 2^{\circ}\text{F}$)

Note 1: Non-Contact thermometers are not acceptable.

- Miscellaneous pans, spoons, spatulas, hot pads, gloves, paper discs, markers, etc.

Equipment Requirements

The calibration shall be performed on the SGC per the Manufacturer's instructions. See agency requirements for the calibration frequency.

The mold and base plate dimensions shall be checked every twelve months or 80 hours of operation to determine that they are within the tolerances listed in AASHTO T 312.

Equipment Preparation

Prepare the equipment in accordance with manufacturer's recommendations. At a minimum preparation includes:

- Warm-up gyratory compactor
- Verify machine settings
 - Internal Angle: $1.16 \pm 0.02^{\circ}$
 - Ram Pressure: $600 \text{ kPa} \pm 18 \text{ kPa}$
 - Number of gyrations

Note 2: The number of gyrations (N_{des}) is obtained from the Job Mix Formula (JMF).

- Lubricate bearing surfaces
- Prepare recording device as required
- Pre-heat molds and plates at the compaction temperature range (minimum of 30 min.) or before reuse reheat (minimum of 5 min.)

Note 3: The use of multiple molds will speed up the compaction process.

- Pre-heat chute, mold funnel, spatulas, and other apparatus (not to exceed the maximum compaction temperature)

Sample Preparation

Laboratory Prepared Asphalt Mixtures

This is a sample produced during the Mix Design process using aggregate and binder that is combined in the laboratory. When designing asphalt mixtures using the gyratory compactor, refer to AASHTO T 312 and AASHTO R 35.

Plant Produced Asphalt Mixtures

- Determine initial sample size, number of gyrations (N_{des}), and compaction temperature range from the Job Mix Formula (JMF).
- Obtain the sample in accordance with the FOP for AASHTO R 97.
- Reduce the sample in accordance with the FOP for AASHTO R 47.
- The sample size should be such that it results in a compacted specimen that is 115 ± 5 mm at the desired number of gyrations.

Note 4: Replicate specimens are generally prepared. Refer to agency requirements.

If the material is not in the compaction temperature range:

1. Place the appropriate sample mass into a container.
2. Spread to a depth of 1 to 2 in. for even heating of mixture.
3. Place in the oven until the material is within the compaction temperature range.

Note 5: The material properties may be altered when the times of delivery of the test sample and the placement of the material on the roadway are different.

Compaction Procedure

Follow the manufacturer's recommended loading procedure. This may require the steps below to be performed in a different order. Steps 1 through 8 must be performed before the sample and mold cools below minimum compaction temperature.

1. Remove pre-heated mold and plate(s) from the oven (verify mold and plate(s) has been cleaned if previously used).
2. Place the base plate and paper disc in bottom of mold.
3. Place the mix into the mold in a single lift (care should be taken to avoid segregation or loss of material).
4. Level the mix in the mold.
5. Place a paper disc and the heated upper plate (if required) on top of the leveled sample.
6. Load the mold into the compactor, check settings.
7. Start the compaction process.
 - a. Check the pressure (600 ± 18 kPa).
 - b. Check the angle ($1.16 \pm 0.02^\circ$).

8. Extrude the specimen from the mold; a brief cooling period may be necessary before fully extruding some specimens to ensure the specimens are not damaged.

Note 6: Clean molds after each use.

9. Upon completion of the compaction process, record the number of gyrations and specimen height.

Note 7: If the specimen is not 115 ± 5 mm, follow agency requirements.

10. Carefully remove the paper discs.
11. Cool the compacted specimen to room temperature.
12. Identify the specimen with chalk or other marker.

Report

- On forms approved by the agency
- Sample ID
- Number of gyrations
- Specimen height to the nearest 0.1 mm

This page intentionally left blank.

ATM 416 Volumetric Properties of Asphalt Mixtures- WAQTC TM 13

The following are guidelines for using the FOP for WAQTC TM 13 by the State of Alaska DOT&PF.

This page intentionally left blank.

VOLUMETRIC PROPERTIES OF ASPHALT MIXTURES

WAQTC TM 13

Scope

This procedure covers the determination of volumetric properties of plant produced asphalt mixtures, i.e., air voids (V_a), voids in mineral aggregate (VMA), voids filled with asphalt binder (VFA), effective asphalt binder content (P_{be}) and Dust to Binder Ratio ($P_{\#200}/P_{be}$). The in-production volumetric properties are then compared to agency specifications.

Definition of Terms

- G_{mm} = theoretical maximum specific gravity (Gravity_{mix max})
- G_{mb} = measured bulk specific gravity (Gravity_{mix bulk})
- G_{sb} = oven-dry bulk specific gravity of aggregate (Gravity_{stone bulk})
- G_{sa} = apparent specific gravity of aggregate (Gravity_{stone apparent})
- G_{se} = effective specific gravity of aggregate (Gravity_{stone effective})
- G_b = specific gravity of the binder (Gravity_{binder})
- V_a = air Voids (Voids_{air})
- VMA = Voids in Mineral Aggregate
- VFA = Voids Filled with Asphalt (binder)
- V_{ba} = absorbed binder volume (Voids_{binder absorbed})
- V_{be} = effective binder volume (Voids_{binder effective})
- P_b = percent binder content (Percent_{binder})
- P_{ba} = percent absorbed binder (Percent_{binder absorbed})
- P_{be} = percent effective binder content (Percent_{binder effective})
- P_s = percent of aggregate (Percent_{stone})
- DP = Dust proportion to effective binder ratio
($P_{\#200}/P_{be}$)

Background

Whether a mix design is developed through a Marshall, Hveem, or Superpave mix design process there are basic volumetric requirements of all. Volumetric properties are the properties of a defined material contained in a known volume. Asphalt mixture volumetric properties can include bulk specific gravity, theoretical maximum specific gravity, air voids, and voids in mineral aggregate.

Many agencies specify values of the volumetric properties to ensure optimum performance of the pavement. The asphalt mixture must be designed to meet these criteria. In production the asphalt mixture is evaluated to determine if the mix still meets the specifications and is consistent with the original mix design (JMF). The production asphalt mixture may vary from the mix design and may need to be modified to meet the specified volumetric criteria.

To compare the in-production volumetric properties to agency specifications and the JMF a sample of loose asphalt mixture mix is obtained in accordance with FOP for AASHTO R 97. The sample is then compacted in a gyratory compactor to simulate the in-place asphalt mixture pavement after it has been placed, compacted, and the volumetric properties of the compacted sample are determined.

Asphalt mixture phase diagram

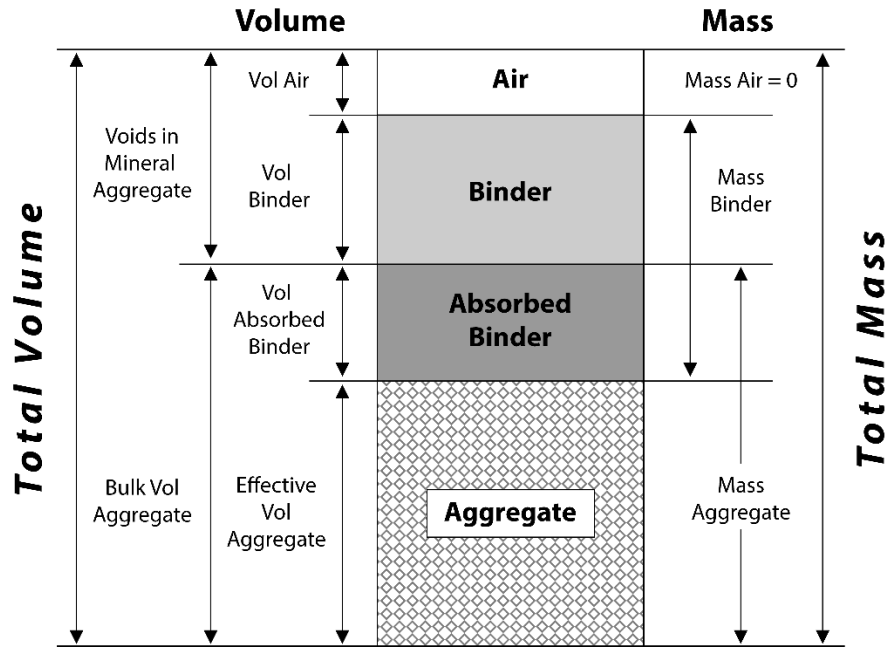

Each of the properties in the asphalt mixture phase diagram can be measured or calculated. For example: The mass of the aggregate is measured; the voids in mineral aggregate (VMA) is calculated; total asphalt binder can be measured but the amount available to act as a binder in the mix must be calculated because it is the quantity left after the aggregate has absorbed some of the asphalt binder.

The volumetric proportions of the asphalt binder and aggregate components of an asphalt mixture and their relationship to the other components are considered. The mass of the components and their specific gravities are used to determine the volumes of each of the components in the mix. The volumetric properties of a compacted asphalt mixture: air voids (V_a), voids in mineral aggregate (VMA), voids filled with asphalt binder (VFA), and effective asphalt binder content (P_{be}) provide some indication of the mixture's probable performance.

Volumetric Properties

Volumetric Relationship of Asphalt Mixture Constituents

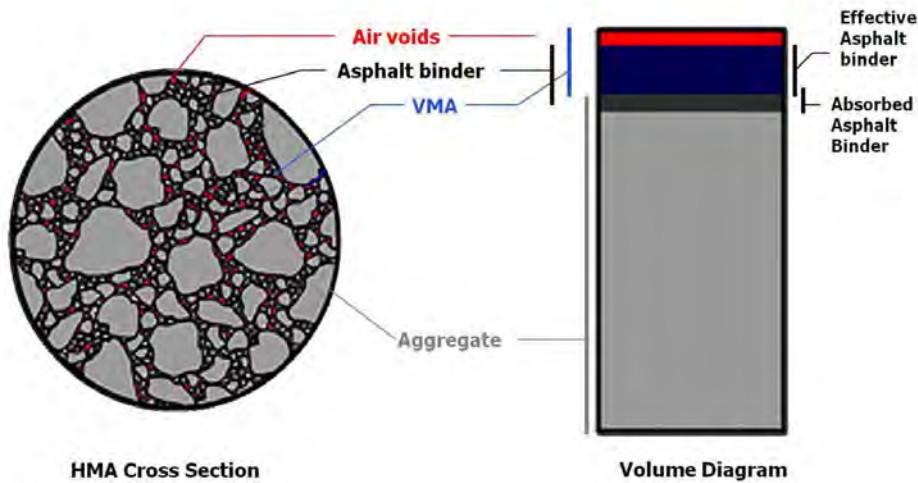

Required Values

The specific gravities listed in Table 1 and the percent by mass of each of the components in the asphalt mixture are needed to determine the volumetric properties. Other values required are also listed. Some of these values are obtained from the JMF and some are measured from a plant produced asphalt mixture sample.

Table 1

Data	Test Method	Obtained
G _{sb} - combined aggregate bulk specific gravity	AASHTO T 84 / T 85 or agency approved test method	JMF or performed at the beginning of placement
G _b – measured specific gravity of the asphalt binder	AASHTO T 228	JMF or from the supplier
G _{mm} – measured maximum specific gravity of the loose mix	FOP for AASHTO T 209	Performed on the field test sample
G _{mb} – measured bulk specific gravity of the compacted paving mix	FOP for AASHTO T 166	Performed on the field compacted specimen
P _b – percent asphalt binder	FOP for AASHTO T 308	Performed on the field test sample
P _{#200} – aggregate passing the #200 (75 μm) sieve	FOP for AASHTO T 30	Performed on the field test sample

Air Voids (V_a)

Air voids are the total volume of the small pockets of air between the coated aggregate particles throughout a compacted paving mixture. Appropriate air voids contribute to the stability of the asphalt mixture and help the pavement withstand the combined action of environment and traffic loads. The designated percent air voids allows for thermal expansion of the asphalt binder and contributes a cushion for future compaction. Air voids are expressed as a percent of the bulk volume of the compacted mixture (G_{mb}) when compared to the maximum specific gravity (G_{mm}).

$$V_a = 100 \left[\frac{(G_{mm} - G_{mb})}{G_{mm}} \right]$$

Where:

- V_a = air voids in compacted mixture, percent of total volume (report to 0.1)
- G_{mm} = maximum specific gravity of paving mixture (AASHTO T 209)
- G_{mb} = bulk specific gravity of compacted mixture (AASHTO T 166)

Percent Aggregate (Stone) (P_s)

P_s is the percent aggregate (stone) content, expressed as a percentage of the total mass of the sample.

$$P_s = 100 - P_b$$

Where:

- P_s = percent aggregate (stone) percent by total weight
- P_b = asphalt binder content (AASHTO T 308)

Voids in the Mineral Aggregate (VMA)

VMA is the volume of intergranular void space between the aggregate particles of the compacted paving mixture that includes the air voids and the effective binder content, expressed as a percent of the total volume of the sample.

$$VMA = 100 - \left[\frac{(G_{mb} \times P_s)}{G_{sb}} \right]$$

Where:

- VMA = voids in mineral aggregate, percent of bulk volume (report to 0.1)
- G_{sb} = bulk specific gravity of combined aggregate (AASHTO T 85 / T 84 or agency approved method from Job Mix Formula)
- G_{mb} = bulk specific gravity of compacted mixture (AASHTO T 166)
- P_s = aggregate content, percent by total weight = 100 – P_b
- P_b = asphalt binder content (AASHTO T 308) percent by total weight

Voids Filled with Asphalt (binder) (VFA)

VFA is the volume of space between the aggregate particles of the compacted paving mixture filled with asphalt binder, expressed as a percent of the total volume of the sample. The VFA increases as the asphalt binder content increases as it is the percent of voids that are filled with asphalt which doesn't include the absorbed asphalt.

$$VFA = 100 \left[\frac{(VMA - V_a)}{VMA} \right]$$

Where:

- VFA = voids filled with asphalt, percent of VMA (report to 1)
- VMA = voids in mineral aggregate, percent of bulk volume
- V_a = air voids in compacted mixture, percent of total volume.

Effective Specific Gravity of the Aggregate (Stone) (G_{se})

The G_{se} is used to quantify the asphalt binder absorbed into the aggregate particle. This is a calculated value based on the specific gravity of the mixture, G_{mm}, and the specific gravity of the asphalt binder, G_b. This measurement includes the volume of the aggregate particle plus the void volume that becomes filled with water during the test soak period minus the volume of the voids that absorb asphalt binder. Effective specific gravity lies between apparent and bulk specific gravity.

G_{se} is formally defined as the ratio of the mass in air of a unit volume of a permeable material (excluding voids permeable to asphalt binder) at a stated temperature to the mass in air (of equal density) of an equal volume of gas-free distilled water at a stated temperature.

$$G_{se} = \frac{P_s}{\left[\left(\frac{100}{G_{mm}} \right) - \left(\frac{P_b}{G_b} \right) \right]}$$

Where:

- G_{se} = effective specific gravity of combined aggregate (report to 0.001)
- P_s = aggregate content, percent by total weight = 100 – P_b
- G_{mm} = maximum specific gravity of mix (AASHTO T 209)
- P_b = asphalt binder content (AASHTO T 308) percent by total weight
- G_b = specific gravity of asphalt binder (JMF or asphalt binder supplier)

Percent of Absorbed (asphalt) Binder (P_{ba})

P_{ba} is the total percent of the asphalt binder that is absorbed into the aggregate, expressed as a percentage of the mass of aggregate rather than as a percentage of the total mass of the mixture. This portion of the asphalt binder content does not contribute to the performance of the mix.

$$P_{ba} = 100 \left[\frac{(G_{se} - G_{sb})}{(G_{sb} \times G_{se})} \right] G_b$$

Where:

- P_{ba} = absorbed asphalt binder (report to 0.01) percent of aggregate
- G_{se} = effective specific gravity of combined aggregate
- G_{sb} = bulk specific gravity of combined aggregate (AASHTO T 85 / T 84 or agency approved method from Job Mix Formula)
- G_b = specific gravity of asphalt binder (JMF or asphalt binder supplier)

Percent of Effective (asphalt) Binder (P_{be})

P_{be} is the total asphalt binder content of a paving mixture minus the portion of asphalt binder that is lost by absorption into the aggregate particles, expressed as a percentage of the mass of aggregate. It is the portion of the asphalt binder content that remains as a coating on the outside of the aggregate particles. This is the asphalt content that controls the performance of the mix.

$$P_{be} = P_b - \left[\frac{P_{ba}}{100} \times P_s \right]$$

Where:

- P_{be} = effective asphalt binder content (report to 0.01), percent by total weight
- P_s = aggregate content, percent by total weight = $100 - P_b$
- P_b = asphalt binder content (AASHTO T 308) percent by total weight
- P_{ba} = absorbed asphalt binder

Dust Proportion – DP (Dust to Effective (asphalt) Binder Ratio)

The DP is the percent passing the No. 200 sieve of the gradation divided by the percent of effective asphalt binder. Excessive dust reduces asphalt binder film thickness on the aggregate which reduces the durability. Insufficient dust may allow excessive asphalt binder film thickness, which may result in a tender, unstable mix.

$$DP = \frac{P_{\#200}}{P_{be}}$$

Where:

- DP = Dust Proportion, (dust-to-binder ratio) (report to 0.01)
- $P_{\#200}$ = aggregate passing the -#200 (75 μ m) sieve, percent by mass of aggregate (AASHTO T 30)
- P_{be} = effective asphalt binder content, percent by total weight

Mix Design and Production Values

Job Mix Formula

Table 2 includes example data required from the JMF. Some of these values are used in the example calculations.

Note: Some of the targets may change after the asphalt mixture is in production based on field test data.

Table 2

JMF Data	
Asphalt binder grade	PG 64-28
N_{values}	$N_{ini} = 7$ $N_{des} = 75$

	$N_{max} = 115$
G_{sb} (combined specific gravity of the aggregate)	2.678
Target P_b	4.75%
Initial sample mass for gyratory specimens	4840 grams
Mixing temperature range	306 – 312 °F
Laboratory compaction temperature range	286 – 294 °F
G_b (specific gravity of the asphalt binder)	1.020
Target gradation	
Sieve Size mm (in.)	Percent Passing
19.0 (3/4)	100
12.5 (1/2)	85
9.5 (3/8)	80
4.75 (No. 4)	50
2.36 (No. 8)	30
0.18 (No. 16)	25
0.600 (No. 30)	15
0.300 (No. 50)	10
0.150 (No. 100)	7
75 μ m (No. 200)	5.0

Sample Test Result

Tables 3 and 4 include data from test results performed on a field sample of asphalt mixture used in the example calculations.

Table 3

Field Data		
	Test method	Example values
P_b	FOP for AASHTO T 308	4.60%
G_{mb}	FOP for AASHTO T 166	2.415
G_{mm}	FOP for AASHTO T 209	2.516

Table 4

Sieve Analysis		
FOP for AASHTO T 30		
Sieve Size mm (in.)	Percent Passing	
19.0 (3/4)	100	
12.5 (1/2)	86	

9.5 (3/8)	77
4.75 (No. 4)	51
2.36 (No. 8)	34
01.18 (No. 16)	23
0.600 (No. 30)	16
0.300 (No. 50)	12
0.150 (No. 100)	8
75 μm (No. 200)	4.9

Sample Calculations

Air Voids (V_a)

$$V_a = 100 \left[\frac{(G_{mm} - G_{mb})}{G_{mm}} \right]$$

$$V_a = 100 \left[\frac{(2.516 - 2.415)}{2.516} \right] = 4.01431\% \text{ report } 4.0\%$$

Given:

$$G_{mm} = 2.516$$

$$G_{mb} = 2.415$$

Percent Aggregate (Stone) (P_s)

$$P_s = 100 - P_b$$

$$P_s = 100.0 - 4.60\% = 95.40\%$$

Given:

$$P_b = 4.60\%$$

Voids in the Mineral Aggregate (VMA)

$$VMA = 100 - \left[\frac{(G_{mb} \times P_s)}{G_{sb}} \right]$$

$$VMA = 100.0 - \left[\frac{2.415 \times 95.40\%}{2.678} \right] = 13.96\% \text{ report } 14.0\%$$

Given:

$$G_{sb} = 2.678$$

Voids Filled with Asphalt (binder) (VFA)

$$VFA = 100 \left[\frac{(VMA - V_a)}{VMA} \right]$$

$$VFA = 100 \left[\frac{(14.0\% - 4.0\%)}{14.0\%} \right] = 71.4\% \text{ report } 71\%$$

Effective Specific Gravity of the Aggregate (Stone) (G_{sc})

$$G_{se} = \frac{P_s}{\left[\left(\frac{100}{G_{mm}}\right) - \left(\frac{P_b}{G_b}\right)\right]}$$

$$G_{se} = \frac{(100 - 4.60\%)}{\left[\left(\frac{100}{2.516}\right) - \left(\frac{4.60\%}{1.020}\right)\right]}$$

$$G_{se} = \frac{95.40\%}{39.74563 - 4.50980} = 2.70747 \text{ report } 2.707$$

Given:

$$G_b = 1.020$$

Percent of Absorbed (asphalt) Binder (P_{ba})

$$P_{ba} = 100 \left[\frac{(G_{se} - G_{sb})}{(G_{sb} \times G_{se})} \right] G_b$$

$$P_{ba} = 100 \left[\frac{(2.707 - 2.678)}{(2.678 \times 2.707)} \right] 1.020 =$$

$$P_{ba} = 100 \left[\frac{0.0290}{7.24935} \right] 1.020 = 0.40804\% \text{ report } 0.41\%$$

Percent of Effective (asphalt) Binder (P_{be})

$$P_{be} = P_b - \left[\frac{P_{ba}}{100} \times P_s \right]$$

$$P_{be} = 4.60 - \left[\frac{0.41\%}{100} \times (100 - 4.60\%) \right] = 4.20886\% \text{ report } 4.21\%$$

Dust Proportion – DP (Dust to Effective (asphalt) Binder Ratio)

$$DP = \frac{P_{\#200}}{P_{be}}$$

$$DP = \frac{4.9\%}{4.21\%} = 1.16390 \text{ report } 1.16$$

Given:

$$P_{\#200} = 4.9\%$$

Report

- On forms approved by the agency
- Sample ID
- Air Voids, V_a to the nearest 0.1 percent
- Voids in the Mineral Aggregate, VMA to the nearest 0.1 percent
- Voids Filled with Asphalt, VFA to the nearest whole value

- Effective Specific Gravity of Aggregate (stone), G_{sc} to the nearest 0.001
- Percent of Absorbed (asphalt) Binder, P_{ba} to the nearest 0.01
- Percent Effective (asphalt) Binder, P_{be} to the nearest 0.01
- Dust Proportion, DP to the nearest 0.01

APPENDIX - FORMULAS

Air Voids (V_a)

$$V_a = 100 \left[\frac{(G_{mm} - G_{mb})}{G_{mm}} \right]$$

Where:

- V_a = air voids in compacted mixture, percent of total volume (report to 0.1)
- G_{mm} = maximum specific gravity of paving mixture (AASHTO T 209)
- G_{mb} = bulk specific gravity of compacted mixture (AASHTO T 166)

Percent Aggregate (Stone) (P_s)

$$P_s = 100 - P_b$$

Where:

- P_s = percent aggregate (stone) percent by total weight
- P_b = asphalt binder content (AASHTO T 308)

Voids in the Mineral Aggregate (VMA)

$$VMA = 100 - \left[\frac{(G_{mb} \times P_s)}{G_{sb}} \right]$$

Where:

- VMA = voids in mineral aggregate, percent of bulk volume (report to 0.1)
- G_{sb} = bulk specific gravity of combined aggregate (AASHTO T 85 / T 84 or agency approved method from Job Mix Formula)
- G_{mb} = bulk specific gravity of compacted mixture (AASHTO T 166)
- P_s = aggregate content, percent by total weight = 100 - P_b
- P_b = asphalt binder content (AASHTO T 308) percent by total weight

Voids Filled with Asphalt (binder) (VFA)

$$VFA = 100 \left[\frac{(VMA - V_a)}{VMA} \right]$$

Where:

- VFA = voids filled with asphalt, percent of VMA (report to 1)
- VMA = voids in mineral aggregate, percent of bulk volume
- V_a = air voids in compacted mixture, percent of total volume.

Effective Specific Gravity of the Aggregate (Stone) (G_{se})

$$G_{se} = \frac{P_s}{\left[\left(\frac{100}{G_{mm}} \right) - \left(\frac{P_b}{G_b} \right) \right]}$$

Where:

- G_{se} = effective specific gravity of combined aggregate (report to 0.001)
- P_s = aggregate content, percent by total weight = 100 - P_b
- G_{mm} = maximum specific gravity of mix (AASHTO T 209)
- P_b = asphalt binder content (AASHTO T 308) percent by total weight

G_b = specific gravity of asphalt binder (JMF or asphalt binder supplier)

Percent of Absorbed (asphalt) Binder (P_{ba})

$$P_{ba} = 100 \left[\frac{(G_{se} - G_{sb})}{(G_{sb} \times G_{se})} \right] G_b$$

Where:

P_{ba} = absorbed asphalt binder (report to 0.01) percent of aggregate

G_{se} = effective specific gravity of combined aggregate

G_{sb} = bulk specific gravity of combined aggregate (AASHTO T 85 from Job Mix Formula)

G_b = specific gravity of asphalt binder (JMF or asphalt binder supplier)

Percent of Effective (asphalt) Binder (P_{be})

$$P_{be} = P_b - \left[\frac{P_{ba}}{100} \times P_s \right]$$

Where:

P_{be} = effective asphalt binder content (report to 0.01), percent by total weight

P_s = aggregate content, percent by total weight = $100 - P_b$

P_b = asphalt binder content (AASHTO T 308) percent by total weight

P_{ba} = absorbed asphalt binder

Dust Proportion – DP (Dust to Effective (asphalt) Binder Ratio)

$$DP = \frac{P_{-200}}{P_{be}}$$

Where:

DP = Dust Proportion, (dust-to-binder ratio) (report to 0.01)

P_{-200} = aggregate passing the -#200 (75 μ m) sieve, percent by mass of aggregate (AASHTO T 30)

P_{be} = effective asphalt binder content, percent by total weight

This page intentionally left blank.

ATM 417 Asphalt Mixture Design by the Marshall Method

1. Scope

This method describes the Marshall Mix Design procedure for determining the optimum asphalt content, stability, flow and void properties of hot Asphalt Mixtures containing; aggregates with maximum sizes of (1") or less, Recycled Asphalt Pavements (RAP), mixes utilizing rubber, and Warm Mix Asphalt (WMA). This method is adapted from the Asphalt Institute "Mix Design Methods for Asphalt Concrete and Other Hot Mix Types", Manual Series No. 2 (MS-2). It also includes information and procedures from AASHTO T 245 and AASHTO R 30 Apparatus

2. Significance

Aggregate properties important to Asphalt Mixtures shall be determined as required. For Asphalt Mixtures this will include: gradation of each submitted aggregate and, after combining according to the proposed Job Mix Formula (JMF), the plasticity index, fracture, flat & elongated, and bulk specific gravity of the coarse & fine aggregate. For Stone Mastic Asphalt (SMA) mixes, in addition to the tests listed for Asphalt Mixtures, the unit mass of the combined coarse aggregate and the apparent specific gravity of the mineral filler will be required.

A minimum of four (4) sets of three (3) specimens each, shall be prepared, mixed and compacted at different asphalt contents. These asphalt contents shall be by mass of total mix and will be at 0.5 percent increments. These specimens will be tested for Unit Mass, Marshall Stability & Flow, Percent Air Voids in Total Mix (VTM), Percent Voids in Mineral Aggregate (VMA), Percent Voids Filled with Asphalt (VF), and (for SMA mixes) Voids in Coarse Aggregate (VCA). The final results will define the VTM over that parameters specification range and should define the maximum values of the Stability and Unit Mass of the mix and the minimum value for VMA.

Three (3) specimens shall be prepared, mixed and tested to determine the maximum specific gravity in accordance with WAQTC FOP for AASHTO T 209.

Calibration specimens will be prepared as required by the Acceptance testing program for the project. The calibrations may include any of the following:

- JMF Calibration Points for the Nuclear Asphalt Content Gauge for ATM 405.
- Ignition Furnace Calibration Points for each Ignition Furnace System for WAQTC FOP for AASHTO T 308.

When RAP is incorporated in the mix design, an extraction device as described in AASHTO T 164 is required to determine the asphalt content and the aggregate properties of the RAP proposed for use in the mix. The contractor will submit asphalt content and gradations from 10 representative samples collected from the proposed RAP source. The contractor will submit 3 representative samples to be tested for verification of the contractors asphalt content and gradation properties for the stockpile.

3. Apparatus

- Ovens and hot plates thermostatically controlled to maintain the various required temperatures within $\pm 3^{\circ}\text{C}$ (5°F).
- Temperature measuring devices:
- For asphalt cement and mixes: having a range of $10\text{-}200^{\circ}\text{C}$ ($50\text{-}400^{\circ}\text{F}$) and sensitive to 3°C (5°F).
- For the water bath: readable and sensitive to $\pm 0.2^{\circ}\text{C}$ (0.5°F) at 60°C (140°F).
- Balance or scale: Capacity sufficient for the principal sample mass, readable to 0.1 percent or 0.1 g of the total sample mass and meeting the requirements of AASHTO M 231.

- Sieve shaker meeting the requirements of WAQTC FOP for AASHTO T 27/T 11.
- Mechanical mixer with a wire whip mixing blade capable of producing a well coated, homogeneous mixture and mixing bowls. Means of maintaining the mixture at mixing temperature, such as a heat lamp mounted below the mixer.

Note 1: The Hobart Kitchen Aid Model K-5A with wire whip Model K5A-WW has been found satisfactory.

- The mold assemblies, compaction pedestal, mold holder, extruder, breaking head and flow meter or stress-strain recorder shall conform to AASHTO T 245.
- If rubber is being used in the mix, weights of at least 5 lbs. in mass and slightly smaller than 4-inches in diameter will be required. The weights should be of such diameter to loosely fit inside the 4-inch Marshall molds.
- Mechanical compaction device conforming to AASHTO T 245. The device shall be equipped with a counter that will automatically shut off the machine at the required number of blows. The device will be calibrated annually in accordance with ASTM D 2168.
- Paper discs of heavy weight non-absorbent paper stock, 100 mm (4") diameter.

Note 2: The Humboldt H-1341P paper disc has been found satisfactory.

- If rubber is being used in the mix, substitute acetate discs for the paper discs. Hewlett Packard overhead transparency film (HP 92296T) has been found to work well.
- The water bath shall be at least 150 mm (6") deep and shall be thermostatically controlled so as to maintain a temperature of $60 \pm 1^\circ\text{C}$ ($140 \pm 1.8^\circ\text{F}$). The bath shall be equipped with an agitator to keep the water in constant circulation. It shall have a perforated false bottom or shelf for supporting the specimens a minimum of 2" (50 mm) above the bottom of the bath. The bath shall have a flat surface area large enough to allow the specimens to set singly with water flowing freely around each specimen. Stacking specimens is prohibited.
- Loading jack consisting of either a motor-driven screw jack, a hydraulic jack or other mechanical loading device which shall produce a uniform loading head movement rate of 50 mm (2") per minute, independent of the load being applied. The loading frame shall have a minimum load capacity of 25 KN (5000 lb.).
- Load measuring device of 25 KN (5000 lb.) minimum capacity, sensitive to 50 N (10 lb.) or less, and capable of measuring displacement to 0.0025 mm (0.0001"). This device may be a load-cell or a ring dynamometer assembly.
- Flowmeter—the flowmeter shall consist of a guide sleeve and a gage. The activation pin of the gage shall slide inside the guide sleeve with a slight amount of frictional resistance. The guide sleeve shall slide freely over the guide rod of the breaking head. The flowmeter gage shall be adjusted to zero when placed in position on the breaking head when each individual test specimen is inserted between the breaking head segments. Graduations of the flowmeter gauge shall be in 0.25 mm (0.01") divisions.
- Data measuring/recording/display devices capable of the capacity and sensitivity of the load-measuring device and or flowmeter.
- Miscellaneous equipment including scale or caliper readable to 0.25 mm (0.01"), sample containers (metal pans, bowls or beakers), spatulas, spoons, marking crayons, heat resistant gloves, straight-edge, etc.
- **Asphalt Mixture** Design Worksheet, Bituminous Mix Design Report, and 0.45 Gradation Chart paper.

4. Determination of Asphalt Cement Properties

1. If not provided by the supplier, determine the following: Verify compliance of the asphalt binder plus additives to specifications; in addition, determine the specific gravity at 25°C (77°F) of the asphalt binder in accordance with AASHTO T 228/ASTM D 70.
2. Establish the temperature-viscosity properties of the cement in accordance with ASTM D 2493 with the viscosities determined in accordance with the following as required by the project specifications:

AASHTO T 201 & T 202
ASTM D 2170 & D 2171

Or

AASHTO T 315 & T 316

3. Select the mixing and compaction temperatures using the temperature-viscosity data. Determine, unless otherwise specified, the mixing temperature at 170 ± 20 centistokes and the compaction temperature at 280 ± 30 centistokes.

Note 3: Modified asphalts may not adhere to the equiviscosity requirements noted; the manufacturer's recommendations should be requested and used to determine mixing and compaction temperatures. Practically the mixing temperature should not exceed 165°C (330°F) and the compaction temperature should not be lower than 115°C (240°F).

5. Determination of Rubber Properties

1. Perform a gradation of the rubber product in accordance with WAQTC FOP for AASHTO T 27/T 11. Washing is not required.
2. Obtain the specific gravity of the rubber from the manufacturer.

6. Preparation of Aggregate

The aggregates used for the mix design will represent the aggregates in the contractor's stockpiles. The laboratory will use the aggregate as presented by the contractor and prepare the aggregate in the same manner as it will be handled during production. In no event will the aggregate be washed in the preparation of any test specimens other than the dust correction procedure.

RAP shall be considered an aggregate for the purposes of batching material. The oil content of RAP will be considered asphalt cement. Virgin aggregate and cement will be adjusted accordingly. Dry RAP at temperatures less than 60°C prior to use. RAP will be added to the aggregate at time of batching.

1. Mix the aggregates from the individual stockpiles at the blend ratio specified by the contractor.

Separate the combined aggregates by dry sieving into individual specification sieve sizes including the minus 75 µm (No. 200) material. As the material is being dry sieved, separation will not be as efficient as when using washed samples. Therefore sieving time must be increased to separate as efficiently as possible. Sieving times should be increased to 15 minutes for coarse aggregate separation and 15-20 minutes for fine aggregate. The increased sieving time may be determined in accordance with WAQTC FOP for AASHTO T 27/T 11 (See Note 5).

Separate sufficient aggregate to perform all required tests (i.e. Marshall Stability, Calibration Points for Nuclear Content Gauge, Ignition Furnace, and aggregate properties as required).

2. Using the contractor proposed gradation calculate the initial cumulative masses for each specification sieve size by the following:

$$X = \frac{(100 - P_N)}{100} \times E_i$$

Where:

- X = Cumulative aggregate batch masses for sieve size N, record to the nearest 1 g,
- P_N = Percent passing from proposed gradation for sieve size N, and
- E_i = Initial total aggregate mass for a Marshall specimen.

Note 4: The initial aggregate mass may be chosen based on experience or a mass such as 1200 g may be assumed at this point. If a mass is assumed, a trial specimen to determine if height adjustment in accordance with the methodology of Preparation of Test Specimens, Step 1 a thru c will be required.

3. Aggregate Batching Correction:

As the JMF gradation was determined in accordance with WAQTC FOP for AASHTO T 27/T 11, which washed the sample in some manner, and the material for the mix design has been separated by dry sieving which will not completely separate the aggregate, a correction must be made to the material separated for the mix design to ensure that the proper amount of aggregate but especially the minus 75 µm (No. 200) material is included in the test specimens. If this is not done, batching material in accordance with the methodology outlined in this method will result in the mix design having a higher percentage of aggregate, fine sand and/or silt than the contractor's JMF proposes.

- a. Prepare a wash gradation sample.

Calculate the initial batch masses for the wash gradation.

- b. Perform a wash gradation in accordance with WAQTC FOP for AASHTO T 27/T 11.
- c. Compute the adjusted cumulative batch masses for each of the sieve sizes by the following formula:

$$Z_{Ni} = \frac{X^2}{Y}$$

Where:

- Z_{Ni} = corrected cumulative batch mass for sieve size N,
- X = pre-wash cumulative batch mass for sieve size N,
- Y = post-wash cumulative batch mass for sieve size N.

Note 5: In some cases, the adjusted cumulative batch masses will result in decreasing batch masses instead of increasing batch masses. This indicates that the dry sieving operation did not efficiently separate the fine aggregate, leaving too much 75 µm (No. 200) and minus 75 µm (No. 200) material in the larger aggregate sizes. If this occurs, resieve the sizes showing the decreasing batch masses, combining the separated material with the material already separated and perform Step 6.3 a thru c again.

- d. Tabulate the overall adjusted cumulative batch.

4. Prepare samples from the separated aggregate for the determination of the:

- a. Plastic Index in accordance with WAQTC FOP for AASHTO T 90,
- b. Percentage of Fracture in Coarse Aggregate in accordance with WAQTC FOP for AASHTO T 335,
- c. Unit weight of fine and coarse aggregate in accordance with T 84 and WAQTC FOP for AASHTO T 85 respectively,
- d. Flat and elongated Particles in accordance with ATM 306, if required, and
- e. Sand Equivalent in accordance with WAQTC FOP for AASHTO T 176, if required.

7. Estimate Projected Optimum Asphalt Binder and Rubber Content

1. Estimate the projected optimum asphalt binder content. This value can be based on any or all of these sources:

2. Experience. This is the most important method of estimating projected optimum asphalt content. The projected optimum asphalt binder content will be estimated to the nearest 0.5 percent with four (4) sets of three (3) specimens prepared to bracket the projected optimum at 0.5 percent intervals.
3. The following methods may be used where no experience exists for the proposed material and/or JMF target values.
4. Computational formula:

$$P = 0.035 a + 0.045 b + K c + F$$

Where:

- P = projected optimum asphalt content of mix, percent by mass of mix,
- a = percent retained on the 2.36 mm (No. 8) sieve, expressed as a whole number
- b = percent passing the 2.36 mm (No. 8) sieve minus the percent passing on the 75 μm (No. 200) sieve, expressed as a whole number
- c = percent passing the 75 μm (No. 200) sieve, expressed to the 0.1 percent
- K = 0.15 for 11 to 15 percent passing the 75 μm (No. 200) sieve, or
= 0.18 for 6 to 10 percent passing the 75 μm (No. 200) sieve, or
= 0.20 for 5 percent or less passing the 75 μm (No. 200) sieve, and
- F = asphalt binder absorption. In the absence of other data, use 0.7 percent.

The projected optimum asphalt binder content will be rounded to the nearest 0.5 percent with specimens prepared as indicated under step 1.a.

5. Dust-Asphalt Ratio: Since the Dust-Asphalt Ratio specification is typically 0.6 to 1.2, using the larger of the D/A limits will give the projected minimum effective asphalt content for the JMF p200 target. Solving the Dust-Asphalt ratio formula for the projected minimum asphalt content percent (effective asphalt binder content plus absorbed asphalt binder):

$$\text{Max.} \quad D/A = \left(\frac{p200}{P} \right)$$

$$\text{for } P \text{ results in} \quad P = \left(\frac{p200}{\text{Max. } D/A} \right)$$

Where:

- P = projected minimum effective asphalt binder content of mix, percent by mass of mix,
- p200 = percent passing the 75 μm (No. 200) sieve, and
- Max. D/A = dust-to-asphalt ratio.

The total projected asphalt binder content may be estimated by:

$$P_m = P + F$$

Where:

- P_m = projected minimum asphalt binder content, percent
- P = projected minimum effective asphalt binder content of mix, percent
- F = asphalt binder absorption, percent. In the absence of other data use 0.7 percent.

6. Percent rubber will be determined by the Regional Materials Engineer. Rubber will be calculated as a percent of aggregate.

This projected minimum asphalt **binder** content will be rounded to the nearest 0.5 percent with specimens prepared for at this projected minimum value and at least three (3) more above this value at 0.5 percent intervals.

8. Preparation of Test Specimens

1. Marshall Stability and Flow: Batch a minimum of four (4) sets of three (3) aggregate specimens each. However, if the initial total aggregate mass for the Marshall specimen was estimated without prior experience, a single Marshall specimen will be batched, mixed at the projected optimum asphalt **binder** content, compacted and the thickness of the compacted specimen measured to determine if the aggregate mass must be adjusted. If rubber is used in the mix it will be added at this time.

a. Thickness Adjustment

- (1) The height of the compacted specimen must be within the specimen thickness limitations of 62-65 mm (2.45-2.55"). If it is not, adjust the total mass of the aggregate as shown below and recalculate the individual sieve masses to bring the specimens within this range.
- (2) Prepare an aggregate batch to the masses calculated above and calculate the mass of asphalt required for the estimated optimum asphalt **binder** content as shown below. Mix and compact the trial specimen in accordance with the requirements of **sections 9 and 11**.
- (3) If thickness adjustment is necessary, adjust E_i , the initial total aggregate mass, by the following:

$$E_a = \frac{2.5 \times E_i}{H} \text{ (USC) or } \frac{63.5 \times E_i}{H} \text{ (SI)}$$

Where:

- E_a = adjusted total aggregate mass,
- E_i = initial total aggregate mass, and
- H = specimen thickness 0.1 mm (0.01") actually obtained.

- (4) If necessary, adjust each Z_{Ni} from Step 6.3c by:

$$Z_{Na} = \frac{E_a}{E_i} \times Z_{Ni}$$

Where:

- Z_{Na} = adjusted cumulative batch mass for sieve size N,
- E_a = adjusted total aggregate mass,
- E_i = initial total aggregate mass,
- Z_{Ni} = corrected cumulative batch mass for sieve size N.

- (5) Using either the corrected cumulative sieve masses (Z_{Ni}) determined in **Preparation of Aggregate**, Step 6.4c or the adjusted cumulative sieve masses (Z_{Na}) determined in Step 1a, above, prepare three (3) aggregate specimens for each asphalt content. The aggregate for each specimen will be batched and placed in a container and dry-mixed thoroughly.

- b. Calculate the mass of the asphalt **binder** for each set of specimens by:

$$AW = \frac{E_i \text{ (or } E_a) \times P_{bN}}{100 - P_{bN}}$$

Where:

- AW = mass of asphalt **binder** to the nearest 0.1 g,
- E_i (or E_a) = initial (or adjusted, see below) aggregate mass, and

P_{bN} = asphalt binder content for set N, to the nearest 0.1 percent.

2. Maximum Specific Gravity of Mixture.

- a. For each sieve size, calculate the cumulative masses for a maximum specific gravity (Rice) test specimen by the following formula:

$$R_N = \frac{Q}{E_i} \times Z_{Ni}$$

Where:

- R_N = cumulative batch mass for the maximum specific gravity specimen for sieve size N,
- E_i = initial total aggregate mass,
- Z_{Ni} = corrected cumulative batch mass for sieve size N, and
- Q = minimum sample mass required by WAQTC FOP for AASHTO T 209.

- b. Prepare three (3) test specimens to these masses for performance of WAQTC FOP for AASHTO T 209.

3. Coarse Aggregate Properties.

- a. For each coarse aggregate sieve size, calculate the cumulative masses for the required test specimens of coarse aggregate for the required test procedures by the following formula:

$$C_N = \frac{Q}{\text{No. 4 } Z_N} \times Z_{Ni}$$

Where:

- C_N = cumulative batch mass for the maximum specific gravity specimen for sieve size N, for the 4.75 mm (No. 4) and larger sieves only,
- Q = minimum sample mass required for the required tests.
- $\text{No. 4 } Z_N$ = initial total aggregate mass of 4.75 mm (No. 4), and
- Z_{Ni} = adjusted cumulative batch mass for sieve size N.

- b. Prepare the required number of test specimens to the minimum sample size required by the test procedure for the performance of the following or other specified tests as required:

Test Procedure		
Designation	Title	Number of Specimens
WAQTC FOP for AASHTO T 85	Specific Gravity	1
WAQTC FOP for AASHTO T 335	Fracture	1
ATM 306	Flat-Elongated	1
AASHTO T 19 (SMA only)	Bulk Density	3

4. Fine Aggregate Properties.

- a. For each fine aggregate sieve size, calculate the cumulative masses for the specific fine aggregate property test by the following formula:

$$F_N = \left(\frac{Q}{E_i - Z_{4i}} \right) \times (Z_{Ni} - Z_{4i})$$

Where:

- F_N = cumulative batch mass for the fine aggregate specific gravity specimen for sieve size N, for the minus 4.75 mm (No. 4) sieves only,
- Q = sample mass required for the specified test,
- E_i = initial total aggregate mass,
- Z_{Ni} = initial cumulative batch mass for sieve size N, and
- Z_{4i} = initial cumulative batch mass for the 4.75 mm (No. 4) sieve.

- b. Prepare the required number of test specimens to the minimum sample size required by the test procedure for the performance of the following or other specified tests as required:

Test Procedure		Number of Specimens
Designation	Title	
WAQTC FOP for AASHTO T 90	Plastic Index	1
AASHTO T 84	Specific Gravity	3
WAQTC FOP for AASHTO T 176	Sand Equivalent	1

5. Mineral Filler Specific Gravity.

If the JMF p200 is greater than 6 percent, the minus 75 μ m (No. 200) material will be treated as mineral filler and the apparent specific gravity of this material will be determined in accordance with AASHTO T 100.

9. Preparation of Asphalt Binder

Heat a minimum of 1 L (1 qt.) of asphalt binder to the mid-point of the mixing temperature range.

It is best to use the asphalt binder as soon as it reaches mixing temperature. If this is not possible, maintain the asphalt binder at this temperature in a covered container rather than reheat it.

10. Preparation of Mixtures and Mixture Conditioning

1. Place the aggregate specimens for Marshall Stability & Flow and Maximum Specific Gravity in the oven and heat to the mid-point of the asphalt binder mixing temperature range.
2. "Butter" the mixing bowl with asphalt binder and fine aggregate mixture that will coat the mixing area of the bowl. Remove any excess material.
3. Place the heated specimen into the mixing bowl.
4. Form a crater in the dry blended aggregate large enough to hold the asphalt cement, place the mixing bowl on the scale and weigh into the aggregate crater, to the nearest 0.1 g, the required amount of pre-heated asphalt binder.
5. Mechanically mix the aggregate and asphalt binder rapidly until thoroughly coating the aggregate and return to the oven.
6. After mixing, spread the mixture in a pan to an even thickness of 25-50 mm (1-2 inches). Place the mixture and pan in a forced-draft oven at the midpoint of the compaction temperature range for 120 ± 5 minutes. Stir the mixture after 60 ± 5 minutes to maintain uniform conditioning. Highly absorptive aggregates may require a longer conditioning time.

11. Equipment Preparation

1. Thoroughly clean the mold assemblies (molds, bases and collars) and heat in an oven to the mid-point of the asphalt cements compaction temperature range.
2. Thoroughly clean the face of the compaction hammer and heat on a hot plate to a temperature within the asphalt cements compaction temperature range.

12. Compaction of Specimens

1. Place the pre-heated mold assembly into the mold holder on the compaction pedestal. Place a paper disc, or acetate disc if rubber is used in mix, in the bottom of the mold.
2. Stir the specimen thoroughly and place in the mold. Spade the mixture vigorously with a heated spatula 15 times around the perimeter and 10 times over the interior, remove the collar and smooth the surface of the mix to a slightly rounded shape.
3. Place a paper disc, or acetate disc if rubber is used in mix, on top of the specimen, position the compaction hammer, and apply the required number of blows with the compaction hammer.
4. Remove the base plate and collar, invert and re-assemble the mold, and apply the same number of blows to the face of the inverted specimen.
5. Remove the collar, base plate and paper discs, mark each biscuit for individual identification, and allow them to cool until the specimen can be extruded without damage or distortion.
6. If rubber is used in the mix, do not remove the base plate or acetate discs. Place a minimum 5 lb. mass on top of specimen and let stand 24 hours. After 24 hours remove weight.
7. Extrude the specimen from the mold; transfer to a smooth, flat surface; allow it to stand and cool to room temperature. Acetate discs can be removed at this point. Specimens can be placed on a hot plate for a few seconds to facilitate removal.

13. Mix Sample Test Procedures

1. Measure and record the thickness of each compacted specimen and record to the nearest 0.25 mm (0.01"). Use either a device that will measure the average height or measure the height with a caliper at three (3) locations spaced evenly around the circumference of the specimen and average these results.
2. Determine the bulk specific gravity of each compacted specimen in accordance with WAQTC FOP for AASHTO T 166/T 275.
3. Stability and Flow.
 - a. Bring the specimens to the specified temperature of $60 \pm 1^{\circ}\text{C}$ ($140 \pm 1.8^{\circ}\text{F}$) by immersing in the water bath for 30 to 40 minutes. Stacking specimens on top of each other is prohibited.
 - b. Thoroughly clean and lubricate the guide rods, and clean the inside surfaces of the breaking heads before performing the stability and flow tests. Maintain the breaking head at a temperature of 21 to 38°C (70 to 100°F).
 - c. Remove the specimens one at a time from the water bath and place in the lower segment of the breaking head.
 - d. Place the upper segment of the breaking head on the specimen, firmly seat the head on the specimen, and place the complete assembly in position on the loading jack.

The elapsed time for the test from the removal of the test specimen from the water bath to the maximum load determination shall not exceed 30 seconds.

e. For machines using proving ring & flow meter:

- (1) Place the flow meter over one of the guide rods and adjust the flow meter to zero; hold the sleeve firmly against the upper segment of the breaking head while the test load is applied.
- (2) Load the specimen at a constant rate of 50.8 mm (2") per minute until the maximum load is reached. The maximum load is indicated when the proving ring dial value decreases.
- (3) Simultaneously read the proving ring dial to the nearest 0.0025 mm (0.0001") and the flow meter to the nearest 0.25 mm (0.01"). Record the readings as whole numbers (no decimal points) from the proving ring dial flow meter.

f. For machines using load cell and chart recorder/display:

- (1) Turn on the recorder, adjust the pen to the zero position according to the manufacturer's instructions, turn the range selector to the appropriate range (use the smallest range possible) and set the chart speed at 10" per minute (250 mm per minute).
- (2) Apply the load to the specimen by means of the constant rate movement of the loading jack at 50 mm per minute (2" per minute) until the maximum is reached and the load, as indicated by the chart recorder, decreases.

4. Maximum Specific Gravity.

Determine the maximum specific gravity of the prepared specimens at or near the optimum asphalt binder content in accordance with WAQTC FOP for AASHTO T 209 as follows:

- a. Choose a projected optimum asphalt binder content as described in **Estimate Projected Optimum Asphalt Binder Content**.
- b. Mix and condition the specimens in accordance with the provisions of **Preparation of Mixtures and Mixture Conditioning**.
- c. Determine the maximum specific gravity in accordance with WAQTC FOP for AASHTO T 209 on the prepared specimens at the projected optimum asphalt content.
- d. If the projected optimum asphalt binder content differs from the final optimum asphalt content, determined below in **Determination of Optimum Asphalt Binder Content, Selection of Final Optimum Asphalt Binder Content**, by 1 percent or more, prepare and determine a new maximum specific gravity at the final optimum asphalt binder content and recalculate the maximum specific gravities at the other asphalt Binder contents, the voids total mix and the optimum asphalt binder content.

14. Calculations

1. Calculate the bulk specific gravity of each compacted specimen in accordance with WAQTC FOP for AASHTO T 166/T 275. Average the bulk specific gravities (G_{mb}) of all compacted specimens for each asphalt binder content.
 - Record the result to the nearest 0.001.
2. Calculate the unit weight for each asphalt binder content by:

$$W_N = G_{mbN} \times 997.1 \text{ kg/m}^3 \text{ (62.245 lb/ft}^3\text{)}$$

Where:

W_N = unit weight of set N,

G_{mbN} = average bulk specific gravity of set N, and 997.1 kg/m^3 (62.245 lb/ft^3) = density of water at 25°C (77°F).

- Record the result to the nearest 1 kg/m³ (0.1 lb/ft³).
- Calculate the maximum specific gravity of the mix at the selected asphalt content in accordance with WAQTC FOP for AASHTO T 209. Average the results and record the average to the nearest 0.001.
 - Calculate the maximum specific gravity for each asphalt binder content as follows:
 - Calculate the effective specific gravity of the aggregate by:

$$G_{se} = \frac{100 - P_b}{\frac{100}{G_{mm}} - \frac{P_b}{G_b}}$$

Where:

- G_{se} = effective specific gravity of the aggregate,
- P_b = asphalt content at which G_{mm} was determined,
- G_{mm} = maximum specific gravity at P_b ,
- G_b = specific gravity of the asphalt at 25 °C (77°F).

- Record the result to the nearest 0.001.
- Calculate the maximum specific gravity for each asphalt binder content by:

$$G_{mm} = \frac{100}{\frac{100 - P_{bN}}{G_{se}} + \frac{P_{bN}}{G_b}}$$

Where:

- G_{mm} = maximum specific gravity for asphalt binder content P_{bN} ,
- G_{se} = effective specific gravity of the aggregate,
- P_{bN} = percent asphalt binder for set N, and
- G_b = specific gravity of the asphalt binder at 25 °C (77°F).

- Record the result to the nearest 0.001.
- Calculate the percent air voids in total mix (VTM) for each asphalt binder content by:

$$VTM = \frac{G_{mm} - G_{mb}}{G_{mm}} \times 100$$

Where:

- VTM = percent voids total mix,
- G_{mb} = average specific gravity of each content, and
- G_{mm} = maximum specific gravity of each content.

- Record the result to the nearest 0.1 percent.
- Calculate the percent voids in mineral aggregate (VMA) for each asphalt content by:
 - Calculate the blended aggregate bulk specific gravity by:

$$G_{sb} = \frac{100}{\frac{P_1}{G_1} + \frac{P_2}{G_2} + \dots + \frac{P_N}{G_N}}$$

Where:

- G_{sb} = blended aggregate bulk specific gravity,
- P_1, P_2, \dots, P_N = percent of individual aggregate,
- $G_1, G_2 \dots G_N$ = bulk specific gravity individual aggregate.

- Record the result to the nearest 0.001.

b. Calculate the percent voids in mineral aggregate for each asphalt content by:

$$VMA = 100 - \frac{G_{mb} (100 - P_b)}{G_{sb}}$$

Where:

- VMA = percent voids in mineral aggregate for each content,
- G_{sb} = blended aggregate bulk specific gravity,
- G_{mb} = average bulk specific gravity for each asphalt binder content, and
- P_b = percent asphalt binder of each content.

- Record the result to the nearest 0.1 percent.

7. Calculate the percent voids filled with asphalt (VFA) for each asphalt content by:

$$VFA = 100 \times \frac{VMA - VTM}{VMA}$$

Where:

- VFA = percent voids filled with asphalt for each content,
- VMA = percent Voids in mineral aggregate for each binder content, and
- VTM = percent voids total mix for each content.

- Record the result to the nearest whole percent.

8. Calculate the dust/asphalt ration for each asphalt content by:

a. Calculate the asphalt absorption by:

$$P_{ba} = 100 \left(\frac{G_{se} - G_{sb}}{G_{sb} \times G_{se}} \right) G_b$$

Where:

- P_{ba} = absorbed asphalt, percent by mass of aggregate,
- G_{se} = effective specific gravity of aggregate,
- G_{sb} = bulk specific gravity of aggregate, and
- G_b = specific gravity of asphalt binder.

b. Calculate the effective asphalt binder content for each asphalt content by:

$$P_{be} = P_b - \left(\left(\frac{P_{ba}}{100} \right) \times (100 - P_b) \right)$$

Where:

- P_{be} = effective asphalt binder content, percent by total mass of mix,
- P_b = asphalt binder content, percent by total mass of mix, and
- P_{ba} = absorbed asphalt binder, percent by mass of aggregate.

- c. Calculate the dust/asphalt ratio by:

$$D/A = \frac{p_{200}}{P_{be}}$$

Where:

- D/A = dust/asphalt ratio,
 p₂₀₀ = percent passing the 75 μm (No. 200) sieve, and
 P_{be} = effective asphalt binder content, percent by total mass of mix.

9. Stability:

- a. For machines using proving ring and flow meter, calculate the uncorrected stability from the dial readings by the following:

$$S = (D \times m) + C$$

Where:

- S = uncorrected stability load, in pounds,
 D = dial reading as a whole number
 m = slope from proving ring calibration, and
 C = constant from proving ring calibration.

- Record the result to the nearest whole pound.

- b. For machines using load cell and chart recorder/display, read and record the uncorrected stability to the accuracy allowed by the chart scale.

- c. Stability values for each specimen that differ from the standard 63.5 mm (2.5") thickness will be corrected to the equivalent 63.5 mm (2.5") value by the following:

$$CS = S \times t$$

Where:

- CS = corrected stability,
 S = uncorrected stability, and
 t = thickness correction factor = -0.64x + 2.6 for x in inches or -0.025x + 2.5875 for x in mm. (Equations derived from data presented in Table 2 of AASHTO T 245 for thicknesses from 2.4375" to 2.5625" (61.9 mm to 65.1 mm).

- d. Corrected stability values for each asphalt content averaged and recorded to the nearest 50 N (10 lb).

Table 1

Thickness Correction Factors

Inches	mm	t-Correction Factor
2.45	62.2	1.03
2.46	62.5	1.03
2.47	62.7	1.02
2.48	63.0	1.01
2.49	63.2	1.01
2.50	63.5	1.00
2.51	63.8	0.99

Inches	mm	t-Correction Factor
2.52	64.0	0.99
2.53	64.3	0.98
2.54	64.5	0.97
2.55	64.8	0.97

Table based on data from AASHTO T 245 Table 2

10. Flow:

- a. For machines using the proving ring and flow meter, average the flow values for each asphalt content and record as a whole number (e.g. flow reading of 0.12 will be recorded as 12).
- b. For machines using load cell and chart recorder:
 - (1) Extend the constant rate slope line to intersect the horizontal axis.
 - (2) Determine the maximum load point and draw a line perpendicular to the horizontal axis through this point to intersect the horizontal axis.
 - (3) From the point determined in (1) to the point determined in (2), read and record the flow as a whole number in 0.01" increments.
 - (4) Average the flow values for each asphalt content set and record to the nearest whole number.

15. Determination of Optimum Asphalt Binder Content

For a mix to satisfy a specific project specifications graphical presentation of the results should be prepared prior to the selection of the optimum asphalt binder content.

Graphical Presentation:

Prepare a graphical plot of Asphalt Binder Content vs. Unit Weight, Stability, Flow, Percent Voids Total Mix, Percent Voids in Mineral Aggregate, and Percent Voids Filled with a smooth curve that represents a best-fit for all values.

Determination of Optimum Asphalt Content:

1. **Determination of Preliminary Optimum Asphalt Binder Content:** Choose the preliminary optimum asphalt binder content at the median of the Voids in Total Mix specification. All of the calculated and measured mix properties should then be evaluated by comparing them to the project mix design specifications. If all of the specifications are met, then this is the preliminary optimum asphalt binder content. If all of the specifications are not met, then some adjustment or compromise is necessary or the mix may need to be redesigned. Even if all of the specifications are met, a number of considerations should be evaluated before choosing the final optimum asphalt binder content.
2. **Selection of Final Mix Optimum Asphalt Binder Content:** The final optimum asphalt binder content should be a compromise selected to balance all of the mix properties. Normally, the mix design specifications will produce a narrow range of acceptable asphalt binder contents that will pass all specifications. The asphalt binder content selection can be adjusted within this narrow range to achieve establishing the final optimum asphalt binder content. Establishing a final optimum asphalt binder content is covered in detail in Asphalt Institute Manual MS-2, 6th Edition, Mix Design Methods, Chapter 5, Marshall Mix Design Method, Section D-5.15, Selection of Final Mix Design, pages 69 thru 77.

If this evaluation reveals no asphalt binder content which meets all project specifications or such a narrow range of asphalt binder contents meeting all project specifications as to be unfeasible and/or

uneconomical to produce, the Materials Engineer may reject the proposed job mix design and require a new proposed job mix formula from the contractor.

16. Report

The report shall include the following:

- Project identification, Source/Supplier of mix and name of the general contractor.
- Aggregate quality identification(s), target gradation, blend ratio of individual stockpiles, blended bulk specific and effective specific gravities. Other properties that may be specified in the Contract such as: fineness modulus of the blended fine aggregate; percent fracture; percent flat and elongated; and the plasticity index of the blended fine aggregate.
- Asphalt **Binder** quality identification, specific gravity at 77°F, and the maximum mixing temperature.
- Anti-strip additive brand/type and the minimum percent required.
- Asphalt **Binder** content at the median of the percent voids in total mix specification and the approved optimum asphalt **binder** content.
- The following properties at the optimum asphalt **binder** content: maximum specific gravity, percent voids in total mix, percent voids in mineral aggregate, percent voids filled, stability, flow, unit mass and the dust-asphalt ratio.
- Graphical representation on a 0.45 power graph of the target gradation with the Lower Specification Limit (LSL)-Upper Specification Limit (USL).
- Graphical representation of asphalt **binder** content versus the following properties: unit weight, stability, flow, percent voids in total mix, percent voids in mineral aggregate and voids filled.
- Identification and address of the laboratory that performed the mix design, that laboratories mix design identification number and the signature/title of the professional engineer who reviewed and approved/disapproved the mix design.

Appendix ATM 417

Example Calculations

(See Example Worksheets.)

See Section 8 of the standard for definitions of the variables.

Contractor Proposed JMF for a Type IIA HMA Mix Design

Sieve	Percent Pass.
3/4"	100
1/2"	89
3/8"	76
#4	52
#8	36
#16	24
#30	15
#50	9
#100	7
#200	5.1

Note: Nominal Maximum Size of this material is 3/4 inch.

Table 2

Sieve Size	Job Mix Formula	PreWash Mass
3/4"	100	0
1/2"	89	129
3/8"	76	282
#4	52	564
#8	36	752
#16	24	893
#30	15	999
#50	9	1069
#100	7	1093
#200	5.1	1115
-#200	0	1175

Preparation of Aggregate

Initial total aggregate mass: $E_i = 1175.0$ g

Calculate cumulative aggregate batch mass by:

$$x = \frac{100 - \text{Percent Passing}}{100} \times E_i$$

$$\text{for No. 4} = \frac{100 - 52}{100} \times 1175.0 = 564 \text{ g}$$

$$\text{for No. 8} = \frac{100 - 36}{100} \times 1175.0 = 752 \text{ g}$$

$$\text{for No. 200} = \frac{100 - 5.1}{100} \times 1175.0 = 1115 \text{ g}$$

Repeat for the other required sieve sizes.

1. Aggregate Batching Correction
 - a. Prepare a sample by batching a specimen with cumulative masses corresponding to cumulative aggregate batch masses calculated above, see the Pre Wash Mass column of Table 2

Table 3

Sieve Size	Job Mix Formula	PreWash Mass	Post Wash Mass
3/4"	100	0	0
1/2"	89	129	128.3
3/8"	76	282	270.0
#4	52	564	542.4
#8	36	752	734.7
#16	24	893	874.7
#30	15	999	969.2
#50	9	1069	1048.7
#100	7	1093	1073.8
#200	5.1	1115	1091.7
-#200	0	1175	1094.0

- b. Wash and sieve this prepared sample in accordance with WAQTC FOP for AASHTO T 27/T 11. Record the cumulative mass on the sieves in a Post Wash Column, see Table 3.
- c. Calculate the adjusted cumulative batch mass for each sieve as follows, See Table 4 for other sieves:

$$\text{For No. 4} = \frac{564^2}{542.4} = 586 \text{ g}$$

$$Z_{Ni} = \frac{X^2}{Y}$$

$$\text{For No. 8} = \frac{752^2}{734.7} = 770 \text{ g}$$

Estimate Projected Optimum Asphalt Content

1. Assuming that no experience with the current sources or contractor is available, the projected optimum and minimum asphalt content will be estimated by both the computational formula and dust/asphalt methods. Refer to Section 7 of the standard for additional information.

- a. Computational Formula

$$\begin{aligned} P &= 0.035a + 0.045b + Kc + F \\ &= 0.035(100 - 36) + 0.045(36 - 5) + (0.20 \times 5.1) + 0.7 \\ &= 5.4, \text{ round to } 5.5\% \end{aligned}$$

Test specimens will be prepared and tested at 4.5 to 6.5 percent cement contents.

- b. Dust/Asphalt Ratio

$$P = \left(\frac{p200}{\text{max. } D/A} \right) = 4.7 / 1.2 = 3.9, \text{ round to } 4.0 \text{ percent}$$

Test specimens will be prepared and tested at 4.0 to 6.0 percent cement contents.

Since the two methods give slightly different ranges, specimens should be prepared and tested at 4.0 to 6.5 percent cement contents.

Preparation of Test Specimens

1. Thickness Adjustment

The thickness of the trial specimen is 2.48 inches, thus requiring adjustment of the initial aggregate mass by:

$$E_a = \frac{2.5 \times E_i}{H} = \frac{2.5 \times 1175}{2.48} = 1184.5 \text{ g}$$

2. Adjust the final batch mass for each sieve by:

$$\text{For No. 4} = \frac{1184.5}{1175} \times \frac{564^2}{542.4} = 591 \text{ g}$$

$$Z_{Na} = \frac{E_a}{E_i} \times Z_{Ni}$$

$$\text{For No. 8} = \frac{1184.5}{1175} \times \frac{752^2}{734.7} = 776 \text{ g}$$

Repeat for the other required sieve sizes; see Table 4 for other sieves.

3. Calculate the mass of the asphalt cement for each set of specimens by:

$$\text{for 4.0 percent} = \frac{1184.5 \times 4.0}{100 - 4.0} = 49.4 \text{ g}$$

$$AW = \frac{E_i \text{ (or } E_a) \times P_{bN}}{100 - P_{bN}}$$

$$\text{for 6.5 percent} = \frac{1184.5 \times 6.5}{100 - 6.5} = 82.3 \text{ g}$$

Repeat for the other asphalt contents.

4. Calculate the cumulative masses for a maximum specific gravity (Rice) test specimen by:

$$\text{For No. 4} = \frac{2000}{1175} \times 586.5 = 998 \text{ g}$$

$$R_N = \frac{Q}{E_i} \times Z_{Ni}$$

$$\text{For No. 8} = \frac{2000}{1175} \times 770 = 1310$$

Repeat for the other required sieve sizes; see Table 4 for other sieves.

5. Coarse Aggregate Properties (i.e. Specific Gravity, Fracture, Flat-Elongated, Unit Weight, et al)

For each coarse aggregate sieve size, calculate the cumulative mass for the required test specimen(s) of coarse aggregate for the required test procedures by the following formula:

$$C_N = \frac{Q}{\text{No. 4 } R_N} \times R_N$$

$$\text{For CA Specific Gravity for No. 4} = 3000 \text{ g}$$

$$\text{for } 1/2" = \frac{3000}{998} \times 221 = 664 \text{ g}$$

Repeat for the other required sieve sizes, see Table 4 for other sieves.

For Other CA Property Tests substitute the appropriate Q.

6. Fine Aggregate Properties (such as Specific Gravity, Sand Equivalent, et al)

For each fine aggregate sieve size, calculate the cumulative masses for the required specimens of fine aggregate specific gravity by the following formula:

$$F_N = \left(\frac{Q}{E_i - Z_{4i}} \right) \times (Z_{Ni} - Z_{4i})$$

$$\text{No. 8} = \left(\frac{1000}{1175.0 - 564} \right) \times (752.0 - 564) = 307 \text{ g}$$

For FA Specific Gravity for

$$\text{No. 200} = \left(\frac{1000}{1175.0 - 564} \right) \times (1115 - 564) = 924.1 \text{ g}$$

Repeat for the other required sieve sizes, See Table 4 for other sieves.

Calculations

1. Calculate the maximum specific gravity for each asphalt content as follows:

a. Calculate the effective specific gravity of the aggregate by:

$$G_{se} = \frac{100 - P_b}{\frac{100}{G_{mm}} - \frac{P_b}{G_b}} = \frac{100 - 5.0}{\frac{100}{2.528} - \frac{5.0}{1.009}} = 2.745$$

b. Calculate the maximum specific gravity for each asphalt content by:

$$G_{mm} = \frac{100}{\frac{100 - P_{bN}}{G_{se}} + \frac{P_{bN}}{G_b}} \quad \text{For 4.0\%} = \frac{100}{\frac{100 - 4.0}{2.745} + \frac{4.0}{1.009}} = 2.568$$

Repeat for other asphalt contents.

2. Calculate the percent air voids in total mix (VTM) for each asphalt content by:

$$\text{VTM} = \frac{G_{mm} - G_{mb}}{G_{mm}} \times 100 \quad \text{For 4.0\%} = \frac{2.568 - 2.403}{2.568} \times 100 = 6.4$$

3. Calculate the percent voids in mineral aggregate (VMA) for each asphalt content by:

a. Calculate the blended aggregate bulk specific gravity by:

$$G_{sb} = \frac{100}{\frac{P_1}{G_1} + \frac{P_2}{G_2} + \dots + \frac{P_N}{G_N}} = \frac{100}{\frac{50}{2.727} + \frac{50}{2.653}} = 2.689$$

b. Calculate the percent voids in mineral aggregate for each asphalt content by:

$$\text{VMA} = 100 - \frac{G_{mb} (100 - P_b)}{G_{sb}} \quad \text{For 4.0\%} = 100 - \frac{2.403 (100 - 4.0)}{2.689} = 14.2$$

c. Calculate the percent voids filled (VFA) with asphalt for each asphalt content by:

$$VFA = 100 \times \frac{VMA - VTM}{VMA} \quad \text{For 4.0\%} = 100 \times \frac{14.2 - 6.4}{14.2} = 55$$

4. Calculate the dust/asphalt ration for each asphalt content by:

a. Calculate the asphalt absorption by:

$$P_{ba} = 100 \left(\frac{G_{se} - G_{sb}}{G_{sb} \times G_{se}} \right) G_b \quad \text{For 4.0\%} = 100 \left(\frac{2.745 - 2.689}{2.689 \times 2.745} \right) 1.009 = 0.77$$

b. Calculate the effective asphalt content for each asphalt content by:

$$P_{be} = P_b - \left(\left(\frac{P_{ba}}{100} \right) \times (100 - P_b) \right) \quad \text{For 4.0\%} = 4.0 - \left(\left(\frac{0.77}{100} \right) \times (100 - 4.0) \right) = 3.3$$

c. Calculate the dust/asphalt ratio by:

$$D/A = \frac{p200}{P_{be}} \quad \text{For 4.0\%} = \frac{4.7}{3.3} = 1.4$$

5. Stability:

Correct Stability values for each specimen that differs from the standard 63.5 mm (2.5") thickness by the following:

$$CS = S \times t \quad \text{for Set 1, Specimen 1} = 3145 \times 0.976 = 3070$$

**Table 4
Cumulative Batch Masses for Example**

Sieve Size		Job Mix Formula	Cumulative Mass g					
			Wash Mass	Post Wash	Correction Z _{Ni}	Marshall Z _{Na}	Rice R _N	SG's C _N
metric	inches							
25	1	100	0	0				
19	3/4	100	0	0	0	0	0	0
12.5	1/2	89	129	128.3	129.7	130.8	220.8	663.5
9.5	3/8	76	282	270.0	294.5	272.2	501.3	1506.7
4.75	#4	52	564	542.4	586.5	591.2	998.2	3000.0
2.36	#8	36	752	734.7	769.7	775.9	1310.1	311.4
1.18	#16	24	893	874.7	911.7	919.1	1551.8	552.6
0.6	#30	15	999	969.2	1029.7	1038.0	1752.7	753.1
0.3	#50	9	1069	1048.7	1089.7	1098.5	1854.8	855.1
0.15	#100	7	1093	1073.8	1112.5	1121.5	1893.7	893.9
0.075	#200	5.1	1115	1091.7	1138.8	1148.0	1938.4	938.5
-0.075	-200	0	1175		1175	1184.5	2000	1000

This page intentionally left blank.

ATM 419 Rutting Susceptibility using an Asphalt Pavement Analyzer

1. Scope

This method describes a procedure for determining the rut susceptibility of hot mix asphalt using an Asphalt Pavement Analyzer (APA).

2. Apparatus

- Asphalt Pavement Analyzer (APA) – A thermostatically controlled device designed to test the rutting susceptibility of hot mix asphalt by applying repetitive linear loads to compacted test specimens through pressurized hoses.
 - The APA shall be thermostatically controlled to maintain the test temperature and conditioning chamber at any set point between $30-60 \pm 1^{\circ}\text{C}$ ($85-140 \pm 1^{\circ}\text{F}$).
 - The APA shall be capable of independently applying loads up to 450 N (100 lbf) to the three wheels. The loads shall be calibrated to the desired test load by a suitable device such as an external force transducer or proving ring.
 - The pressure in the test hoses shall be adjustable and capable of maintaining pressure up to 830 kPa (120 psi).
 - The APA shall be capable of testing six cylindrical specimens simultaneously.
 - The APA shall have a programmable master cycle counter that can be preset to the desired number of cycles for a test. The APA shall be capable to automatically stopping the test at the completion of the programmed number of cycles.
- Balance or scale: Capacity sufficient for the principle sample mass, readable to 0.1 percent or 0.1 g of the total sample mass and meeting the requirements of AASHTO M 231.
- Mixing utensils (bowls, spoon, spatula)
- Ovens and hot plates thermostatically controlled to maintain the various required temperatures within $\pm 3^{\circ}\text{C}$ (5°F).
- Compaction device and molds.

3. Test Specimens

Number of test specimens – A sample will consist of six 150 mm diameter \times 75 mm (6 in diameter \times 3 in) cylindrical specimens.

4. Production Mix

Samples of plant-produced mixtures shall be obtained in accordance with WAQTC FOP for AASHTO T 168. Samples shall be reduced to the appropriate test size in accordance with WAQTC FOP for AASHTO R 47 and compacted while the mixture is still hot. Reheating of loose plant mixture should be avoided.

Laboratory Prepared Mixtures

Mixture proportions will be batched in accordance to the desired Job Mix Formula. The required batch sizes are determined in accordance to ATM 417, Preparation of Aggregate and Preparation of Asphalt. The voids in total mix (VTM) target for the compacted specimens shall be $6.0 + 1.0$ percent unless otherwise directed.

The temperature to which the asphalt binder must be heated to achieve a viscosity of 170 ± 20 cSt ($0.170 + 0.020$ Pa·s) or the mix design mixing temperature shall be the mixing temperature.

Prepare the mixture in accordance with ATM 417, Preparation of Mixtures and Mixture conditioning. The temperature to which the asphalt binder must be heated to achieve a viscosity of 290 ± 30 cSt ($0.290 + 0.030$ Pa·s) or the mix design compaction temperature shall be the compaction temperature.

Roadway Core Specimens

Roadway core specimens shall be 150 mm (6 in) outside diameter with all surfaces of the perimeter perpendicular to the surface of the core within 5 mm (3/16 in). Cores shall be trimmed with a wet masonry saw to a height of 75 ± 3 mm ($3 \pm 1/8$ in). Final adjustment of the core to the top of the testing molds shall be done with Plaster of Paris.

5. Compaction of Specimens

Superpave Gyrotory Compaction

Apparatus (see AASHTO T 312).

1. Compaction of the cylindrical specimens with the Superpave Gyrotory Compactor will be performed in such a manner so that the target air void content of 6.0 ± 1.0 percent is obtained at the specified height of 75 ± 3 mm.
2. Remove the mold and base plate from the oven set at the compaction temperature. Place a paper disc in the bottom of the mold assembly.
3. Transfer the mixture to the mold with care to avoid segregation of the mixture.
4. Place the mold and mixture in the Superpave Gyrotory Compactor and begin compaction as described in the compactor's operation manual.
5. When the compaction procedure is completed, remove the mold and compacted specimen from the compactor. Extrude the specimen from the mold with care to avoid distorting the specimen until it is cooled.
6. Compacted specimens should be left at room temperature (about 25°C or 77°F) and allowed to cool overnight.

6. Determining the Voids Total Mix

1. Determine the bulk specific gravity of the test specimens in accordance with WAQTC FOP for AASHTO T 166, Method A.
2. Determine the maximum specific gravity of the test mixture in accordance with WAQTC FOP for AASHTO T 209.
3. Determine the air void contents of the test specimens in accordance with AASHTO T 269.

7. Test Temperature

The test temperature shall be 105°F unless otherwise directed.

8. Initial Measurements

Place the rut depth measurement template over the specimen. Take initial measurements on three locations of each specimen. Record the measurement for each location to the nearest 0.01 mm.

9. Specimen Conditioning

1. Stabilize the testing chamber temperature at 105°F or as directed.
2. Place the test specimens into the testing molds and secure in the APA.
3. Push the sample holding tray in and secure. Close chamber doors.
4. Allow specimens to condition at the test temperature for 90 minutes.
5. Set PRESET COUNTER to 8000 cycles.
6. Start the testing. A complete test will take approximately 3.5 hours. At the end of the test cycle, the APA will stop.
7. Open the chamber doors, unlock and pull out the sample holding tray.
8. Remove specimens from the testing molds and take rut-depth measurements in the same manner as the Initial Measurements.

10. Calculations

The rut depth at each location is determined by subtracting the final measurement from the initial measurement.

Determine the average rut depth for each specimen; use the average of all measurements to calculate the average rut depth.

The APA rut depth for the mixture is the average of six cylindrical specimens unless otherwise directed.

11. Report

The test report shall include the following information:

- The laboratory name and date of test.
- The mixture type and description.
- The average rut depth to the nearest 0.1 mm.

This page intentionally left blank.

ATM 420 Abrasion of Asphalt Mixtures by the Prall Method

1. Scope

These test methods (Method A and Method B) cover procedures for preparing and testing abrasion caused by studs on cylindrical asphalt mixture specimens.).

2. References

Method A originate from the Prall-method, but it is improved by comprehensive research work to meet an adequate design. According to Swedish research work the method correlates with abrasion in the field.

3. Definitions

- Method A measures the abrasion in cm^3 on the top surface of a cylindrical specimen.
- Method B measures the abrasion in cm^3 on the curved side of a cylindrical specimen.

4. Method A

A cylindrical specimen having a diameter of 100 ± 1 mm and a length of 30 ± 1 mm is brought to a temperature of 5 ± 1 °C. Then, the specimen is worn during 15 minutes by 40 steel spheres. The loss of volume in cm^3 is recorded and named abrasion value.

5. Apparatus

1. Abrasion apparatus according to fig. 1. -Stroke, 43 ± 1 mm. -Connection rod, 200 ± 5 mm.
2. Lid to abrasion apparatus, see fig 2. Quality: stainless steel, SS 2333, Bs 304S31, NF Z7CN18-09, DIN 1.4301, or better.
3. Steel clamp to fasten the lid on top of the machine adjustable by means of the screw at the top.
4. Spheres made of stainless steel according to ISO 3290-1975 with a diameter between 11.50 mm and 12.01 mm. The hardness expressed in HRC should be between 62 and 65
Note 1: The diameter of the balls can be checked quickly by passing them over parallel bars 11.50 mm apart.
5. O-ring made of rubber to protect the edges of the specimen, see fig. 1. Dimension: internal diameter 89.4 mm, diameter of cross section 6.3 mm. Rubber quality: NBR.
6. Rubber plate to be glued at the underside of the lid, see fig.2. Dimensions: diameter 90.0 ± 1.0 mm, thickness 2.0 ± 0.2 mm. Rubber quality: Neoprene.
7. O-ring made of rubber for the groove outside of the cylindrical part of the lid, see fig 2. Dimensions of rubber O-ring: internal diameter 90.0 mm, diameter of cross section 3.0 mm. Rubber quality: NBR
8. Water reservoir for cooling water and for adjustment of specimens temperature to 5 ± 1 °C.
9. Balance: inaccuracy less than 0.1 g.
10. Water pump capacity more than 2.0 liter/minute.

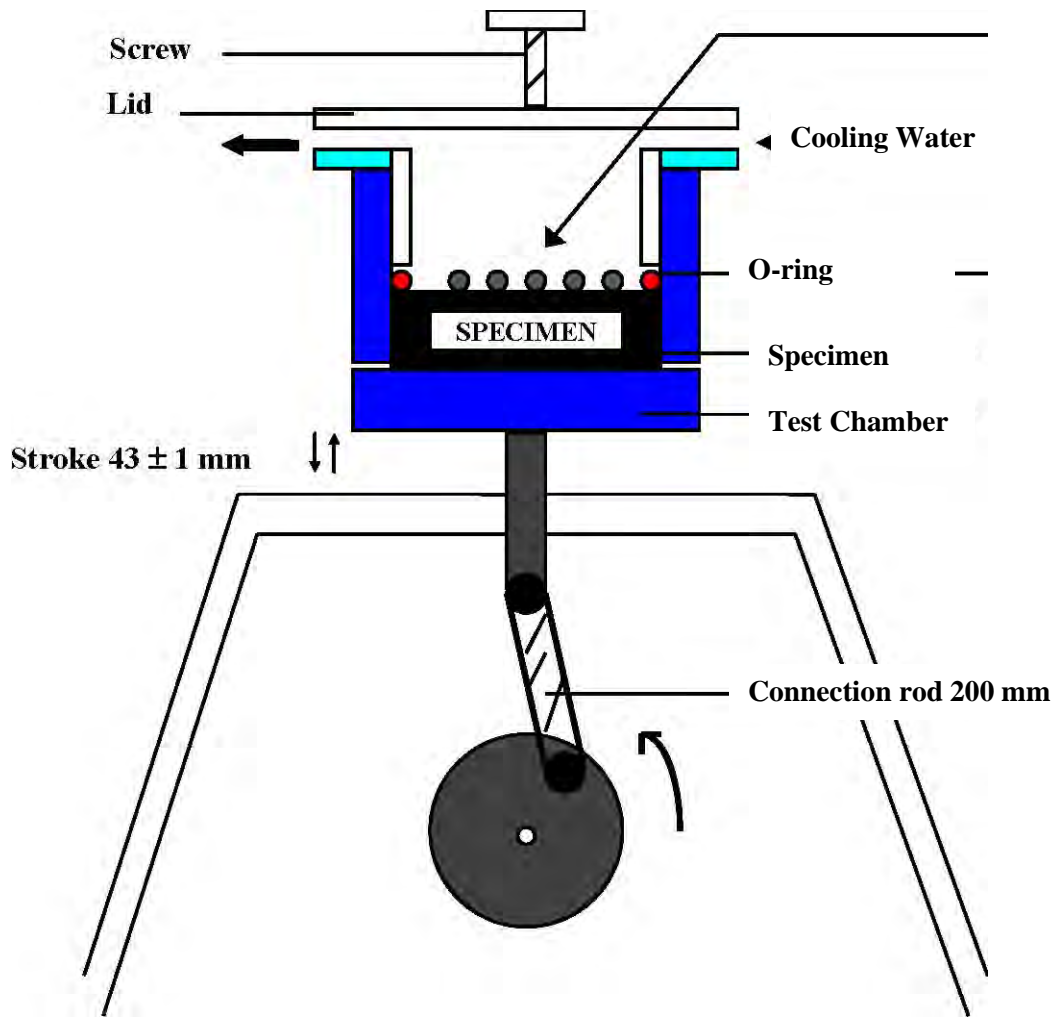

Fig. 1. Abrasion apparatus, in principal

Rubber plate $t=2,0 \pm 0,2$ mm

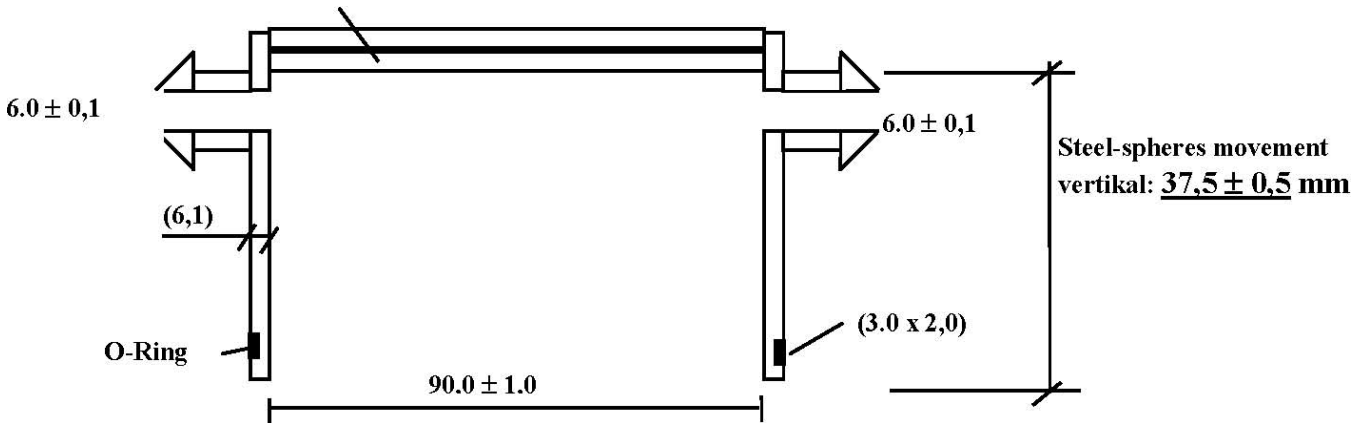

Fig 2. Lid

6. Bituminous Mixtures for Testing

1. Laboratory made specimens and cores from the field.
2. Make at least 4 specimens of diameter 100 ± 1 mm. Cut the specimens to a length of 30 ± 1 mm. When cutting, the end surfaces should be even and parallel, as possible by standard cutting machines. When cutting one should avoid damaging the edges of the specimen.
3. Determine the Bulk density according to ATM 410.

7. Conditioning

1. Temper the specimens for 20 ± 6 hours in water of temperature 5 ± 1 °C.
2. Remove the specimen from the water, surface dry by blotting with a damp towel, and determine the weight.

8. Determination of Abrasion

1. Place the specimen in the test chamber with the cut end up-wards. Make sure that the specimen is tight to the chamber-wall otherwise use tape around the specimen for a snug fit.
2. Place the O-ring on the specimen, and the steel spheres in the O-ring.
3. Fasten the lid onto the test chamber.
4. Adjust the amount of cooling water to 2 ± 0.2 liter/minute.
5. Start the abrasion apparatus and let it work for 15 minutes ± 10 seconds at 950 ± 10 revolutions/minute.
6. Dismantle the apparatus. Remove the specimen from the apparatus and flush it in cold water. Surface dry by blotting with a damp towel, and determine the weight.

9. Calculation

Calculate the abrasion value according to the formula below.

$$\text{Abrasion value, Abr} = \frac{W_1 - W_2}{Bd}$$

Where:

- Abr = abrasion value in cm^3 (1 decimal)
- W_1 = weight of water stored specimen surface dry in air before abrasion(0.1g)
- W_2 = weight of water stored specimen surface dry in air after abrasion(0.1g)
- Bd = Bulk density of specimen according to 6.2 (3 decimals)

10. Report

- Report that the test has been carried out according to this method.
- Report individual as well as average values of Bulk density, with 3 decimals accuracy.
- Report individual values of Abrasion, with 1 decimal accuracy.
- Report average abrasion value, with no decimal.
- Determine the Bulk density according to ATM 410.

11. Precision

The values should be accepted if the coefficient of variation of 4 specimens is less than 15%. Otherwise two extra specimens should be tested, and extremes should be expelled according to common statistical practice.

Coefficient of variation in percent:

$$CV \% = \frac{\sigma}{\mu} \times 100$$

Where:

CV = Coefficient of Variation

σ = Standard Deviation

μ = Mean

ATM 421 Sieve Analysis of Crushed Asphalt Base Course/Recycled Asphalt Material/Pavement

1. Scope

Sieve analysis determines the gradation or distribution of particle sizes within a given sample.

2. Apparatus

- Balance or scale: Accurate to 0.1 percent of the mass being determined or readable to 0.1 g, and meeting the requirements of AASHTO M 231
- Sieves: Meeting the requirements of ASTM E 11
- Containers and shovels

3. Procedure

1. Obtain a representative sample of the material, 18 kg (40 lb) minimum
2. Determine and record the total mass of the sample to the nearest 0.1 percent or 0.1 g.
3. Select sieves to furnish information required by the specifications. Nest the sieves in order of decreasing size from top to bottom. Place the nested sieves over a suitable container such as a 5 gallon bucket.
4. Place the sample on the top sieve.
5. Manually shake the sample until the material is completely separated
6. Any material retained on a sieve that is not crushed asphalt should be manually placed in the container.
7. Determine the cumulative mass passing each sieve to the nearest 0.1 percent or 0.1 g.

4. Calculations

$$\% \text{ passing} = \frac{\text{Mass passing}}{\text{Total mass}} \times 100$$

5. Report

- Results on forms approved by the Department.
- Cumulative mass retained on each sieve.
- Cumulative percent retained on each sieve.
- Report percentages to the nearest 1 percent.

This page intentionally left blank.

ATM 423 Verification of Uniformity and Application Rate, or Residual Application Rate, of Asphaltic Material Distributors

1. Scope

This test method describes the procedure for estimating uniformity and application rate, or residual application rate, of asphaltic material distributors. Bitumen distribution vehicles or paver mounted systems meeting uniformity and rate specifications in both transverse and longitudinal directions shall be acceptable for use on DOT&PF projects. When asphaltic emulsions are applied, the asphaltic residual of the test pads shall be determined by oven drying. When asphaltic materials without water or solvents are applied, the pads do not require oven drying. References: ASTM D2995 “Standard Practice for Estimating Application Rate and Residual Application of Bituminous Distributors”, AASHTO PP 93 “Standard Practice for Asphalt Tack Coat Design”.

This standard involves hazardous materials, operations and equipment. This standard does not purport to address all of the safety problems associated with its use. It is the responsibility of the agency to establish appropriate safety and health practices and to train the user of this standard prior to use. It is the responsibility of the user to consult the appropriate agency authority for and to practice and maintain the appropriate safety and health practices.

2. Apparatus

- 12" x 12" square Geotextile Pads from minimum 8 oz./yd² non-woven fabric
- 40# butcher paper
- Measuring device capable of measuring sample dimensions to the nearest 1/4 inch (6 mm)
- Convection oven capable of maintaining a temperature of 230 ± 9^oF (110 ± 5^oC)
- Balance or scale with capacity sufficient for the principle sample mass, accurate to 0.1 percent of sample mass or readable to 0.1 g, and meeting the requirements of AASHTO M 231

3. Test Specimens

1. Cut a minimum of 42 square Geotextile Pads 12" x 12" from minimum 8 oz. / yd² non-woven fabric. Twelve pads will be deployed side by side to check transverse uniformity across a typical 12' wide lane and 30 pads will be deployed in three groups of 10 each (with groups spaced 100' apart) to check longitudinal uniformity. The 10 pads in each longitudinal group shall be placed end-to-end. Measure and cut geotechnical pad squares to 12 ± 1/4" precision.
2. Number and staple a small (2" x 3.5") index card to each pad with the number facing the pad in manner that will allow reading of the number by lifting one end of the card. Number the transverse pads 1-12 and the longitudinal pads 1-10, 11-20, and 21-30.
3. Cut a minimum of 42 rectangles of 40# butcher paper 30" x 15" and fold in half to make a 15" x 15" folder for each geotextile pad.
4. Place one 12" x 12" square geotextile pad in each 15" x 15" butcher paper folder. Write the pad number on the folder.
5. Determine initial mass (m_i) of each folder/geotextile pad assembly to nearest 0.1 g and record initial mass on folder of each assembly and on the worksheet for this test method. ATM worksheets may be found in the ATMM Appendix.

4. Sample Placement, Collection and Drying

1. Select a representative width and length of the surface to be tack coated for sampling.
2. Create small (approximately two fingers in diameter) loops of duct tape with the adhesive side out. Place two loops of duct tape on one edge of each pad.
3. Place pad assembly with tape facing down on roadway so taped edge is facing the distributor. Apply pressure to the taped pad to secure it to the roadway. Continue this operation by placing additional pads in each selected measurement area as described in section 3, item 1 and as shown in Figure 1. For the transverse row of 12 evenly spaced pads place two layers of butcher paper over the pads in the wheel paths of the distributor. (Typically the distributor truck wheels will have enough tack adhered to them to pick up a layer of butcher paper as they pass over the transverse row of pads. If the distributor truck wheels are tack free, then the two layers of butcher paper over the pads in the wheel path may not be needed.) For the three sets of 10 pads each in the longitudinal direction, place the pads outside the wheel path in the outer one foot (most distant from the centerline) of the lane being tack coated.
4. As soon as the distributor has passed over the geotextile fabric pads, remove each pad from the roadway, remove the tape from the pad, and place each pad in its' respective butcher paper folder.
5. Obtain a sample of the tack material in accordance with ATM 401. Record manufacturer's tank and batch number with sample information. Take sample to lab for % Asphalt determination. Record % Asphalt test result on Application Rate test report forms for ATM 423.
6. Take pads to lab and dry to constant mass at $230 \pm 9^{\circ}\text{F}$ in accordance with ATM 202.
Note: Drying is not required for asphaltic materials that contain no water or evaporable solvents.
7. Record final dry mass (m_f) of each folder/geotextile pad assembly to the nearest 0.1 g on each folder and on the worksheet.

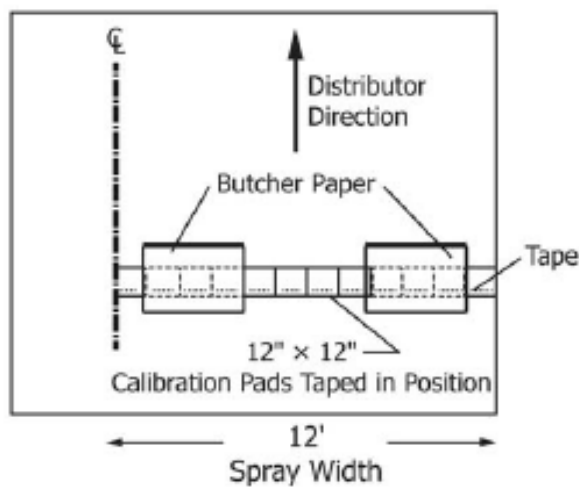

Transverse Pad Layout

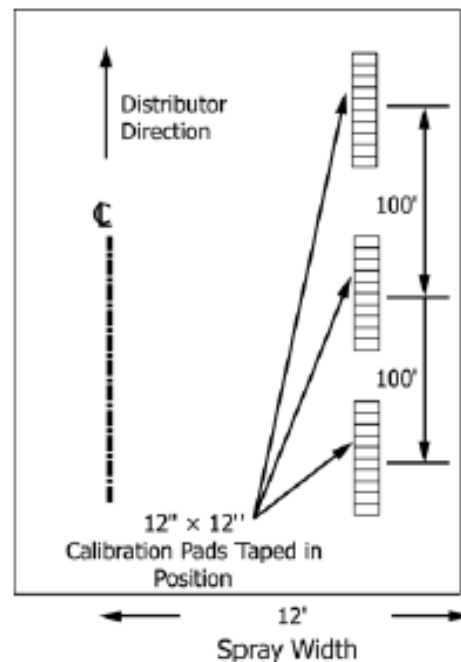

Longitudinal Pad Layout

**Figure 1
Pad Layouts**

5. Calculations

1. Calculate mass of asphaltic material for each pad as follows:

$$B = m_f - m_i$$

Where:

- B = Asphaltic material applied to geotextile pad (g)
- m_f = Final mass of folder/geotextile pad assembly (g)
- m_i = Initial mass of folder/geotextile pad assembly (g)

2. Calculate Application rate of residual asphaltic material in gallons per square yard for each spot test location as follows:

$$A = B/D \times 0.000264 \text{ gal/ml} \times 9 \text{ ft}^2/\text{yd}^2$$

Where:

- A = Application rate of residual asphaltic material in gallons per square yard.
- B = Asphaltic material applied to geotextile pad (g/ft^2), assuming area of each pad is 1.0 ft^2 .
- D = Density of asphaltic material (g/ml) from the asphaltic material supplier.

6. Report

Report on a form approved by the Department the following:

1. State of Alaska Project Name and Number.
2. Lab number, specimen number or identification number, test location and date.
3. Testing technician's name.
4. Tack type, percentage of asphaltic material (when emulsions are used), density, and quantity represented.
5. Type of surface, minimum and maximum application rate for that surface.
6. Distributor meter setting and calculation of theoretical residual application rate (% asphaltic material in tack provided by supplier x distributor meter setting).
7. Application rate on each pad test in transverse and longitudinal groups, maximum deviation in each group, and among the three longitudinal groups, and average application rates in each group and among the three longitudinal groups.
8. Note whether tack application was applied with a bitumen distribution vehicle or a paver mounted system.
9. Passing criteria:
 - a. All pads must exceed minimum specified application rate given for surface type that is tack coated.
 - b. The difference in application rate between the highest and lowest pad in both transverse and longitudinal directions must be less than 20% of the average of the pads in that direction.

Annex A:

Table 1
AASHTO PP 93

Surface Type	Residual Rate Range (gal/yd ²)
New Asphalt	0.020 - 0.045
Existing sphalt	0.040 - 0.070
Milled urfaces	0.040 - 0.080
Concrete PCC)	0.030 - 0.050

Annex B:

ATM 423 Verification of Uniformity and Application Rate, or Residual Application Rate, of Asphaltic Material Distributors (Reference: ASTM D2995)		
Asphalt Worksheet - Tack Coat - Part 1, Transverse		
Project Name:		Sample Number:
Federal No:	AKSAS No.	
Material:	Source:	
Item No:	Location:	
Test Location:	Sampled by:	Date Sampled:
Depth:	Testing Tech:	Date Received:
C_L & Grade Reference:	Quantity Represented:	Lab Number:
Test Specimens		
1. Cut required number of square 12" x 12" Geotextile Pads from minimum 8 oz./yd ² non-woven fabric.		
2. Cut an equal number of minimum 13" x 26" sheets of 50# butcher paper, fold in half to make a square folder.		
3. Place one Geotechnical Pad in each paper sleeve.		
4. Number and weigh each Geotechnical Pad and sleeve and record the mass of each to the nearest 0.1 g on the worksheet.		
Procedure (Transverse Application Rate)		
1. Select enough (12 is typical for a 12' paving width) of the geotextile fabric pads so that when placed transversely end-to-end on the roadway a continuous strip is created across the width of the roadway to be sprayed with asphalt. See Figure 2 in ASTM D2995-14 for position of pad assemblies and butcher paper used for pad protection.		
2. Create a loop of duct tape with adhesive side facing out. Place two loops of duct tape on one edge of each geotextile pad.		
3. Place pad assembly with tape facing down on roadway so taped edge is facing the distributor. Apply pressure to the taped pad to secure it to the roadway. Continue this operation with additional pads for the entire width desired for measurement.		
4. Place two sheets of butcher paper over the pads in the area where the distributor tires will fall on the pads. These sheets should be positioned so they protect the pads from damage by the distributor tires as the truck passes over the pads. The sheets of butcher paper should adhere to the front and rear tires as the distributor passes over the pad assemblies leaving the pad assemblies available to receive the asphalt as it is sprayed onto the roadway surface.		
5. As soon as the distributor has passed over the geotextile fabric pads, remove each pad from the roadway, remove the tape from the pad, and place it in the respective butcher paper sleeve.		
6. Obtain a sample of the asphalt emulsion in accordance with ATM 401. Record manufacturer's tank and batch number and submit it to lab for determination of % Asphalt by AASHTO T59, Section 7. When test is completed, record Tack % Asphalt on both Transverse and Longitudinal tabs within this test calculation form.		
7. Take pads to lab and dry to constant mass in an oven maintained at 230 ± 9°F		
8. Record dry mass of each pad and sleeve assembly to the nearest 0.1 g.		
9. Calculate residual rate of bitumen by subtracting beginning mass of pad and paper from final mass of pad, paper and bitumen.		
10. Record meter setting as truck covers the calibration distance. See Figure 3 in ASTM D2995-14 for position of pad assemblies.		
11. Calculate maximum, minimum, delta of max & min, and average mass of bitumen residue for transverse set of twelve pads.		
12. Passing criteria: 1) All pads exceed A min, 2) $\Delta < 20\%$ of Average.		

Figure 1
Asphalt Worksheet Transverse Example
 1 of 2

Tack Type:	STE-1H	% Asphalt (Mfg):	62%	D, Asphaltic Material Density (g/ml) =	1.0031	
Distributor Type:				Tacked Surface:	Milled	
Tack Residual Application Rate Range:				Distributor Meter Setting =	0.100 gal/sq yd	
Minimum:	0.040 gal/sq yd	Maximum:	0.080 gal/sq yd	Theoretical Residual Application Rate =	0.062 gal/sq yd	
Calculations - Transverse Application Rate				% Asphalt (AASHTO T 59, Sec. 7) =	58%	
Pad Number / Location	Initial pad mass (g)	Initial folder mass (g)	pad, folder Initial mass (g)	pad, folder, asphaltic Final dry mass (g)	B, Asphaltic mass per 1.0 ft ² pad (g/ft ²)	A, Application rate (gallons/yd ²)
1	24.4	23.6	48.0	72.3	24.3	0.058
2	24.9	23.8	48.7	71.8	23.1	0.055
3	24.1	23.1	47.2	73.0	25.8	0.061
4	24.8	23.5	48.3	72.3	24.0	0.057
5	24.5	23.6	48.1	72.9	24.8	0.059
6	24.0	23.2	47.2	72.7	25.5	0.060
7	24.7	23.7	48.4	72.1	23.7	0.056
8	24.2	23.2	47.4	72.4	25.0	0.059
9	24.6	23.9	48.5	72.6	24.1	0.057
10	25.0	23.8	48.8	72.3	23.5	0.056
11	24.3	23.3	47.6	72.2	24.6	0.058
12	24.5	23.4	47.9	72.5	24.6	0.058
					Max =	0.061
					Min =	0.055
					Δ =	0.006
					Average =	0.058
					Transverse distribution meets application rate and uniformity: PASS	
					Average Net Mass of Asphaltic Material (g/ft ²) = 24.4	
					All Samples Average Application Rate (gal/yd ²) = 0.058	

A, Application Rate (gal/yd²) = (B / D) x 0.000264 gal/ml x 9 ft²/yd²

Where: B = Net mass of asphaltic material, g / ft²

D = Density of asphaltic material, g / ml

Existing Surface Type ¹	Residual Asphaltic Material Application Rate Range (gal/yd ²)
New Asphalt Mixture	0.020 - 0.045
Existing Asphalt Mixture	0.040 - 0.070
Milled Surfaces	0.040 - 0.080
Portland Cement Concrete	0.030 - 0.050

Figure 1
Asphalt Worksheet Transverse Example
2 of 2

Asphalt Worksheet - Tack Coat - Part 2, Longitudinal						
Procedure (Longitudinal Application Rate)						
1. Select 30 geotextile fabric pads. Place pads longitudinally in three sections of 10 pads each, placed end to end, with sections spaced 100 feet apart in the long direction down the pavement so the application rate at the specified travel speed may be measured. Position the pads so the distributor tires do not come in contact with the pads. Place the pads far enough in front of the distributor truck to ensure truck has reached the constant speed required for the specified application rate before the beginning of the calibration area. Place pads along one edge of the lane to be tack coated so they receive the most distant foot of tack from the lane centerline.						
Follow steps 2-3, 5, and 7-10 under Procedure (Transverse Application Rate)						
11. Calculate maximum, minimum, delta of max & min, and average mass of bitumen residue for each set of ten pads and for all pads.						
12. Passing criteria: 1) All pads exceed A min, 2) $\Delta < 20\%$ of Average.						
Tack Type:	STE-1H	% Asphalt (Mfg):	62%	D, Asphaltic Material Density (g/ml) =	1.0031	
Distributor Type:				Tacked Surface:	Milled	
Tack Residual Application Rate Range:				Distributor Meter Setting = 0.100 gal/sq yd		
Minimum:	0.040 gal/sq yd	Maximum:	0.080 gal/sq yd	Theoretical Residual Application Rate = 0.062 gal/sq yd		
Calculations - Longitudinal Application Rate				% Asphalt (AASHTO T 59, Sec. 7) = 58%		
Pad Number / Location	Initial pad mass (g)	Initial folder mass (g)	pad, folder Initial mass (g)	pad, folder, asphaltic Final dry mass (g)	B, Asphaltic mass per 1.0 ft ² pad (g/ft ²)	A, Application rate (gallons/yd ²)
1	24.4	23.6	48.0	74.6	26.6	0.063
2	24.9	23.8	48.7	74.1	25.4	0.060
3	24.1	23.1	47.2	75.3	28.1	0.067
4	24.8	23.5	48.3	74.6	26.3	0.062
5	24.5	23.6	48.1	75.2	27.1	0.064
6	24.0	23.2	47.2	75.0	27.8	0.066
7	24.7	23.7	48.4	74.4	26.0	0.062
8	24.2	23.2	47.4	74.7	27.3	0.065
9	24.6	23.9	48.5	74.9	26.4	0.063
10	25.0	23.8	48.8	74.6	25.8	0.061
					Max =	0.067
					Min =	0.060
					Δ =	0.006
					Average =	0.063
					Segment meets application rate and uniformity: PASS	
11	24.1	23.3	47.4	73.3	25.9	0.061
12	24.8	23.4	48.2	72.8	24.6	0.058
13	24.5	23.1	47.6	74.0	26.4	0.063
14	24.0	23.5	47.5	73.3	25.8	0.061
15	24.7	23.6	48.3	73.9	25.6	0.061
16	24.2	23.2	47.4	73.7	26.3	0.062
17	24.6	23.7	48.3	73.1	24.8	0.059
18	25.0	23.2	48.2	73.4	25.2	0.060
19	24.4	23.9	48.3	73.6	25.3	0.060
20	24.9	23.8	48.7	73.3	24.6	0.058
					Max =	0.063
					Min =	0.058
					Δ =	0.004
					Average =	0.060
					Segment meets application rate and uniformity: PASS	

Figure 2
Asphalt Worksheet Longitudinal Example
 1 of 2

21	24.0	23.5	47.5	71.1	23.6	0.056
22	24.7	23.6	48.3	70.6	22.3	0.053
23	24.2	23.2	47.4	71.8	24.4	0.058
24	24.6	23.7	48.3	71.1	22.8	0.054
25	25.0	23.2	48.2	71.7	23.5	0.056
26	24.4	23.9	48.3	71.5	23.2	0.055
27	24.9	23.8	48.7	70.9	22.2	0.053
28	24.1	23.3	47.4	71.2	23.8	0.056
29	24.8	23.4	48.2	71.4	23.2	0.055
30	24.5	23.1	47.6	71.1	23.5	0.056
					Max =	0.058
					Min =	0.053
					Δ =	0.005
					Average =	0.055
					Segment meets application rate and uniformity:	PASS
					All Segments meets application rate and uniformity:	PASS
All Samples Average Net Mass of Asphaltic Material (g/ft ²) =					25.1	
All Samples Average Application Rate (gal/yd ²) =					0.060	

A, Application Rate (gal/yd²) = (B / D) x 0.000264 gal/ml x 9 ft²/yd²

Where: B = Net mass of asphaltic material, g / ft²

D = Density of asphaltic material, g / ml

Existing Surface Type ¹	Residual Asphaltic Material Application Rate Range (gal/yd ²)
New Asphalt Mixture	0.020 - 0.045
Existing Asphalt Mixture	0.040 - 0.070
Milled Surfaces	0.040 - 0.080
Portland Cement Concrete	0.030 - 0.050

Note 1: Adopted from AASHTO PP 93, Table 1

Figure 2
Asphalt Worksheet Longitudinal Example
2 of 2

ATM 424 Spot Test for Estimating Application Rate and Residual Application Rate of Asphaltic Material Distributors

1. Scope

This test method describes the procedure for estimating application rate and residual application rate of asphaltic material distributors. When asphaltic emulsions are applied the asphaltic residual of the test pad shall be determined by oven drying. When asphaltic materials without water or solvents are applied the pad do not require oven drying.

This standard involves hazardous materials, operations and equipment. This standard does not purport to address all of the safety problems associated with its use. It is the responsibility of the agency to establish appropriate safety and health practices and to train the user of this standard prior to use. It is the responsibility of the user to consult the appropriate agency authority for and to practice and maintain the appropriate safety and health practices.

2. Apparatus

- 12" x 12" square Geotextile Pads from minimum 8 oz./yd² non-woven fabric
- 40# butcher paper
- Measuring device capable of measuring sample dimensions to the nearest 1/4 inch (6 mm)
- Convection oven capable of maintaining a temperature of 230 ± 9°F (110 ± 5°C)
- Balance or scale with capacity sufficient for the principle sample mass, accurate to 0.1 percent of sample mass or readable to 0.1 g, and meeting the requirements of AASHTO M 231

3. Test Specimens

1. Cut a minimum of three 12" x 12" square Geotextile Pads from minimum 8 oz./yd² non-woven fabric. Measure squares to 12 ± 1/4" precision.
2. Number and staple a small (2" x 3.5") index card to each pad with the number facing the pad in manner that will allow reading of the number by lifting one end of the card.
3. Cut a minimum of three (or one for each geotextile pad) 30" x 15" rectangles of 40# butcher paper and fold in half to make a 15" x 15" folder for each geotextile pad.
4. Place one 12" x 12" square geotextile pad in each 15" x 15" butcher paper folder. Write the pad number on the folder.
5. Determine initial mass (m_i) of each folder/geotextile pad assembly to nearest 0.1 g and record initial mass on folder of each assembly and on the worksheet for this test method. ATM worksheets may be found in the ATMM Appendix.

4. Sample Placement, Collection and Drying

1. Select a representative area of the surface to be tack coated for sampling. Record station and offset for each spot test location and/or GPS location.
2. Create small (approximately two fingers in diameter) loops of duct tape with the adhesive side out. Place two loops of duct tape on one edge of each pad.

3. Place pad assembly with tape facing down on roadway so taped edge is facing the distributor. Do not place pads in a wheel path of the distributor. Apply pressure to the taped pad to secure it to the roadway. Continue this operation by placing additional pads in each selected measurement area.
4. As soon as the distributor has passed over the geotextile fabric pads, remove each pad from the roadway, remove the tape from the pad, and place it in its' respectively numbered butcher paper folder.
5. Obtain a sample of the tack material in accordance with ATM 401. Record manufacturer's tank and batch number with sample information. Take sample to lab for % Asphalt determination.
6. Take pads to lab and dry to constant mass at $230 \pm 9^{\circ}\text{F}$ in accordance with ATM 202.

Note: Drying is not required for asphaltic materials that contain no water or evaporable solvents.

7. Record final dry mass (m_f) of each folder/geotextile pad assembly to the nearest 0.1 g on each folder and on the worksheet.

5. Calculations

1. Calculate mass of asphaltic material for each pad as follows:

$$B = m_f - m_i$$

Where:

- B = Asphaltic material applied to geotextile pad (g)
- m_f = Final mass of folder/geotextile pad assembly (g)
- m_i = Initial mass of folder/geotextile pad assembly (g)

2. Calculate Application rate of residual asphaltic material in gallons per square yard for each spot test location as follows:

$$A = B/D \times 0.000264 \text{ gal/ml} \times 9 \text{ ft}^2/\text{yd}^2$$

Where:

- A = Application rate of residual asphaltic material in gallons per square yard
- B = Asphaltic material applied to geotextile pad (g/ft^2), assuming area of each pad is 1.0 ft^2
- D = Density of asphaltic material (g/ml) from the asphaltic material supplier

6. Report

Report on a form approved by the Department the following:

1. State of Alaska Project Number.
2. Lab number, specimen number or identification, and test date.
3. Test location and number of spot tests performed.
4. Tack type and quantity represented.
5. Application rate for each spot test and average application rate of all spot tests performed at each location.

Annex A:

ATM 424 Spot Test for Estimating Residual Application Rate of Asphaltic Material Distributors References: ASTM D2995, AASHTO PP 93						
Project Name:				Sample Number:		
Federal No:		AKSAS No.				
Material:		Source:				
Item No:		Location:				
Test Location:		Sampled by:		Date Sampled:		
Depth:		Testing Tech:		Date Received:		
C _L & Grade Reference:		Quantity Represented:		Lab Number:		
Test Specimens						
1. Cut required number of square 12" x 12" ±1/4" geotextile fabric pads from minimum 8 oz./yd ² non-woven fabric.						
2. Cut an equal number of 15" x 30" sheets of 40# butcher paper, fold in half to make a 15" square folder.						
3. Place one geotechnical pad in each paper folder.						
4. Number each folder. Weigh geotechnical pads and folders. Record masses to nearest 0.1 g on folder and worksheet.						
Procedure (Spot Test of Application Rate)						
1. Select enough (3 is typical) of the geotextile pads so that a representative sample may be obtained from the roadway to be sprayed with asphalt. Position the pads in locations where they will not be run over by the wheels of the distributor truck and in locations where the truck will be up to the speed specified by the truck calibration.						
2. Create a loop of duct tape with adhesive side facing out. Place two loops of duct tape on one edge of each geotextile pad.						
3. Place pad with tape facing down on roadway so taped edge is facing the distributor. Apply pressure to the taped pad to secure it to the roadway. Continue this operation by placing additional pads in the desired measurement area.						
4. As soon as the distributor has passed over the geotextile fabric pads, remove each pad from the roadway, remove the tape from the pad, and place it in the respective butcher paper folder.						
5. Obtain a sample of the asphalt emulsion in accordance with ATM 401 and submit it to lab for determination of % Asphalt. Record manufacturer's tank and batch number for tack sample.						
6. Take pad and folder assemblies to lab and dry to constant mass in an oven maintained at 230 ± 9°F						
7. Record dry mass of each pad w/asphaltic material and folder assembly to the nearest 0.1 g.						
8. Calculate application rate of asphaltic material by subtracting beginning mass of pad & folder from final mass of pad, folder & asphalt						
Calculations - Spot Test Application Rate				(All masses in grams)		Density (g/ml) = 1.0031
Pad Number / Location			pad, folder	pad, folder, asphalt	B, asphalt mass per 1.0 ft ² pad	A, Application rate (gallons/yd ²)
	Initial pad mass	Initial folder mass	Initial dry mass	Final dry mass		
1	24.4	23.6	48.0	65.2	17.2	0.041
2	24.9	23.8	48.7	66.3	17.6	0.042
3	24.1	23.1	47.2	64.7	17.5	0.041
4						
5						
6						
7						
8						
9						
10						
11						
12						
Averages =					17.4	0.041
Asphaltic material mass per 1.0 ft ² pad (g): B = m _f - m _i				AASHTO PP 93, Table 1		
Where: m _f = Final dry mass of pad, folder and asphaltic material				Surface Type		
m _i = Initial mass of pad & folder				Residual Rate Range (gal/yd ²)		
Application Rate (gal/yd ²): A = B/D x 0.000264gal/ml x 9 ft ³ /yd ³				New Asphalt		
Where: B = Net mass of asphaltic material, g / 1.0 ft ² pad				Existing Asphalt		
D = Density of asphaltic material, g / ml (use 1.010 if not given)				Milled Surfaces		
				Concrete (PCC)		

Figure 1
Spot Test Worksheet Example

This page left intentionally blank.

ATM 425 Interlayer Bond Strength between Pavement Layers

1. Scope

This test method describes the procedure for determining the interlayer bond strength between two layers of asphalt mixtures or pavement layers by applying a load in the shearing mode.

This standard involves hazardous materials, operations and equipment. This standard does not purport to address all of the safety problems associated with its use. It is the responsibility of the agency to establish appropriate safety and health practices and to train the user of this standard prior to use. It is the responsibility of the user to consult the appropriate agency authority for and to practice and maintain the appropriate safety and health practices.

2. Apparatus

- Wet masonry saw
- Measuring device capable of measuring sample dimensions to the nearest 0.04 in. (1 mm).
- Air chamber or water bath capable of maintaining a temperature of $77\pm 2^{\circ}\text{F}$ ($25\pm 1^{\circ}\text{C}$)
- Loading machine (similar to Marshall Test Apparatus described in ATM 417, AASHTO T 245) capable of producing a minimum uniform vertical displacement of 0.1 in./min. (2.54 mm/min)
- Shear strength tester device (jig) capable of applying confining normal (compressive) load to a specimen. See Appendix A.

3. Test Specimens

1. Test specimens may be either laboratory-compacted asphalt mixtures or sampled from asphalt pavements. Field core samples shall be not less than two inches and not greater than six inches in diameter.
2. Cores shall be taken full depth so that no prying action is needed to extract the cores from the pavement. Care shall be taken to avoid stress or damage to the interface during coring, handling, and transportation. If a core debonds at the interface of interest during the coring operation, acquire an additional core and make note of it on the coring report.
3. Mark the direction of traffic on the roadway surface before coring so that it can be identified on the core.
4. Identify the location of the interface layer with light color marker.

4. Sample Preparation and Conditioning

1. Measure the diameter of the specimen and the thickness of both layers to the nearest 0.04 in. (1 mm).
2. Condition the specimen in the air chamber or water bath at the test temperature of $77\pm 2^{\circ}\text{F}$ ($25\pm 1^{\circ}\text{C}$) for a minimum of 2 hours.
3. Once properly conditioned, place and orient the specimen on the shear tester so that the direction of traffic marked on the core is vertical. Place the top layer on the shearing side.
4. Load the specimen in such manner that the interlayer is located directly in the middle of the gap between the loading and reaction frames. The loading frame is the frame that can move up and down and the reaction frame is the stationary part of the apparatus.
5. Load the specimen by applying the displacement continuously at a rate of 0.1-in (2.54 mm) per minute until failure.

- Record the ultimate load applied (P_{max}) to the specimen to the nearest 1 lb. and the corresponding displacement to the nearest 0.02 in (0.5 mm).

5. Calculations

Calculate the bond shear strength (S_b , psi) as follows:

$$S_b = P_{max} / A$$

Where:

- P_{max} = maximum load applied to the specimen (lb)
- A = cross-sectional area of test specimen (in^2) = $\pi D^2 / 4$
- D = average diameter of test specimen (in)

6. Report

Report on a form approved by the Department the following:

- Specimen number or identification, manufacturing or coring date, and test date.
- Specimen dimensions: core diameter measurements, average diameter, thickness of the existing 'old' layer, and the thickness of the 'new' overlay layer to the nearest 0.04 in (1 mm).
- Failure surface location: identify if failure occurred at the interface, in the existing 'old' layer or in the 'new' overlay layer.
- The maximum load applied to the specimen to the nearest 1 lb.
- The vertical displacement corresponding to the maximum load applied, to nearest 0.02 in (0.5 mm).
- Bond shear strength to the nearest psi.
- If applicable, report average and standard deviation bond strengths for a set of tested specimens or cores.

7. Appendix A

Plan and cross sectional views of the testing apparatus: Refer to Figures 1 and 2 of AASHTO TP 114-18.

Standard Method of Test for Determining the Interlayer Shear Strength (ISS) of Asphalt Pavement Layers

ATM 501 Sampling Freshly Mixed Concrete

Following are guidelines for the use of WAQTC FOP for WAQTC TM 2 by the State of Alaska DOT&PF.

1. Under required Apparatus, Apparatus for wet sieving, add the following clarification:

Mixes with aggregates larger than 1.5 inch apparatus for wet sieving, including: a sieve(s), conforming to AASHTO M 92 (ASTM E11), minimum of 2 ft² (0.19 m²) of sieving area, 1.5 inch screen openings, and conveniently arranged and supported so that the sieve can be shaken rapidly by hand.

Delete and Replace Procedure 3.

- **Sampling from pump or conveyor placement systems**

Obtain sample after a minimum of 1/2 m³ (1/2 yd³) of concrete has been discharged. Obtain samples after all of the pump slurry has been eliminated. Perform sampling by repeatedly passing a receptacle through the entire discharge system or by completely diverting the discharge into a sample container. Do not lower the pump arm from the placement position to ground level for ease of sampling, as it may modify the air content of the concrete being sampled. Do not obtain samples from the very first or last portions of the batch discharge.

With

- **Sampling from pump or conveyor placement systems**

The Department will take all samples from the delivery truck discharge. Obtain sample after a minimum of 1/2 m³ (1/2 yd³) of concrete has been discharged. Do not obtain samples from the very first or last portions of the batch discharge.

This page intentionally left blank.

SAMPLING FRESHLY MIXED CONCRETE WAQTC TM 2

Scope

This **practice** covers procedures for obtaining representative samples of fresh concrete delivered to the project site. The **practice** includes sampling from stationary, paving and truck mixers, and from agitating and non-agitating equipment used to transport central mixed concrete.

This **practice** also covers the removal of large aggregate particles by wet sieving.

Sampling concrete may involve hazardous materials, operations, and equipment. This standard does not purport to address all of the safety problems associated with its use. It is the responsibility of the user of this standard to establish appropriate safety and health practices.

Warning—Fresh Hydraulic cementitious mixtures are caustic and may cause chemical burns to skin and tissue upon prolonged exposure.

Apparatus

- Receptacle: wheelbarrow, bucket or other suitable container that does not alter the properties of the material being sampled
- Sample cover (plastic, canvas, or burlap)
- Shovel
- Cleaning equipment, including scrub brush, rubber gloves, water
- Apparatus for wet sieving, including: a sieve(s), meeting the requirements of FOP for AASHTO T 27/T 11, minimum of 2 ft² (0.19 m²) of sieving area, conveniently arranged and supported so that the sieve can be shaken rapidly by hand.

Procedure

1. Use every precaution in order to obtain samples representative of the true nature and condition of the concrete being placed being careful not to obtain samples from the very first or very last portions of the batch. The size of the sample will be 1.5 times the volume of concrete required for the specified testing, but not less than 0.03 m³ (1 ft³).
2. Dampen the surface of the receptacle just before sampling, empty any excess water.

Note 1: Sampling should normally be performed as the concrete is delivered from the mixer to the conveying vehicle used to transport the concrete to the forms; however, specifications may require other points of sampling, such as at the discharge of a concrete pump.

3. Use one of the following methods to obtain the sample:

- **Sampling from stationary mixers**

Obtain the sample after a minimum of 1/2 m³ (1/2 yd³) of concrete has been discharged. Perform sampling by passing a receptacle completely through the discharge stream, or by completely diverting the discharge into a receptacle. Take care not to restrict the flow of concrete from the mixer, container, or transportation unit so as to cause segregation. These requirements apply to both tilting and **non-tilting mixers**.

- **Sampling from paving mixers**

Obtain the sample after the contents of the paving mixer have been discharged. Obtain **increments** from at least five different locations in the pile and combine into one test sample. Avoid contamination with subgrade material or prolonged contact with absorptive subgrade. To preclude contamination or absorption by the subgrade, the concrete may be sampled by placing a shallow container on the subgrade and discharging the concrete across the container.

- **Sampling from revolving drum truck mixers or agitators**

Obtain the sample after a minimum of $1/2 \text{ m}^3$ ($1/2 \text{ yd}^3$) of concrete has been discharged. Obtain **sample** after all of the water has been added to the mixer. Do not obtain **sample** from the very first or last portions of the batch discharge. Perform sampling by repeatedly passing a receptacle through the entire discharge stream or by completely diverting the discharge into a receptacle. Regulate the rate of discharge of the batch by the rate of revolution of the drum and not by the size of the gate opening.

- **Sampling from open-top truck mixers, agitators, non-agitating equipment, or other types of open-top containers**

Obtain the sample by whichever of the procedures described above is most applicable under the given conditions.

- **Sampling from pump or conveyor placement systems (SEE GUIDANCE PAGE- AK only)**

Obtain sample after a minimum of $1/2 \text{ m}^3$ ($1/2 \text{ yd}^3$) of concrete has been discharged. Obtain **sample** after all of the pump slurry has been eliminated. Perform sampling by repeatedly passing a receptacle through the entire discharge system or by completely diverting the discharge into a receptacle. Do not lower the pump arm from the placement position to ground level for ease of sampling, as it may modify the air content of the concrete being sampled. Do not obtain samples from the very first or last portions of the batch discharge.

4. Transport **sample** to the **testing location**.

5. **Remix with a shovel the minimum amount necessary to ensure uniformity. Protect the sample from direct sunlight, wind, rain, and sources of contamination.**

6. Complete test for temperature and start tests for slump and air content within 5 minutes of obtaining the sample. Start molding specimens for strength tests within 15 minutes of obtaining the sample. Complete the test methods as expeditiously as possible.

Wet Sieving

When required due to oversize aggregate, the concrete sample shall be wet sieved, after transporting but prior to remixing, for slump testing, air content testing or molding test specimens, by the following:

1. Place the sieve designated by the test procedure over the dampened receptacle.
2. Pass the concrete over the designated sieve. Do not overload the sieve (one particle thick).
3. Shake or vibrate the sieve until no more material passes the sieve. A horizontal back and forth motion is preferred.
4. Discard oversize material including all adherent mortar.
5. Repeat until sample of sufficient size is obtained. Mortar adhering to the wet-sieving equipment shall be included with the sample.
6. Using a shovel, remix the sample the minimum amount necessary to ensure uniformity.

Note 2: Wet sieving is not allowed for samples being used for density determinations according to the FOP for AASHTO T 121.

Report

- On forms approved by the agency
- Sample ID
- Date
- Time
- Location
- Quantity represented

This page intentionally left blank.

ATM 502 Temperature of Freshly Mixed Portland Cement Concrete

Following are guidelines for the use of WAQTC FOP for AASHTO T 309 by the State of Alaska DOT&PF.

This page intentionally left blank.

TEMPERATURE OF FRESHLY MIXED PORTLAND CEMENT CONCRETE FOP FOR AASHTO T 309

Scope

This procedure covers the determination of the temperature of freshly mixed Portland Cement Concrete in accordance with AASHTO T 309-22.

Warning—Fresh Hydraulic cementitious mixtures are caustic and may cause chemical burns to skin and tissue upon prolonged exposure.

Apparatus

- **Container:** Made of non-absorptive material and large enough to cover the sensor with concrete at least 75 mm (3 in.) in all directions; concrete cover must also be a least three times the nominal maximum size of the coarse aggregate.
- **Thermometer:** Capable of measuring the temperature of the concrete throughout the temperature range likely to be encountered, at least -18 to 50°C (0 to 120°F), and readable to $\pm 0.5^{\circ}\text{C}$ ($\pm 1^{\circ}\text{F}$) or smaller.

Note 1: Thermometer types suitable for use include ASTM E1 mercury thermometer or ASTM E2251 Low Hazard Precision Liquid-in-glass thermometer; ASTM E2877 digital metal stem thermometer; or thermocouple thermometer ASTM E230, Type T Special or IEC 60584 Type T, Class 1.

Standardization of Thermometer

Each thermometer shall be verified for accuracy annually and whenever there is a question of accuracy. Standardization shall be performed by comparing readings on the thermometer with another calibrated thermometer at two temperatures at least 15°C or 27°F apart.

Sample Locations and Times

The temperature of freshly mixed concrete may be measured in the transporting equipment, in forms, or in sample containers, provided the sensor of the thermometer has at least 75 mm (3 in.) of concrete cover in all direction around it.

Complete the temperature measurement of the freshly mixed concrete within 5 minutes of obtaining the sample.

Procedure

1. Dampen the sample container.
2. Obtain the sample in accordance with the FOP for WAQTC TM 2.
3. Place sensor of the thermometer in the freshly mixed concrete so that it has at least 75 mm (3 in.) of concrete cover in all directions around it.
4. Gently press the concrete in around the sensor of the thermometer at the surface of the concrete so that air cannot reach the sensor.
5. Leave the sensor of the thermometer in the freshly mixed concrete for a minimum of two minutes, or until the temperature reading stabilizes.
6. Complete the temperature measurement of the freshly mixed concrete within 5 minutes of obtaining the sample.
7. Read and record the temperature to the nearest 0.5°C (1°F).

Report

- Results on forms approved by the agency
- Sample ID
- Measured temperature of the freshly mixed concrete to the nearest 0.5°C (1°F)

ATM 503 Slump of Hydraulic Cement Concrete

Following are guidelines for the use of WAQTC FOP for AASHTO T 119 by the State of Alaska DOT&PF.

This page intentionally left blank.

SLUMP OF HYDRAULIC CEMENT CONCRETE FOP FOR AASHTO T 119

Scope

This procedure provides instructions for determining the slump of hydraulic cement concrete in accordance with AASHTO T 119-18. It is not applicable to non-plastic and non-cohesive concrete.

Warning—Fresh Hydraulic cementitious mixtures are caustic and may cause chemical burns to skin and tissue upon prolonged exposure.

Apparatus

- Mold: conforming to AASHTO T 119
 - Metal: a metal frustum of a cone provided with foot pieces and handles. The mold must be constructed without a seam. The interior of the mold shall be relatively smooth and free from projections such as protruding rivets. The mold shall be free from dents. A mold that clamps to a rigid nonabsorbent base plate is acceptable provided the clamping arrangement is such that it can be fully released without movement of the mold.
 - Non-metal: see AASHTO T 119, Section 5.1.2.
- Tamping rod: 16 mm (5/8 in.) diameter and 400 mm (16 in.) to 600 mm (24 in.) long, having a hemispherical tip the same diameter as the rod. (Hemispherical means “half a sphere”; the tip is rounded like half of a ball.)
- Scoop: a receptacle of appropriate size so that each representative increment of the concrete sample can be placed in the container without spillage.
- Tape measure or ruler with at least 5 mm or 1/8 in. graduations
- Base: flat, rigid, non-absorbent moistened surface on which to set the slump mold

Procedure

1. Obtain the sample in accordance with the FOP for WAQTC TM 2. If the concrete mixture contains aggregate retained on the 37.5mm (1½ in.) sieve, the aggregate must be removed in accordance with the Wet Sieving portion of the FOP for WAQTC TM 2.

Begin testing within five minutes of obtaining the sample.

2. Dampen the inside of the mold and place it on a dampened, rigid, nonabsorbent surface that is level and firm.
3. Stand on both foot pieces to hold the mold firmly in place.
4. Use the scoop to fill the mold 1/3 full by volume, to a depth of approximately 67 mm (2 5/8 in.).
5. Consolidate the layer with 25 strokes of the tamping rod, using the rounded end. Distribute the strokes evenly over the entire cross section of the concrete.

For this bottom layer, incline the rod slightly and make approximately half the strokes near the perimeter, and then progress with vertical strokes, spiraling toward the center.

6. Use the scoop to fill the mold 2/3 full by volume, to a depth of approximately 155 mm (6 1/8 in.).
7. Consolidate this layer with 25 strokes of the tamping rod, penetrate approximately 25 mm (1 in.) into the bottom layer. Distribute the strokes evenly.
8. Use the scoop to fill the mold to overflowing.
9. Consolidate this layer with 25 strokes of the tamping rod, penetrate approximately 25 mm (1 in.) into the second layer. Distribute the strokes evenly. If the concrete falls below the top of the mold, stop, add more concrete, and continue rodding for a total of 25 strokes. Keep an excess amount of concrete above the top of the mold at all times. Distribute strokes evenly as before.
10. Strike off the top surface of concrete with a screeding and rolling motion of the tamping rod.
11. Clean overflow concrete away from the base of the mold.
12. Remove the mold from the concrete by raising it carefully in a vertical direction. Raise the mold 300 mm (12 in.) in 5 ± 2 seconds by a steady upward lift with no lateral or torsional (twisting) motion being imparted to the concrete.

Complete the entire operation from the start of the filling through removal of the mold without interruption within an elapsed time of 2 1/2 minutes.

13. Immediately measure the slump:

- a. Invert the slump mold and set it next to the specimen.
- b. Lay the tamping rod across the mold so that it is over the test specimen.
- c. Measure the distance between the bottom of the rod and the displaced original center of the top of the specimen to the nearest 5 mm (1/4 in.).

Note 1: If a decided falling away or shearing off of concrete from one side or portion of the mass occurs, disregard the test and perform a new test on another portion of the sample. If two consecutive tests on a sample of concrete show a falling away or shearing off of a portion of the concrete from the mass of the specimen, the concrete probably lacks the plasticity and cohesiveness necessary for the slump test to be applicable.

14. Discard the tested sample.

Report

- Results on forms approved by the agency
- Sample ID
- Slump to the nearest 5 mm (1/4 in.).

ATM 504 Density (Unit Weight), Yield, and Air Content (Gravimetric) of Concrete

Following are guidelines for the use of WAQTC FOP for AASHTO T 121 by the State of Alaska DOT&PF.

1. Report the volume of the measure to 0.000001 m³ (0.0001 ft³).
2. Calculate aggregate free water mass as follows (use decimal form):

$$\textit{Free Water Mass} = \textit{Total Aggregate Mass} - \textit{Aggregate SSD Mass}$$

$$\textit{Aggregate SSD Mass} = \frac{\textit{Total Aggregate Mass}}{1 + (\textit{Aggregate Moisture Content})} \times (1 + \textit{Percent Absorption})$$

3. Free water percentage = Total moisture content of aggregate – absorbed moisture

This page intentionally left blank.

DENSITY (UNIT WEIGHT), YIELD, AND AIR CONTENT (GRAVIMETRIC) OF CONCRETE FOP FOR AASHTO T 121

Scope

This **method c** covers the determination of density, or unit weight, of freshly mixed concrete in accordance with AASHTO T 121-19. It also provides formulas for calculating the volume of concrete produced from a mixture of known quantities of component materials and provides a method for calculating cement content and cementitious material content – the mass of cement or cementitious material per unit volume of concrete. A procedure for calculating water/cement ratio is also covered.

Warning—Fresh Hydraulic cementitious mixtures are caustic and may cause chemical burns to skin and tissue upon prolonged exposure.

Apparatus

- Measure: May be the bowl portion of the air meter used for determining air content under the FOP for AASHTO T 152. Otherwise, it shall be a **cylindrical metal** container meeting the requirements of AASHTO T 121. The capacity and dimensions of the measure shall conform to those specified in Table 1.
- Balance or scale: Accurate to within 45 g (0.1 lb) or 0.3 percent of the test load, whichever is greater, at any point within the range of use.
- Tamping rod: 16 mm (5/8 in.) diameter and 400 mm (16 in.) to 600 mm (24 in.) long, having a hemispherical tip the same diameter as the rod. (Hemispherical means “half a sphere”; the tip is rounded like half of a ball.)
- Vibrator: frequency at least 9000 vibrations per minute (150 Hz), at least 19 to 38 mm (3/4 to 1 1/2 in.) in diameter but not greater than 38 mm (1 1/2 in.), and the length of the shaft shall be at least 75 mm (3 in.) longer than the depth of the section being vibrated.
- Scoop: a receptacle of appropriate size so that each representative increment of the concrete sample can be placed in the container without spillage.
- Strike-off plate: A flat rectangular metal plate at least 6 mm (1/4 in.) thick or a glass or acrylic plate at least 12 mm (1/2 in.) thick, with a length and width at least 50 mm (2 in.) greater than the diameter of the measure with which it is to be used. The edges of the plate shall be straight and smooth within tolerance of 1.5 mm (1/16 in.).
- Mallet: With a rubber or rawhide head having a mass of 0.57 ± 0.23 kg (1.25 \pm 0.5 lb) for use with measures of 0.014 m^3 (1/2 ft^3) or less or having a mass of 1.02 ± 0.23 kg (2.25 \pm 0.5 lb) for use with measures of 0.028 m^3 (1 ft^3).

Table 1
Dimensions of Measures*

Capacity m ³ (ft ³)	Inside Diameter mm (in.)	Inside Height mm (in.)	Minimum Thicknesses mm (in.)		Nominal Maximum Size of Coarse Aggregate*** mm (in.)
			Bottom	Wall	
0.0071 (1/4)**	203 ±2.54 (8.0 ±0.1)	213 ±2.54 (8.4 ±0.1)	5.1 (0.20)	3.0 (0.12)	25 (1)
0.0142 (1/2)	254 ±2.54 (10.0 ±0.1)	279 ±2.54 (11.0 ±0.1)	5.1 (0.20)	3.0 (0.12)	50 (2)
0.0283 (1)	356 ±2.54 (14.0 ±0.1)	284 ±2.54 (11.2 ±0.1)	5.1 (0.20)	3.0 (0.12)	76 (3)

* **Note 1:** The indicated size of measure shall be for aggregates of nominal maximum size equal to or smaller than that listed.

** Measure may be the base of the air meter used in the FOP for AASHTO T 152.

*** Nominal maximum size: One sieve larger than the first sieve to retain more than 10 percent of the material using an agency specified set of sieves based on cumulative percent retained. Where large gaps in specification sieves exist, intermediate sieve(s) may be inserted to determine nominal maximum size.

Procedure Selection

There are two methods of consolidating the concrete – rodding and vibration. If the slump is greater than 75 mm (3 in.), consolidation is by rodding. When the slump is 25 to 75 mm (1 to 3 in.), internal vibration or rodding can be used to consolidate the sample, but the method used must be that required by the agency in order to obtain consistent, comparable results. For concrete with slump less than 25 mm (1 in.), consolidate the sample by internal vibration. Do not consolidate self-consolidating concrete (SCC).

When using measures greater than 0.0142 m³ (1/2 ft³) see AASHTO T 121.

Procedure

Sampling

Obtain the sample in accordance with the FOP for WAQTC TM 2. Testing may be performed in conjunction with the FOP for AASHTO T 152. When doing so, this FOP should be performed before the FOP for AASHTO T 152.

Note 2: If the two tests are being performed using the same sample, this test shall begin within five minutes of obtaining the sample.

Rodding

1. Determine and record the mass of the empty measure.
2. Dampen the inside of the measure and empty excess water.
3. Use the scoop to fill the measure approximately 1/3 full with concrete. Evenly distribute the concrete in a circular motion around the inner perimeter of the measure.
4. Consolidate the layer with 25 strokes of the tamping rod, using the rounded end. Distribute the strokes evenly over the entire cross section of the concrete. Rod throughout its depth without hitting the bottom too hard.
5. Tap around the perimeter of the measure smartly 10 to 15 times with the mallet to close voids and release trapped air.

6. Add the second layer, filling the measure about 2/3 full. Evenly distribute the concrete in a circular motion around the inner perimeter of the measure.
7. Consolidate this layer with 25 strokes of the tamping rod, penetrating about 25 mm (1 in.) into the bottom layer.
8. Tap around the perimeter of the measure smartly 10 to 15 times with the mallet.
9. Add the final layer, slightly overfilling the measure. Evenly distribute the concrete in a circular motion around the inner perimeter of the measure.
10. Consolidate this layer with 25 strokes of the tamping rod, penetrating about 25 mm (1 in.) into the second layer.
11. Tap around the perimeter of the measure smartly 10 to 15 times with the mallet.
12. After consolidation, the measure should be slightly over full, about 3 mm (1/8 in.) above the rim. If there is a great excess of concrete, remove a portion with the scoop. If the measure is under full, add a small quantity. This adjustment may be done only after consolidating the final layer and before striking off the surface of the concrete.
13. Continue with 'Strike-off and Determining Mass.'

Internal Vibration

1. Determine and record the mass of the empty measure.
2. Dampen the inside of the measure and empty excess water.
3. Use the scoop to fill the measure approximately 1/2 full with concrete. Evenly distribute the concrete in a circular motion around the inner perimeter of the measure.
4. Insert the vibrator at three different points in each layer. Do not let the vibrator touch the bottom or side of the measure. Continue vibration only long enough to achieve proper consolidation of the concrete. Over vibration may cause segregation and loss of appreciable quantities of intentionally entrained air.
5. Tap around the perimeter of the measure smartly 10 to 15 times with the mallet.
6. Slightly overfill the measure. Evenly distribute the concrete in a circular motion around the inner perimeter of the measure.
7. Insert the vibrator at three different points, penetrating the first layer approximately 25 mm (1 in.). Do not let the vibrator touch the side of the measure.
8. Tap around the perimeter of the measure smartly 10 to 15 times with the mallet.
9. After consolidation, the measure should be slightly over full, about 3 mm (1/8 in.) above the rim. If there is a great excess of concrete, remove a portion with the scoop. If the measure is under full, add a small quantity. This adjustment may be done only after consolidating the final layer and before striking off the surface of the concrete.
10. Continue with 'Strike-off and Determining Mass.'

Self-Consolidating Concrete

1. Determine and record the mass of the empty measure.
2. Dampen the inside of the measure and empty excess water.

- Use the scoop to slightly overfill the measure. Evenly distribute the concrete in a circular motion around the inner perimeter of the measure.
- Continue with 'Strike-off and Determining Mass.'

Strike-off and Determining Mass

- Press the strike-off plate flat against the top surface, covering approximately 2/3 of the measure.
- Withdraw the strike-off plate with a sawing motion to finish the 2/3 originally covered.
- Cover the original 2/3 again with the plate; finishing the remaining 1/3 with a sawing motion (do not lift the plate; continue the sawing motion until the plate has cleared the surface of the measure).
- Final finishing may be accomplished with several strokes with the inclined edge of the strike-off plate. The surface should be smooth and free of voids.
- Clean off all excess concrete from the exterior of the measure including the rim.
- Determine and record the mass of the measure and the concrete.
- If the air content of the concrete is to be determined, ensure the rim (flange) is clean and proceed to 'Strike-off and Air Content' Step 3 of the FOP for AASHTO T 152.

Calculations

Mass of concrete in the measure

$$\text{concrete mass} = M_c - M_m$$

Where:

Concrete mass = mass of concrete in measure
 M_c = mass of measure and concrete
 M_m = mass of measure

Density

$$\rho = \frac{\text{concrete mass}}{V_m}$$

Where:

ρ = density of the concrete mix
 V_m = volume of measure (Annex A)

Yield m^3

$$Y_{m^3} = \frac{W}{\rho}$$

Where:

Y_{m^3} = yield (m^3 of the batch of concrete)
 W = total mass of the batch of concrete

Yield yd³

$$Y_{ft^3} = \frac{W}{\rho}$$

$$Y_{yd^3} = \frac{Y_{ft^3}}{27ft^3/yd^3}$$

Where:

Y_{ft^3} = yield (ft³ of the batch of concrete)

Y_{yd^3} = yield (yd³ of the batch of concrete)

W = total mass of the batch of concrete

ρ = density of the concrete mix

Note 5: The total mass, W, includes the masses of the cement, water, and aggregates in the concrete.

Cement Content

$$N = \frac{N_t}{Y}$$

Where:

N = actual cementitious material content per Y_m^3 or Y_{yd}^3

N_t = mass of cementitious material in the batch

Y = Y_m^3 or Y_{yd}^3

Note 6: Specifications may require Portland Cement content and supplementary cementitious materials content.

Water Content

The mass of water in a batch of concrete is the sum of:

- water added at batch plant
- water added in transit
- water added at jobsite
- free water on coarse aggregate*
- free water on fine aggregate*
- liquid admixtures (if required by the agency)

*Mass of free water on aggregate

This information is obtained from concrete batch tickets collected from the driver. Use the Table 2 to convert liquid measures.

Table 2
Liquid Conversion Factors

To Convert From	To	Multiply By
Liters, L	Kilograms, kg	1.0
Gallons, gal	Kilograms, kg	3.785
Gallons, gal	Pounds, lb	8.34
Milliliters, mL	Kilograms, kg	0.001
Ounces, oz	Milliliters, mL	28.4
Ounces, oz	Kilograms, kg	0.0284
Ounces, oz	Pounds, lb	0.0625
Pounds, lb	Kilograms, kg	0.4536

Mass of free water on aggregate (See Guidance Page)

$$\text{Free Water Mass} = \text{CA or FC Aggregate} - \frac{\text{CA or FC Aggregate}}{1 + (\text{Free Water Percentage}/100)}$$

Where:

- Free Water Mass = on coarse or fine aggregate
- FC or CA Aggregate = mass of coarse or fine aggregate
- Free Water Percentage = percent of moisture of coarse or fine aggregate

Water/Cement Ratio

$$\frac{\text{Water Content}}{C}$$

Where:

- Water Content = total mass of water in the batch
- C = total mass of cementitious materials

Example

Mass of concrete in measure (M_m) 16.290 kg (36.06 lb)

Volume of measure (V_m) 0.007079 m³ (0.2494 ft³)

From batch ticket:

Yards batched	4 yd ³
Cement	950 kg (2094 lb)
Fly ash	180 kg (397 lb)
Coarse aggregate	3313 kg (7305 lb)
Fine aggregate	2339 kg (5156 lb)
Water added at plant	295 L (78 gal)

Other

Water added in transit	0
Water added at jobsite	38 L (10 gal)
Total mass of the batch of concrete (W)	7115 kg (15,686 lb)
Moisture content of coarse aggregate	1.7%
Moisture content of coarse aggregate	5.9%

Density

$$\rho = \frac{\text{concrete mass}}{V_m}$$

$$\rho = \frac{16.920 \text{ kg}}{0.007079 \text{ m}^3} = 2390 \text{ kg/m}^3 \quad \rho = \frac{36.06 \text{ lb}}{0.2494 \text{ ft}^3} = 144.6 \text{ lb/ft}^3$$

Given:

concrete mass = 16.920 kg (36.06 lb)

$$V_m = 0.007079 \text{ m}^3 (0.2494 \text{ ft}^3) \text{ (Annex A)}$$

Yield m^3

$$Y_{\text{m}^3} = \frac{W}{\rho}$$

$$Y_{\text{m}^3} = \frac{7115 \text{ kg}}{2390 \text{ kg/m}^3} = 2.98 \text{ m}^3$$

Given:

Total mass of the batch of concrete (W), kg = 7115 kg

Yield yd^3

$$Y_{\text{ft}^3} = \frac{W}{\rho}$$

$$Y_{\text{yd}^3} = \frac{Y_{\text{ft}^3}}{27 \text{ ft}^3/\text{yd}^3}$$

$$Y_{\text{ft}^3} = \frac{15,686 \text{ lb}}{144.6 \text{ lb/ft}^3} = 108.48 \text{ ft}^3 \quad Y_{\text{yd}^3} = \frac{108.48 \text{ ft}^3}{27 \text{ ft}^3/\text{yd}^3} = 4.02 \text{ yd}^3$$

Given:

Total mass of the batch of concrete (W), lb = 15,686 lb

Cement Content

$$N = \frac{N_t}{Y}$$

$$N = \frac{950 \text{ kg} + 180 \text{ kg}}{2.98 \text{ m}^3} = 379 \text{ kg/m}^3 \quad N = \frac{2094 \text{ lb} + 397 \text{ lb}}{4.02 \text{ yd}^3} = 620 \text{ lb/yd}^3$$

Given:

N_t (cement) = 950 kg (2094 lb)

N_t (flyash) = 180 kg (397 lb)

$Y = Y_{\text{m}^3}$ or Y_{yd^3}

Note 6: Specifications may require Portland Cement content and supplementary cementitious materials content.

Free water

$$\text{Free Water Mass} = \text{CA or FC Aggregate} - \frac{\text{CA or FC Aggregate}}{1 + (\text{Free Water Percentage}/100)}$$

$$\text{CA Free Water} = 3313 \text{ kg} - \frac{3313 \text{ kg}}{1 + (1.7/100)} = 55 \text{ kg}$$

$$\text{CA Free Water} = 7305 \text{ lb} - \frac{7305 \text{ lb}}{1 + (1.7/100)} = 122 \text{ lb}$$

$$\text{FA Free Water} = 2339 \text{ kg} - \frac{2339 \text{ kg}}{1 + (5.9/100)} = 130 \text{ kg}$$

$$\text{FA Free Water} = 5156 \text{ lb} - \frac{5156 \text{ lb}}{1 + (5.9/100)} = 287 \text{ lb}$$

Given:

CA aggregate = 3313 kg (7305 lb)
FC aggregate = 2339 kg (5156 lb)
CA moisture content = 1.7%
FC moisture content = 5.9%

Water Content

Total of all water in the mix.

$$\text{Water Content} = [(78 \text{ gal} + 10 \text{ gal}) * 3.785 \text{ kg/gal}] + 55 \text{ kg} + 130 \text{ kg} = 518 \text{ kg}$$

$$\text{Water Content} = [(78 \text{ gal} + 10 \text{ gal}) * 8.34 \text{ lb/gal}] + 122 \text{ lb} + 287 \text{ lb} = 1143 \text{ lb}$$

Given:

Water added at plant = 295 L (78 gal)
Water added at the jobsite = 38 L (10 gal)

Water/ Cement Ratio

$$W/C = \frac{518 \text{ kg}}{950 \text{ kg} + 180 \text{ kg}} = 0.458 \quad W/C = \frac{1143 \text{ lb}}{2094 \text{ lb} + 397 \text{ lb}} = 0.459$$

Report 0.46

Report

- Results on forms approved by the agency
- Sample ID
- Density (unit weight) to the nearest 1 kg/m³ (0.1 lb/ft³)
- Yield to the nearest 0.01 m³ (0.01 yd³)
- Cement content to the nearest 1 kg/m³ (1 lb/yd³)
- Cementitious material content to the nearest 1 kg/m³ (1 lb/yd³)
- Water/Cement ratio to the nearest 0.01

ANNEX A – STANDARDIZATION OF MEASURE

(Mandatory Information)

Standardization is a critical step to ensure accurate test results when using this apparatus. Failure to perform the standardization procedures as described herein will produce inaccurate or unreliable test results.

Apparatus

- Listed in the FOP for AASHTO T 121
 - Measure
 - Balance or scale
 - Strike-off plate
- Thermometer: Standardized liquid-in-glass, or electronic digital total immersion type, accurate to 0.5°C (1°F)

Procedure

1. Determine the mass of the dry measure and strike-off plate.
2. Fill the measure with water at a temperature between 16°C and 29°C (60°F and 85°F) and cover with the strike-off plate in such a way as to eliminate bubbles and excess water.
3. Wipe the outside of the measure and cover plate dry, being careful not to lose any water from the measure.
4. Determine the mass of the measure, strike-off plate, and water in the measure.
5. Determine the mass of the water in the measure by subtracting the mass in Step 1 from the mass in Step 4.
6. Measure the temperature of the water and determine its density from Table A1, interpolating as necessary.
7. Calculate the volume of the measure, V_m , by dividing the mass of the water in the measure by the density of the water at the measured temperature.

Calculations

$$V_m = \frac{M}{\rho_w}$$

Where:

V_m = volume of the mold

M = mass of water in the mold

ρ_w = density of water at the measured temperature

Example

Mass of water in Measure = 7.062 kg (15.53 lb)

Density of water at 23°C (73.4°F) (ρ_w) = 997.54 kg/m³ (62.274 lb/ft³)

$$V_m = \frac{7.062 \text{ kg}}{997.54 \text{ kg/m}^3} = 0.007079 \text{ m}^3 \quad V_m = \frac{15.53 \text{ lb}}{62.274 \text{ lb/ft}^3} = 0.2494 \text{ ft}^3$$

Table A1
Unit Mass of Water
15°C to 30°C

°C	(°F)	kg/m ³	(lb/ft ³)	°C	(°F)	kg/m ³	(lb/ft ³)
15	(59.0)	999.10	(62.372)	23	(73.4)	997.54	(62.274)
15.6	(60.0)	999.01	(62.366)	23.9	(75.0)	997.32	(62.261)
16	(60.8)	998.94	(62.361)	24	(75.2)	997.29	(62.259)
17	(62.6)	998.77	(62.350)	25	(77.0)	997.03	(62.243)
18	(64.4)	998.60	(62.340)	26	(78.8)	996.77	(62.227)
18.3	(65.0)	998.54	(62.336)	26.7	(80.0)	996.59	(62.216)
19	(66.2)	998.40	(62.328)	27	(80.6)	996.50	(62.209)
20	(68.0)	998.20	(62.315)	28	(82.4)	996.23	(62.192)
21	(69.8)	997.99	(62.302)	29	(84.2)	995.95	(62.175)
21.1	(70.0)	997.97	(62.301)	29.4	(85.0)	995.83	(62.166)
22	(71.6)	997.77	(62.288)	30	(86.0)	995.65	(62.156)

Report

- Measure ID
- Date Standardized
- Temperature of the water
- Volume, V_m, of the measure

ATM 505 Air Content of Freshly Mixed Concrete by the Pressure Method

Following are guidelines for the use of WAQTC FOP for AASHTO T 152 by the State of Alaska DOT&PF.

- An alternate calibration procedure may be used as found in Standard Practice 8.
- Correction Factors should be checked for each new aggregate source and for sources that have a history of a correction factor in excess of 0.4 percent.
- If the slump is 1 in or less, consolidate by vibrator. If the slump is above 1 in, consolidate by rodding. Concrete for curb and gutter shall be rodded regardless of slump.

This page intentionally left blank.

AIR CONTENT OF FRESHLY MIXED CONCRETE BY THE PRESSURE METHOD FOP FOR AASHTO T 152

Scope

This procedure covers determination of the air content in freshly mixed Portland Cement Concrete containing dense aggregates in accordance with AASHTO T 152-19, Type B meter. It is not for use with lightweight or highly porous aggregates. This procedure includes standardization of the Type B air meter gauge, Annex A.

Warning—Fresh Hydraulic cementitious mixtures are caustic and may cause chemical burns to skin and tissue upon prolonged exposure.

Apparatus

- Air meter: Type B, as described in AASHTO T 152

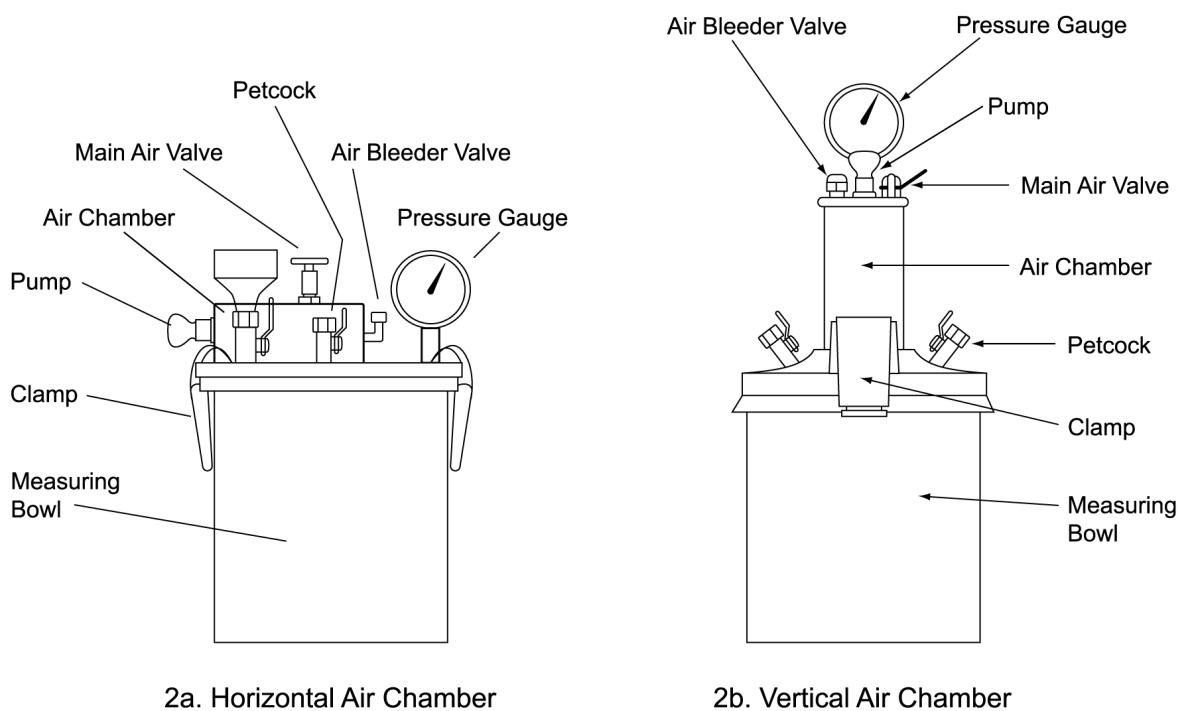

Type B Meter

- Balance or scale: Accurate to 0.3 percent of the test load at any point within the range of use (for Method 1 standardization only)
- Tamping rod: 16 mm (5/8 in.) diameter and 400 mm (16 in.) to 600 mm (24 in.) long, having a hemispherical tip the same diameter as the rod. (Hemispherical means “half a sphere”; the tip is rounded like half of a ball.)
- Vibrator: frequency at least 9000 vibrations per minute (150 Hz), at least 19 to 38 mm (3/4 to 1 1/2 in.) in diameter but not greater than 38 mm (1 1/2 in.), and the length of the shaft shall be at least 75 mm (3 in.) than the depth of the section being vibrated.
- Scoop: a receptacle of appropriate size so that each representative increment of the concrete sample can be placed in the container without spillage.
- Container for water: rubber syringe (may also be a squeeze bottle)

- Strike-off bar: Approximately 300 mm x 22 mm x 3 mm (12 in. x 3/4 in. x 1/8 in.)
- Strike-off plate: A flat rectangular metal plate at least 6 mm (1/4 in.) thick or a glass or acrylic plate at least 12 mm (1/2 in.) thick, with a length and width at least 50 mm (2 in.) greater than the diameter of the measure with which it is to be used. The edges of the plate shall be straight and smooth within tolerance of 1.5 mm (1/16 in.).

Note 1: Use either the strike-off bar or strike-off plate; both are not required.

- Mallet: With a rubber or rawhide head having a mass of 0.57 ± 0.23 kg (1.25 \pm 0.5 lb)

Procedure Selection

There are two methods of consolidating the concrete – rodding and vibration. If the slump is greater than 75 mm (3 in.), consolidation is by rodding. When the slump is 25 to 75 mm (1 to 3 in.), internal vibration or rodding can be used to consolidate the sample, but the method used must be that required by the agency in order to obtain consistent, comparable results. For concrete with slumps less than 25 mm (1 in.), consolidate the sample by internal vibration. Do not consolidate self-consolidating concrete (SCC).

Procedure

Sampling

Obtain the sample in accordance with the FOP for WAQTC TM 2. If the concrete mixture contains aggregate retained on the 37.5mm (1½ in.) sieve, the aggregate must be removed in accordance with the Wet Sieving portion of the FOP for WAQTC TM 2.

Testing shall begin within five minutes of obtaining the sample.

Rodding

1. Dampen the inside of the air meter measure and place on a firm level surface.
2. Use the scoop to fill the measure approximately 1/3 full with concrete. Evenly distribute the concrete in a circular motion around the inner perimeter of the measure.
3. Consolidate the layer with 25 strokes of the tamping rod, using the rounded end. Distribute the strokes evenly over the entire cross section of the concrete. Rod throughout its depth without hitting the bottom too hard.
4. Tap around the perimeter of the measure smartly 10 to 15 times with the mallet to close voids and release trapped air.
5. Add the second layer, filling the measure about 2/3 full. Evenly distribute the concrete in a circular motion around the inner perimeter of the measure.
6. Consolidate this layer with 25 strokes of the tamping rod, penetrating about 25 mm (1 in.) into the bottom layer.
7. Tap around the perimeter of the measure smartly 10 to 15 times with the mallet.
8. Add the final layer, slightly overfilling the measure. Evenly distribute the concrete in a circular motion around the inner perimeter of the measure.
9. Consolidate this layer with 25 strokes of the tamping rod, penetrating about 25 mm (1 in.) into the second layer.
10. Tap around the perimeter of the measure smartly 10 to 15 times with the mallet.
11. After consolidation, the measure should be slightly over full, about 3 mm (1/8 in.) above the rim. If there is a great excess of concrete, remove a portion with the trowel or scoop. If the measure is under full, add a small

quantity. This adjustment may be done only after consolidating the final layer and before striking off the surface of the concrete.

12. Continue with 'Strike-off and Air Content.'

Internal Vibration

1. Dampen the inside of the air meter measure and place on a firm level surface.
2. Use the scoop to fill the measure approximately 1/2 full with concrete. Evenly distribute the concrete in a circular motion around the inner perimeter of the measure.
3. Insert the vibrator at three different points. Do not let the vibrator touch the bottom or side of the measure. Remove the vibrator slowly, so that no air pockets are left in the material. Continue vibration only long enough to achieve proper consolidation of the concrete. Over vibration may cause segregation and loss of appreciable quantities of intentionally entrained air.
4. Tap around the perimeter of the measure smartly 10 to 15 times with the mallet.
5. Use the scoop to fill the measure a bit over full. Evenly distribute the concrete in a circular motion around the inner perimeter of the measure.
6. Insert the vibrator at three different points, penetrating the first layer approximately 25 mm (1 in.). Do not let the vibrator touch the side of the measure. Remove the vibrator slowly, so that no air pockets are left in the material. Continue vibration only long enough to achieve proper consolidation of the concrete. Over vibration may cause segregation and loss of appreciable quantities of intentionally entrained air.
7. Tap around the perimeter of the measure smartly 10 to 15 times with the mallet.
8. Continue with 'Strike-off and Air Content.'

Self-Consolidating Concrete

1. Dampen the inside of the air meter measure and place on a firm level surface.
2. Use the scoop to slightly overfill the measure. Evenly distribute the concrete in a circular motion around the inner perimeter of the measure.
3. Continue with 'Strike-off and Air Content.'

Strike-Off and Air Content

1. Strike off the surface of the concrete and finish it smoothly with a sawing action of the strike-off bar or plate, using great care to leave the measure just full. The surface should be smooth and free of voids.
2. Clean the top flange of the measure to ensure a proper seal.
3. Moisten the inside of the cover and check to see that both petcocks are open, and the main air valve is closed.
4. Clamp the cover on the measure.
5. Inject water through a petcock on the cover until water emerges from the petcock on the opposite side. Jar the meter gently until all air is expelled from this same petcock.
6. Verify that water is present in both petcocks.
7. Close the air bleeder valve and pump air into the air chamber until the needle goes past the initial pressure determined for the gauge. Allow a few seconds for the compressed air to cool.

8. Tap the gauge gently with one hand while slowly opening the air bleeder valve until the needle rests on the initial pressure. Close the air bleeder valve.
9. Close both petcocks.
10. Open the main air valve.
11. Tap the side of the measure smartly with the mallet.
12. With the main air valve open, lightly tap the gauge to settle the needle, and then read the air content to the nearest 0.1 percent.
13. Release or close the main air valve.
14. Open both petcocks to release pressure, remove the concrete, and thoroughly clean the cover and measure with clean water.
15. Open the main air valve to relieve the pressure in the air chamber.

Report

- On forms approved by the agency
- Sample ID
- Percent of air to the nearest 0.1 percent.
- Some agencies require an aggregate correction factor in order to determine total percent of entrained air.

Total % entrained air = Gauge reading – aggregate correction factor from mix design

(See AASHTO T 152 for more information.)

ANNEX A

STANDARDIZATION OF AIR METER GAUGE

(Mandatory Information)

Standardization is a critical step to ensure accurate test results when using this apparatus. Failure to perform the standardization procedures as described below will produce inaccurate or unreliable test results.

Standardization shall be performed at a minimum of once every three months. Record the date of the standardization, the standardization results, and the name of the technician performing the standardization in the logbook kept with each air meter.

There are two methods for standardizing the air meter, mass or volume, both are covered below.

1. Screw the short piece of straight tubing into the threaded petcock hole on the underside of the cover.
2. Determine and record the mass of the dry, empty air meter measure and cover assembly (mass method only).
3. Fill the measure nearly full with water.
4. Clamp the cover on the measure with the tube extending down into the water. Mark the petcock with the tube attached for future reference.
5. Add water through the petcock having the pipe extension below until all air is forced out the other petcock.
6. Wipe off the air meter measure and cover assembly; determine and record the mass of the filled unit (mass method only).
7. Pump up the air pressure to a little beyond the predetermined initial pressure indicated on the gauge. Wait a few seconds for the compressed air to cool, and then stabilize the gauge hand at the proper initial pressure by pumping up or relieving pressure, as needed.
8. Close both petcocks and immediately open the main air valve exhausting air into the measure. Wait a few seconds until the meter needle stabilizes. The gauge should now read 0 percent. If two or more tests show a consistent variation from 0 percent in the result, change the initial pressure line to compensate for the variation, and use the newly established initial pressure line for subsequent tests.
9. Determine which petcock has the straight tube attached to it. Attach the curved tube to external portion of the same petcock.
10. Pump air into the air chamber. Open the petcock with the curved tube attached to it. Open the main air valve for short periods of time until 5 percent of water by mass or volume has been removed from the air meter. Remember to open both petcocks to release the pressure in the measure and drain the water in the curved tube back into the measure. To determine the mass of the water to be removed, subtract the mass found in Step 2 from the mass found in Step 6. Multiply this value by 0.05. This is the mass of the water that must be removed. To remove 5 percent by volume, remove water until the external standardization vessel is level full.
Note A1: Many air meters are supplied with a standardization vessel(s) of known volume that are used for this purpose. Standardization vessel must be protected from crushing or denting. If an external standardization vessel is used, confirm what percentage volume it represents for the air meter being used. Vessels commonly represent 5 percent volume, but they are for specific size meters. This should be confirmed by mass.
11. Remove the curved tube. Pump up the air pressure to a little beyond the predetermined initial pressure indicated on the gauge. Wait a few seconds for the compressed air to cool, and then stabilize the gauge hand at the proper initial pressure by pumping up or relieving pressure, as needed.
12. Close both petcocks and immediately open the main air valve exhausting air into the measure. Wait a few seconds until the meter needle is stabilized. The gauge should now read 5.0 ± 0.1 percent. If the gauge is

outside that range, the meter needs adjustment. The adjustment could involve adjusting the starting point so that the gauge reads 5.0 ± 0.1 percent when this standardization is run or could involve moving the gauge needle to read 5.0 percent. Any adjustment should comply with the manufacturer's recommendations.

13. When the gauge hand reads correctly at 5.0 percent, additional water may be withdrawn in the same manner to check the results at other values such as 10 percent or 15 percent.
14. If an internal standardization vessel is used, follow Steps 1 through 8 to set initial reading.
15. Release pressure from the measure and remove cover. Place the internal standardization vessel into the measure. This will displace 5 percent of the water in the measure. (See AASHTO T 152 for more information on internal standardization vessels.)
16. Place the cover back on the measure and add water through the petcock until all the air has been expelled.
17. Pump up the air pressure chamber to the initial pressure. Wait a few seconds for the compressed air to cool, and then stabilize the gauge hand at the proper initial pressure by pumping up or relieving pressure, as needed.
18. Close both petcocks and immediately open the main air valve exhausting air into the measure. Wait a few seconds until the meter needle stabilizes. The gauge should now read 5 percent.
19. Remove the extension tubing from threaded petcock hole in the underside of the cover before starting the test procedure.

Report

- Air meter ID
- Date standardized
- Initial pressure (IP)

ATM 506 Making and Curing Concrete Test Specimens in the Field

Following are guidelines for the use of WAQTC FOP for AASHTO **R 100** by the State of Alaska DOT&PF.

- Under “Apparatus” add:
 - Shims
 - Bubble Level
- When Concrete test specimens are made in conjunction with other testing, (WAQTC FOP for AASHTO T 121 and WAQTC FOP for AASHTO T 152), the same method of consolidation must be used for all tests.
- When cylinders must be transported, transportation time shall not exceed 8 hours. If this transportation time requirement cannot be met, the transportation time must be approved by the Engineer in writing prior to transporting.
- Acceptance testing may be done with either 150 mm by 300 mm (6 in by 12 in) cylinders or 100 mm by 200 mm (4 in by 8 in) cylinders.
- For “Method 1- Initial cure in a temperature controlled chest-type curing box” between step 1 and step 2 insert:
 - Place the curing box in an area that will not be disturbed by construction activities. Ensure curing box is level, use shims if needed.
- For “Method 2 - Initial cure by burying in earth or by using a curing box over the cylinder” before step 1 add:
 - Choose a curing location that will not be disturbed by construction activities.

This page intentionally left blank.

METHOD OF MAKING AND CURING CONCRETE TEST SPECIMENS IN THE FIELD FOP FOR AASHTO R 100

Scope

This practice covers the method for making, initially curing, and transporting concrete test specimens in the field in accordance with AASHTO R 100-22.

Warning—Fresh Hydraulic cementitious mixtures are caustic and may cause chemical burns to skin and tissue upon prolonged exposure.

Apparatus

- Concrete cylinder molds: Conforming to AASHTO M 205 with a length equal to twice the diameter. Standard specimens shall be 150 mm (6 in.) by 300 mm (12 in.) cylinders. Mold diameter must be at least three times the maximum aggregate size unless wet sieving is conducted according to the FOP for WAQTC TM 2. Agency specifications may allow cylinder molds of 100 mm (4 in.) by 200 mm (8 in.) when the nominal maximum aggregate size does not exceed 25 mm (1 in.).
- Beam molds: Rectangular in shape with ends and sides at right angles to each other. Must be sufficiently rigid to resist warpage. Surfaces must be smooth. Molds shall produce length no more than 1.6 mm (1/16 in.) shorter than that required (greater length is allowed). Maximum variation from nominal cross section shall not exceed 3.2 mm (1/8 in.). Ratio of width to depth may not exceed 1:5; the smaller dimension must be at least 3 times the maximum aggregate size. Standard beam molds shall result in specimens having width and depth of not less than 150 mm (6 in.). Agency specifications may allow beam molds of 100 mm (4 in.) by 100 mm (4 in.) when the nominal maximum aggregate size does not exceed 25 mm (1 in.). Specimens shall be cast and hardened with the long axes horizontal.
- Standard tamping rod: 16 mm (5/8 in.) in diameter and 400 mm (16 in.) to 600 mm (24 in.) long, having a hemispherical tip of the same diameter as the rod for preparing 150 mm (6 in.) x 300 mm (12 in.) cylinders.
- Small tamping rod: 10 mm (3/8 in.) diameter and 305 mm (12 in.) to 600 mm (24 in.) long, having a hemispherical tip of the same diameter as the rod for preparing 100 mm (4 in.) x 200 mm (8 in.) cylinders.
- Vibrator: At least 9000 vibrations per minute, with a diameter no more than ¼ the diameter or width of the mold and at least 75 mm (3 in.) longer than the section being vibrated.
- Scoop: a receptacle of appropriate size so that each representative increment of the concrete sample can be placed in the container without spillage.
- Trowel or float
- Mallet: With a rubber or rawhide head having a mass of 0.57 ± 0.23 kg (1.25 ± 0.5 lb.).
- Rigid base plates and cover plates: may be metal, glass, or plywood.
- Initial curing facilities: Temperature-controlled curing box or enclosure capable of maintaining the required range of 16 to 27°C (60 to 80°F) during the entire initial curing period (for concrete with compressive strength of 40 Mpa (6000 psi) or more, the temperature shall be 20 to 26°C (68 to 78°F). As an alternative, sand or earth for initial cylinder protection may be used provided that the required temperature range is maintained, and the specimens are not damaged.

- **Thermometer:** Capable of registering both maximum and minimum temperatures during the initial cure meeting the requirements for FOP for AASHTO T 309.

Procedure – Making Specimens – General

1. Obtain the sample according to the FOP for WAQTC TM 2.
2. Wet Sieving per the FOP for WAQTC TM 2 is required for 150 mm (6 in.) diameter specimens containing aggregate with a nominal maximum size greater than 50 mm (2 in.); screen the sample over the 50 mm (2 in.) sieve.
3. Remix the sample after transporting to testing location.
4. Begin making specimens within 15 minutes of obtaining the sample.
5. Set molds upright on a level, rigid base in a location free from vibration and relatively close to where they will be stored.
6. Fill molds in the required number of layers, attempting to slightly overfill the mold on the final layer. Add or remove concrete before completion of consolidation to avoid a deficiency or excess of concrete.
7. There are two methods of consolidating the concrete – rodding and internal vibration. If the slump is greater than 25 mm (1 in.), consolidation may be by rodding or vibration. When the slump is 25 mm (1 in.) or less, consolidate the sample by internal vibration. Agency specifications may dictate when rodding or vibration will be used.

Procedure – Making Cylinders –Self-Consolidating Concrete

1. Use the scoop to slightly overfill the mold. Evenly distribute the concrete in a circular motion around the inner perimeter of the mold.
2. Strike off the surface of the molds with tamping rod, straightedge, float, or trowel.
3. Immediately begin initial curing.

Procedure – Making Cylinders – Rodding

1. For the standard 150 mm (6 in.) by 300 mm (12 in.) specimen, fill each mold in three approximately equal layers, moving the scoop or trowel around the perimeter of the mold to evenly distribute the concrete. For the 100 mm (4 in.) by 200 mm (8 in.) specimen, fill the mold in two layers. When filling the final layer, slightly overfill the mold.
2. Consolidate each layer with 25 strokes of the appropriate tamping rod, using the rounded end. Distribute strokes evenly over the cross section of the concrete. Rod the first layer throughout its depth without forcibly hitting the bottom. For subsequent layers, rod the layer throughout its depth penetrating approximately 25 mm (1 in.) into the underlying layer.
3. After rodding each layer, tap the sides of each mold 10 to 15 times with the mallet (reusable steel molds) or lightly with the open hand (single-use light-gauge molds).
4. Strike off the surface of the molds with tamping rod, straightedge, float, or trowel.
5. Immediately begin initial curing.

Procedure – Making Cylinders – Internal Vibration

1. Fill the mold in two layers.

2. Insert the vibrator at the required number of different points for each layer (two points for 150 mm (6 in.) diameter cylinders; one point for 100 mm (4 in.) diameter cylinders). When vibrating the bottom layer, do not let the vibrator touch the bottom or sides of the mold. When vibrating the top layer, the vibrator shall penetrate into the underlying layer approximately 25 mm (1 in.)
3. Remove the vibrator slowly, so that no large air pockets are left in the material.

Note 1: Continue vibration only long enough to achieve proper consolidation of the concrete. Over vibration may cause segregation and loss of appreciable quantities of intentionally entrained air.

4. After vibrating each layer, tap the sides of each mold 10 to 15 times with the mallet (reusable steel molds) or lightly with the open hand (single-use light-gauge molds).
5. Strike off the surface of the molds with tamping rod, straightedge, float, or trowel.
6. Immediately begin initial curing.

Procedure – Making Flexural Beams – Rodding

1. Fill the mold in two approximately equal layers with the second layer slightly overfilling the mold.
2. Consolidate each layer with the tamping rod once for every 1300 mm² (2 in²) using the rounded end. Rod each layer throughout its depth, taking care to not forcibly strike the bottom of the mold when compacting the first layer. Rod the second layer throughout its depth, penetrating approximately 25 mm (1 in.) into the lower layer.
3. After rodding each layer, strike the mold 10 to 15 times with the mallet and spade along the sides and end using a trowel.
4. Strike off the surface of the molds with tamping rod, straightedge, float, or trowel.
5. Immediately begin initial curing.

Procedure – Making Flexural Beams – Vibration

1. Fill the mold to overflowing in one layer.
2. Consolidate the concrete by inserting the vibrator vertically along the centerline at intervals not exceeding 150 mm (6 in.). Take care to not over-vibrate and withdraw the vibrator slowly to avoid large voids. Do not contact the bottom or sides of the mold with the vibrator.
3. After vibrating, strike the mold 10 to 15 times with the mallet.
4. Strike off the surface of the molds with tamping rod, straightedge, float, or trowel.
5. Immediately begin initial curing.

Procedure – Initial Curing

- When moving cylinder specimens made with single use molds support the bottom of the mold with trowel, hand, or other device.
- For initial curing of cylinders, there are two methods, use of which depends on the agency. In both methods, the curing place must be firm, within ¼ in. of a level surface, and free from vibrations or other disturbances.
- Maintain initial curing temperature:
 - 16 to 27°C (60 to 80°F) for concrete with design strength up to 40 Mpa (6000 psi).

- 20 to 26°C (68 to 78°F) for concrete with design strength of 40 Mpa (6000 psi) or more.
- Prevent loss of moisture.

Method 1 – Initial cure in a temperature-controlled chest-type curing box

1. Finish the cylinder using the tamping rod, straightedge, float, or trowel. The finished surface shall be flat with no projections or depressions greater than 3.2 mm (1/8 in.).
2. Place the mold in the curing box. When lifting light-gauge molds be careful to avoid distortion (support the bottom, avoid squeezing the sides).
3. Place the lid on the mold to prevent moisture loss.
4. Mark the necessary identification data on the cylinder mold and lid.

Method 2 – Initial cure by burying in earth or by using a curing box over the cylinder

Note 2: This procedure may not be the preferred method of initial curing due to problems in maintaining the required range of temperature.

1. Move the cylinder with excess concrete to the initial curing location.
2. Mark the necessary identification data on the cylinder mold and lid.
3. Place the cylinder on level sand or earth, or on a board, and pile sand or earth around the cylinder to within 50 mm (2 in.) of the top.
4. Finish the cylinder using the tamping rod, straightedge, float, or trowel. Use a sawing motion across the top of the mold. The finished surface shall be flat with no projections or depressions greater than 3.2 mm (1/8 in.).
5. If required by the agency, place a cover plate on top of the cylinder and leave it in place for the duration of the curing period, or place the lid on the mold to prevent moisture loss.

Procedure – Transporting Specimens

- Initially cure the specimens for 24 to 48 hours. Transport specimens to the laboratory for final cure. Specimen identity will be noted along with the date and time the specimen was made and the maximum and minimum temperatures registered during the initial cure.
- Protect specimens from jarring, extreme changes in temperature, freezing, or moisture loss during transport.
- Secure cylinders so that the axis is vertical.
- Do not exceed 4 hours transportation time.

Final Curing

- Upon receiving cylinders at the laboratory, remove the cylinder from the mold and apply the appropriate identification.
- For all specimens (cylinders or beams), final curing must be started within 30 minutes of mold removal. Temperature shall be maintained at 23° ±2°C (73 ±3°F). Free moisture must be present on the surfaces of the specimens during the entire curing period. Curing may be accomplished in a moist room or water tank conforming to AASHTO M 201.

- For cylinders, during the final 3 hours before testing the temperature requirement may be waived, but free moisture must be maintained on specimen surfaces at all times until tested and ambient temperature is between 20 to 30°C (68 to 80°F).
- Final curing of beams must include immersion in lime-saturated water for at least 20 hours before testing.

Report

- On forms approved by the agency
- Pertinent placement information for identification of project, element(s) represented, etc.
- Sample ID
- Date and time molded.
- Test ages.
- Slump, air content, and density.
- Temperature (concrete, initial cure max. and min., and ambient).
- Method of initial curing.
- Other information as required by agency, such as: concrete supplier, truck number, invoice number, water added, etc.

This page intentionally left blank.

ATM 507 Field Sampling and Fabrication of 50 mm (2 in.) Cube Specimens using Grout (Non-Shrink) and or Mortar

Following are guidelines for the use of FOP for AASHTO R 64 by the State of Alaska DOT&PF.

1. Three specimens shall be cast for each test age required.
2. Applicable sections of AASHTO T 106 shall be followed for final curing, testing compressive strength and reporting test results.

This page intentionally left blank.

FIELD SAMPLING AND FABRICATION OF 50 MM (2 IN.) CUBE SPECIMENS USING GROUT (NON-SHRINK) AND OR MORTAR WAQTC FOP FOR AASHTO R 64

1. Scope

This method covers field sampling and fabrication and initial curing of 50 mm (2 in.) cube specimens of non-shrink grout and/or mortar materials.

The values stated in either SI or inch-pound units shall be regarded separately as standard. The inch-pound units are shown in brackets. The values stated might not be exact equivalents; therefore, each system must be used independently of the other.

Note 1: Unit weight was the previous terminology used to describe the property determined by this test method, which is mass per unit volume.

The text of this test method references notes and footnotes that provide explanatory information. These notes and footnotes (excluding those in tables) shall not be considered as requirements of this test method.

Warning—This standard does not purport to address all of the safety problems, if any, associated with its use. It is the responsibility of the user of this standard to establish appropriate safety and health practices and determine the applicability of regulatory limitations prior to use.

Warning—Fresh hydraulic cementitious mixtures are caustic and may cause chemical burns to skin and tissue upon prolonged exposure.

2. Referenced Documents

- ASTM C 1107 Standard Specification for Packaged Dry, Hydraulic-Cement Grout (Non-shrink)
- AASHTO T 106 / ASTM C 109 Test method for Compressive Strength of Hydraulic Cement Mortars (Using 50 mm or 2 in. Cube Specimens.)

3. Definitions

Fluid mix: Material fluid enough that little or no indentation will be left in the surface after puddling.

Plastic mix: Material viscous enough that an indentation will be left in the surface of the grout after tamping.

4. Apparatus

- Specimen Molds including cover plate (s): The 2 in. (50 mm) cube specimen molds shall be tight fitting and made of brass or other suitable material. This material shall not be susceptible to attack by the cement mortar. The molds shall have not more than three (3) cube compartments and shall be separable into not more than two (2) parts. The parts of the molds, when assembled, shall be positively held together. The cover plate(s) working surface shall be plane and shall be positively attached to the side walls of the mold. The interior faces of the molds shall conform to the tolerances of Table 1.

Table 1

Permissible Variations of Specimen Molds				
2 in. Cube Molds			50 mm Cube Molds	
Parameter	New	In Use	New	In Use
Planeness of Sides	<0.001 in.	<0.002 in.	<0.025 mm	<0.05 mm
Distance Between Opposite Sides	2 in. ± 0.005 in.	2 in. ± 0.02 in.	50 mm ± 0.13 mm	50 mm ± 0.50 mm
Height of Each Compartment	2 in. + 0.01 in. to -0.005 in.	2 in + 0.01 in. to -0.015 in.	50 mm + 0.25 mm to -0.13 mm	50 mm + 0.25 mm to -0.38 mm
Angle Between Adjacent Faces ^A	90 ± 0.5°	90 ± 0.5°	90 ± 0.5°	90 ± 0.5°

^A Measured at points slightly removed from the intersection. Measured separately for each compartment between all the interior faces and the adjacent face and between interior faces and top and bottom planes of the mold.

- **Tamper:** A non-absorptive, nonabrasive, non-brittle material such as a hard rubber compound having a Shore A durometer hardness of 80 ± 10. The tamper shall have a cross section of about 1/2 in. × 1 in. (13 mm × 25 mm) and a length of 5 in. to 6 in. (125 mm to 150 mm). The tamping face shall be flat and at right angles to the length of the tamper.
- **Trowel:** Steel bladed 100 to 150 mm (4 in to 6 in) in length, with straight edges.
- **Water tight container:** a 150 mm × 300 mm (6 in × 12 in) concrete cylinder mold with lid
- **Other Equipment:** Rubber gloves, scoop, clamps to secure the cover plate, light release oil for oiling the molds, small brush or lint-free cloth for applying and removing excess release oil, burlap or wrapping cloth capable of retaining moisture.

5. Sampling

1. Samples shall be obtained in accordance with WAQTC TM 2 when the batch equals or exceeds 1 m³ (1 yd³). When the batch is less than 1 m³ (1 yd³) sample from the batch after discharge. If remixing is required sample after remixing. Begin molding the specimens within an elapsed time of not more than 2 1/2 minutes from completion of the mixing.

Note 2: Use this test for grouts with 100% passing the 9.5 mm (3/8 inch) sieve.

2. Obtain a representative sample of the mix. Samples shall be a minimum size of 2000 g (4 lb) for each set of three (3) cubes to be fabricated.

6. Procedure

1. Assemble both portions of the mold and the bottom cover plate. All joints shall be water tight. If not water tight, seal the surfaces where the halves of the mold join by applying a coating of light cup grease (non water soluble). The amount should be sufficient to extrude slightly when the halves are tightened together. Repeat this process for attaching the mold to the bottom cover plate. Remove any excess grease. Apply a thin coating of release agent to the interior faces of the mold and the bottom cover plate. Wipe the mold faces and base plate as necessary to remove any excess release agent and to achieve a thin, even coating on the interior surfaces. Adequate coating is that which is just sufficient to allow a distinct fingerprint to remain following light finger pressure.
2. Place a layer of grout about 25 mm (1 in) (approximately one-half of the depth of the mold) in all of the cube compartments. Consolidated according to the consistency (plastic or fluid) of the mix.

- a. For plastic mixes, tamp the lift in four rounds of 8 tamps for a total of 32 tamps with the rubber tamper in 10 seconds. See Figure 1 for tamping sequence of each round. Rounds 1 and 3; and rounds 2 and 4 shall be the same.
 - b. For fluid mixes, puddle the lift 5 times with a gloved finger. See Figure 2 for puddling sequence.
3. Place the second lift in each of the cube compartments, slightly over-filling each compartment. Consolidate the material in the same fashion as the first lift with the additional requirement that during consolidation of the second lift any grout forced out onto the top of the mold after each round will be pushed back onto the compartment by means of the tamper and/or gloved fingers before the next consolidation round. When consolidation of the grout is completed, material should extend slightly above the top of the mold. Push any grout forced out onto the top of the mold after the last round back onto the compartment with the trowel.
 4. Smooth off the cubes by drawing the flat side of the trowel (with the leading edge slightly raised) once across the top of each cube at right angles to the length of the mold. Then, for the purpose of leveling the mortar and making the mortar that protrudes above the top of the mold of more uniform thickness, draw the flat trailing edge of the trowel (with leading edge slightly raised) once lightly along the length of the mold. Cut off the mortar to a plane surface flush with the top of the mold by drawing the straight edge of the trowel (held nearly perpendicular to the mold) with a sawing motion over the length of the mold. The material shall be flush with the top of the mold.
 5. Immediately secure the top cover plate to the cube mold.
 6. *Initial Curing* - Place the molds in a secure location away from vibration and as close as possible to the structure for initial curing. Cover with wet burlap, towels, or rags, seal it in a plastic sack in a level location out of direct sunlight, and record the time. These samples shall remain undisturbed and protected from freezing or overheating for a period of 24 to 28 hours.
 7. At the end of the initial curing period as required by the agency either;
 - a. Place the sealed plastic sack into a water tight container. Transport the cube samples immediately to the location of final curing. During transport, the cube samples shall be protected from jarring, freezing, and moisture loss.
 - b. Disassemble the mold and carefully remove the cube samples. Using a permanent marker, identify the cube samples. Handling the cube samples very carefully, wrap them in wet burlap or wet towels and place them into a water tight container. Transport the cube samples immediately to the location of final curing. During transport, the cube samples shall be protected from jarring, freezing, and moisture loss.

Final curing shall consist of immersing the cube samples in a lime-saturated water storage tank at a temperature of $23.0 \pm 2.0^{\circ}\text{C}$ ($73.5 \pm 3.5^{\circ}\text{F}$). They are to remain in the storage tank until time of test. (Curing cube samples of material other than hydraulic cement shall be in conformance with the manufacturer's recommendations.) The storage tank shall be made of non-corroding materials.

7. Report

- On forms approved by the Department
- Date
- Time
- Location, source and sampling method

- Quantity represented

Figure 1 – Plastic Mixes

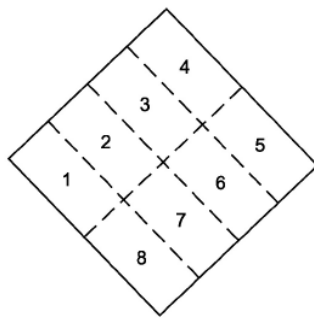

Rounds 1 and 3

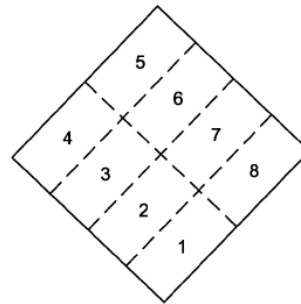

Rounds 2 and 4

Figure 2 – Fluid Mixes

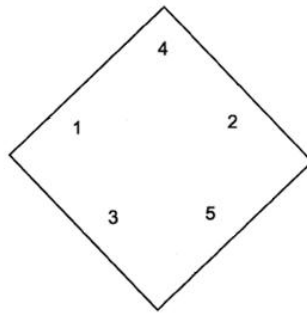

Puddling sequence

ATM 508 Slump Flow of Self-Consolidating Concrete

1. Scope

This procedure provides instructions for determining the slump flow of self-consolidating concrete (SCC) in accordance with ASTM C1611/C1611M.

Warning—Fresh Hydraulic cementitious mixtures are caustic and may cause chemical burns to skin and tissue under prolonged exposure.

2. Apparatus

- Cone: The SCC shall be placed in a slump cone mold conforming to the applicable requirements of ATM 503.
- Sample receptacle: Pan or wheel barrow that is water tight, has a non-absorbent surface, and large enough to retain a volume of concrete sufficient to perform all necessary testing and to fill all necessary sample specimen containers.
- Base plate: Flat, rigid, non-absorbent moistened surface having a minimum diameter of 915 mm (36 in.).
- Scoop or Pouring Vessel: A water tight container having a volume such that concrete is not spilled during placement in the mold.
- Strike-off bar: A flat straight steel bar, at least 3mm x 20 mm x 300 mm (1/8 x 3/4 x 12 inches), or plastic bar twice as thick as the steel bar.
- Tape measure or ruler with at least 5 mm or 1/4 in. graduations.

3. Procedure

1. Obtain the sample in accordance with ATM 501.

Note 1: Testing shall begin within five minutes of obtaining the sample.

2. Remix sample using shovel or scoop.
3. Dampen the inside of the cone and the base plate.
4. Place cone in center of leveled base plate, in the inverted position, as shown in Figure 1.

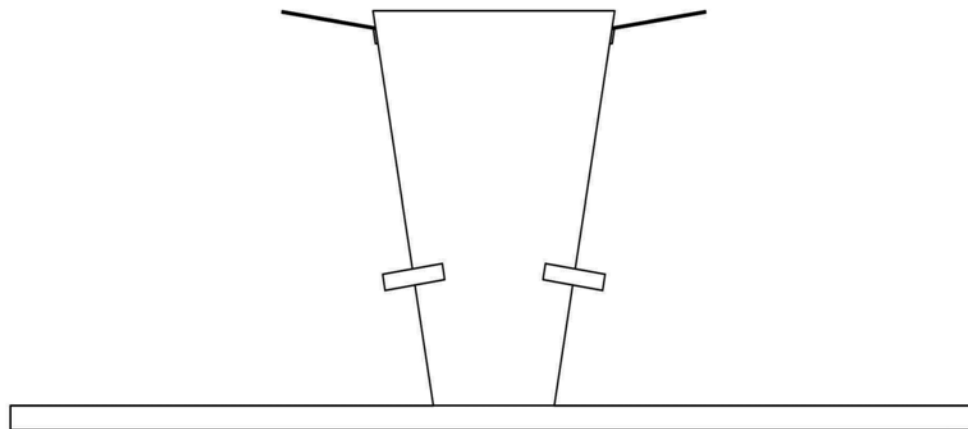

Figure 1

5. Fill the cone in one lift with a representative sample of concrete. Allow the concrete to flow into the cone without dropping the concrete from more than 5 inches above the inverted cone. Fill the cone slightly over full.

Note 2: Do not rod concrete. Do not tap or vibrate the cone. If concrete has been rodded, tapped, or vibrated discard sample, the test is invalid.

6. Strike off the top surface of concrete level with the top of the cone with a screeding motion of the strike-off bar.
7. Remove any spilled or struck off concrete from around the base of the cone so it does not inhibit the flow of the SCC mix.
8. Raise the cone vertically with a smooth fluid motion, without twisting or jerking, in 3 ± 1 seconds.

Note 3: Complete the entire test from the start of filling through removal of the cone without interruption within an elapsed time of 2 ½ minutes.

9. Wait for the concrete to stop flowing and then measure the largest diameter (d_1) of the resulting spread of concrete. When a halo is observed in the resulting circular spread of concrete, it shall be included as part of the diameter of the concrete. Measure a second diameter (d_2) of the circular spread of concrete at an angle approximately perpendicular to the first measured diameter (d_1). Measure the diameters to the nearest 5mm [1/4 in].

4. Calculation

Calculate the Slump Flow as follows:

$$\text{Slump flow} = (d_1 + d_2)/2$$

Where:

- d_1 = the largest diameter of the circular spread of the concrete, and
- d_2 = the circular spread of the concrete at an angle perpendicular to d_1 .

1. If the measurement of the two diameters differs by more than 50 mm [2 in.], the test is invalid and shall be repeated.
2. Record the average of the two diameters to the nearest 10 mm [1/2 in.].

5. Report

1. On forms approved by the Department
2. Date
3. Time
4. Location, source and sampling method
5. Quantity represented
6. Report the slump flow to the nearest 10 mm [1/2 in.].
7. Report visual segregation index (VSI) based on photos below; matching nearest photo.

Figure 2: Examples for visual inspection of slump flow.



VSI 0: Stable mix, no evidence of segregation or bleeding.



VSI 1: Stable mix, only slight bleeding.



VSI 2: Unstable mix, visible separation around edges (halo) and bleeding.



VSI 3: Unstable mix, visible halo around edges, segregation in middle, excessive bleeding.

ATM 509 Fabricating Test Specimens with Self-Consolidating Concrete

1. Scope

This procedure provides instructions for fabricating test specimens in the laboratory or field using a sample of freshly mixed self-consolidating concrete (SCC). This practice is applicable to SCC with a nominal maximum aggregate size of 25 mm [1 in.] and a slump flow of 500 mm [20 in.] or greater. If the slump flow is less than 500 mm [20 in.] follow the fabrication procedures described in the standard for which the test specimen is required.

Warning—Fresh Hydraulic cementitious mixtures are caustic and may cause chemical burns to skin and tissue under prolonged exposure.

2. Apparatus

- Cylinder Molds: Molds for casting SCC specimens shall conform to the requirements of ATM 506.
- Beam Molds: Molds for casting SCC specimens shall conform to requirements of ATM 506.
- Scoop or Pouring Vessel: A water tight container having a volume such that concrete is not spilled during placement in the mold.
- Strike-off bar, trowel or float.

3. Procedure

1. Obtain the sample in accordance with ATM 501.
2. After transporting sample to testing location remix sample using shovel or scoop.
3. Begin making specimens within 15 minutes of obtaining the sample.
4. Fill the mold with a representative sample of concrete. Slightly overfill by tilting the scoop and pouring the sample around the perimeter of the mold to allow the SCC to flow into the mold and to ensure an even distribution of concrete.

Note 1: Do not rod the concrete or tap the sides of the specimen mold.

Note 2: If slump flow is below 500 mm [20 in.] follow standard procedures for fabricating test specimens found in ATM 506.

5. After filling, strike off the mold with either the strike off bar, trowel or float. Cover specimens and immediately place on a flat, level surface for initial curing in accordance with ATM 506.
6. After initial curing, follow transporting and final curing procedures listed in ATM 506.

4. Report

- On forms approved by the Department
- Date and Time
- Location, source and sampling method
- Quantity represented

This page intentionally left blank.

ATM 520 Certified Precast Concrete Plant Program

1. Scope

This procedure covers the requirements for listing precast concrete products (products) on the Alaska Department of Transportation & Public Facilities (DOT&PF) Qualified Products List (QPL).

Note: QPL link: www.dot.state.ak.us/qploracle/#stage/advancesearch

2. References

Retain copies of the most recent AASHTO and ASTM test methods on file in the precast plant for each product produced and for the applicable quality control tests.

AASHTO Standards

- M 86M Concrete Sewer, Storm Drain, and Culvert Pipe
- M 170 Reinforced Concrete Culvert, Storm Drain, and Sewer Pipe
- M 199 Precast Reinforced Concrete Manhole Sections
- R 60 Sampling Freshly Mixed Concrete
- R 81 Static Segregation of Hardened Self-Consolidating Concrete (SCC) Cylinders
- T 22 Compressive Strength of Cylindrical Concrete Specimens
- T 23 Making and Curing Concrete Test Specimens in the Field
- T 24 Obtaining and Testing Drilled Cores and Sawed Beams of Concrete
- T 119 Slump of Hydraulic Cement Concrete
- T 121 Mass per Cubic Meter (Cubic Foot), Yield, and Air Content (Gravimetric) of Concrete
- T 152 Air Content of Freshly Mixed Concrete by the Pressure Method
- T 196 Air Content of Freshly Mixed Concrete by the Volumetric Method
- T 280 Concrete Pipe, Manhole Sections, or Tile
- T 309 Temperature of Freshly Mixed Portland Cement
- T 347 Slump Flow of Self-Consolidating Concrete (SCC)
- T 351 Visual Stability Index (VSI) of Self-Consolidating Concrete SCC)

ASTM Standards

- A615 Deformed and Plain Carbon-Steel Bars for Concrete Reinforcement
- C31 Making and Curing Concrete Test Specimens in the Field
- C39 Compressive Strength of Cylindrical Concrete Specimens
- C42 Obtaining and Testing Drilled Cores and Sawed Beams of Concrete
- C138 Mass per Cubic Meter (Cubic Foot), Yield, and Air Content (Gravimetric) of Concrete
- C143 Slump of Hydraulic Cement Concrete
- C172 Sampling Freshly Mix Concrete

- C173 Air Content of Freshly Mixed Concrete by the Volumetric Method
- C231 Air Content of Freshly Mixed Concrete by the Pressure Method
- C478 Circular Precast Reinforced Concrete Manhole Sections
- C497 Concrete Pipe, Concrete Box Sections, Manhole Sections
- C825 Precast Concrete Barriers
- C858 Underground Precast Concrete Utility Structures
- C913 Precast Concrete Water and Wastewater Structures
- C1064 Temperature of Freshly Mixed Hydraulic-Cement Concrete
- C1611 Slump Flow of Self-Consolidating Concrete
- C1758 Fabricating Specimens with Self-Consolidating Concrete
- C1776 Wet-Cast Precast Modular Retaining Wall Units
- D4101 Polypropylene Injection and Extrusion Materials

ATMM Test Methods

- ATM 530 Concrete Mix Designs by ACI & Packing Density Methods

3. Abbreviations and Definitions

Definitions for terms and abbreviations shall be according to the Department's Standard Specifications for Highway Construction, Section 101 and the following:

Abbreviations

- **ACPA.** American Concrete Pipe Association
- **ATM.** Alaska Test Method
- **ATMM.** Alaska Test Method Manual
- **NTPEP.** National Transportation Product Evaluation Program
- **NPCA.** National Precast Concrete Association
- **PCI.** Precast/Prestressed Concrete Institute
- **QA.** Quality Assurance
- **QAI.** Quality Assurance Inspector
- **QAE.** Quality Assurance Engineer
- **QC.** Quality Control
- **QCP.** Quality Control Plan
- **QPL.** Qualified Products List

Definitions

Addenda. Any addition or deletion to the QCP.

Audit. An inspection conducted by an independent party selected by the ACPA, NPCA, PCI or DOT&PF that verifies compliance with the Department's Certified Precast Plant Program

Plant. A precast concrete plant certified by ACPA, NPCA, PCI or DOT&PF according to ATM 520.

Quality Control Plan (QCP). Quality Control Plan for the plant that is site-specific and specifies the production, policies and procedures used by the plant. QCP includes materials testing frequencies of Table 1 & 2 items.

Qualified Products List (QPL). Qualified Products List is a compilation of products, sources, equipment, or other specified items approved for use on a Department Contract. The QPL includes the manufacturer (Certified Precast Concrete Plant) and date of the last audit for each product.

4. Significance and Use

Precast concrete products, meeting Contract requirements, along with the certified precast concrete plant (manufacturer) are included on the QPL.

5. Plant Personnel

Management Representative. The liaison with the Department responsible for all aspects of production and quality control required by the ATM 520.

Quality Control Technician. Certified as an ACI Concrete Field Testing technician, Grade I, or a WAQTC Concrete Testing Technician.

6. Materials

Provide materials incorporated into precast concrete products meeting the specifications of Table III and the following criteria:

- a. Chemical admixtures approved by the State Quality Assurance Engineer.
- b. Aggregates meeting requirements of ATM 530, Section 4. Aggregates.
- c. Cement approved by the State Quality Assurance Engineer.
- d. Manhole steps meeting the requirements of ASTM C478 and AASHTO M 199 with polypropylene conforming to ASTM D4101 and #4 (1/2") Grade 60 reinforcing bar conforming to ASTM A615.
- e. Pozzolans approved by the State Quality Assurance Engineer.
- f. Reinforcing steel sourced from a NTPEP Certified Manufacturer and meeting Buy America (FHWA funded projects) and Buy American (FAA and FTA funded projects) requirements.
- g. Welded wire reinforcement sourced from a NTPEP Certified Manufacturer and meeting Buy America (FHWA funded projects) and Buy American (FAA and FTA funded projects) requirements.
- h. Repair materials according to the QCP.

Materials Testing

Test aggregates used to make concrete for precast products at the frequencies required in the QCP and according to **Table 1**.

Table 1
Aggregate Tests

Test	Alaska Test Method	AASHTO Test Method	ASTM Test Method
Fine Aggregate			
Sticks and Roots Content	ATM 201		
Sodium Sulfate Soundness		T 104	C88
Material finer than #200 sieve by washing	ATM 304	T 11	C117
Organic Impurities		T 21	C40
Sieve Analysis of Aggregate	ATM 304	T 27	C136
Specific Gravity of Fine Aggregate		T 84	C128
Coarse Aggregate			
Sticks and Roots Content	ATM 201		
Sodium Sulfate Soundness		T 104	C88
Clay Lumps and Friable Particles		T 112	C142
Lightweight Pieces in Aggregate (Chert)		T 113	C132
Material finer than #200 sieve by washing	ATM 304	T 11	C117
Sieve Analysis of Aggregate	ATM 304	T 27	C136
Specific Gravity of Coarse Aggregate	ATM 308	T 85	C127
Los Angeles Abrasion		T 96	C131

The Plant shall test the precast products at the frequencies required in the QCP and according to **Table 2**.

Table 2
Precast Product Tests

Test	AASHTO Test Method	ASTM Test Method
Absorption	T 280	C497
Air Content (Pressure Method)	T 152	C231
Air Content (Volumetric Method)	T 196	C173
Super Air Meter (SAM) Number	T 395	
Compressive Strength	T 22	C39
Concrete Cores	T 24	C42
Making and Curing Concrete Specimens	T 23	C31
Sampling Concrete	R 60	C172
Slump	T 119	C143
Unit Weight	T 121	C138
Temperature	T 309	C1064
Slump Flow of Self-Consolidating Concrete (SCC)	T 347 & T 351	C1611
Fabricating Specimens with Self-Consolidating Concrete		C1758

Products

**Table 3
Design Specifications for Certified Precast Concrete Plant Products**

Products	Highway Specifications	Airport Specifications
Minor and Incidental Structure Products:	Section 550 Commercial Concrete^a	Item D-751 Manholes, Catch Basins, Inlets, and Inspection Holes
Curb and Gutter	Section 609 ^{a,b} , Subsection 550-2.03 ^b	
Manhole Sections	Section 604 ^{a,b} , Subsection 712-3.05 ^a Subsection 550-2.03 ^b ASTM C478, AASHTO M 199	Section 751-3.4^c Precast Concrete Structures
Headwall	Subsection 550-2.03^b	
Modular Retaining Wall Units	Subsection 550-2.03^b ASTM C1776	
Noise Wall Panels and Posts	Subsection 550-2.03^b	
Portable Barriers	Section 614 ^{a,b} Subsection 550-2.03 ^b ASTM C825	
Utility Structures; Cabinet Base (1) Load Center Base/Foundation, (2) Controller Base/Foundation, Junction Box, Similar Structures	Section 660 ^{a,b} Section 662 ^b , Subsection 550-2.03 ^b ASTM C858	
Water and Waste Water Structures; Catch Basin, Inlet Box, Outlet Box, Similar Structures	Subsection 550-2.03^b, ASTM C913	Section 751-2.8^c Precast Inlet Structures

a. Standard Specifications for Highway Construction

b. Central Region Special, Project Special

c. Standard Specifications for Airport Construction

Product Marking

Precast concrete products shall be marked with the date of manufacturing, **product** identification number, ACPA, NPCA, PCI, or DOT&PF-approved supplier certification identification marking, and the applicable Standard Specification required marking.

- The ACPA product marking shall be the "QCast" emblem or the words "ACPA Certified Product".
- The NPCA marking shall be the words "NPCA Certified Product".
- The PCI marking shall be the "PCI certification" emblem or the words "PCI Certified Product".

Quality Control Plan

Each Plant providing precast concrete products under the ATM 520 shall have a plant-specific written QCP that is the basis of control. The QCP shall contain, but not be limited to, the methods of production and quality control policies and procedures used by the plant. The QCP shall be according to ACPA, NPCA, or PCI Plant Certification requirements and **ATM 520**.

7. Certification

The Certified Precast Concrete Plant Program is a program whereby the Plant takes responsibility for the production of quality precast concrete products according to contract requirements, and the Department performs quality assurance inspections and audits the Plant's quality control procedures.

The Certified Precast Concrete Plant Program currently uses the **Auditor Checklist** from the **NPCA Quality Control Manual 15th Edition** as the basis for initial qualification of the products made by a precast plant that may be listed on the Qualified Products List (QPL).

Note: ACPA and PCI Auditor Checklists are also acceptable. The Auditor must meet NPCA, ACPA or PCI qualifications or be a Registered Professional Civil or Structural Engineer with a minimum of three years of experience in precast concrete design, quality assurance, or production.

Provide the DOT&PF State Quality Assurance Engineer:

- a. Copy of the compliance certificate issued by the auditing agency
- b. Copy of the completed Auditor Checklist
- c. Copy of the response to deficiencies of the audit (if applicable)
- d. Copy of the QCP
- e. List of products to be certified
- f. Management Representative name and contact information

The State Quality Assurance Engineer will notify the Management Representative of any deficiencies and provide instruction for listing approved products on the QPL.

The Plant shall provide a certificate of compliance with each shipment to a DOT&PF project meeting the contract requirements.

Change of Ownership

In the event of a change in ownership of the Certified Precast Concrete Plant, the certification shall expire on the date of such change. The new ownership may avoid expiration by submitting a statement to the State Quality Assurance Engineer, before legal transfer, indicating recognition of the details of the Program and verification that the plant is according to the ACPA, NPCA, PCI, or DOT&PF certification program requirements.

Independent Audit

Each Certified Precast Concrete Plant is required to submit to State Quality Assurance Engineer a copy of the annual independent party audit and their response to deficiencies of the audit, if applicable, to verify compliance with the ACPA, NPCA, PCI, or DOT&PF certification programs.

Submit the annual audit documents before the end of the calendar year or within 16 months of the last audit date for the product(s). Include the manufacturer (Certified Precast Concrete Plant) and date of the last audit for each product submitted for listing on the QPL.

All products produced by a plant will be removed from the QPL if the ACPA, NPCA, PCI, or DOT&PF audit documents are not submitted within 16 months. The products will be removed from the Qualified Products List for a minimum of 12 months.

- Disqualified precast products may be submitted for listing after 12 months of compliance to the ACPA, NPCA, PCI, or DOT&PF Certification program by the plant.
- Product listing is subject to review and compliance with ATM 520 Item 7, Certification.

8. Department Responsibilities

DOT&PF reserves the right to inspect, sample, test, conduct random audits and review documentation at any time to ensure compliance with this Program.

Plants shall grant QAI(s) access to all portions of the plant and storage area. The QAI will check compliance to ATM 520, the Plant's QCP and ACPA, NPCA, PCI, or DOT&PF program requirements, and DOT&PF specifications. The QAI will document any noncompliance items and report them in writing to the Plant.

Non-compliance items include material control, quality control inspection, final product testing and records documentation that do not conform to the Plant's QCP and ACPA, NPCA, PCI, or DOT&PF program requirements, or DOT&PF specifications.

The Department will conduct comprehensive annual audits of plants renewing DOT&PF Certification and will review annual audits done by other national plant certification agencies such as; ACPA, NPCA and PCI.

The Department will conduct bi-monthly Quality Assurance inspections of plants during their production season. Bi-monthly inspections include; an annual absorption test for manholes (ASTM C497), QA testing that parallels QC testing of fresh concrete by plant personnel, verification of correct steel grade, size, placement, and Buy America or Buy American records, concrete QC records since the previous inspection, safety meeting minutes, batch tickets, housekeeping records, current test standards, and aggregate management. QC test results that vary from QA test results by more than the tolerances listed in Table 11-1 of the current Alaska Construction Manual will be reported, investigated and the cause corrected by the QAI during the inspection when possible. Unresolved disputes between test results will be resolve by third party testing in an accredited laboratory with certified technicians.

The Department may conduct QA Inspections at the project site where precast products are installed.

When an inspection identifies deficiencies, and or changes to the QCP, submit a plan detailing methods to correct the deficiencies within 30 days of receiving the inspection report. Submit a revised QCP if the changes require it.

A Plant's product(s) may be removed from the QPL for failure to correct deficiencies identified by Quality Assurance Inspections.

The removal of a product from the QPL will be the responsibility of the State Quality Assurance Engineer. The product manufacturer may appeal removal of a product from the Department's Qualified Products List to the State Materials Engineer.

This page intentionally left blank.

ATM 530 Concrete Mix Designs by ACI & Packing Density Methods

1. Scope

This method describes Optimization of concrete aggregate blends and Volumetric Mix Design procedures for flowable and slip-formed Portland Cement concrete mixtures. This method is appropriate for design of concrete mixtures classified by STANDARD SPECIFICATIONS FOR HIGHWAY CONSTRUCTION under Section 501 Concrete for Structures as Class A or Class AA concrete and for all mixtures under Section 550 Commercial Concrete. This method conforms to the mix design process required by ACI 301, Specifications for Structural Concrete, Section 4, Concrete Mixtures. Flowable concrete applications include traditional ready-mix concrete such as sidewalks, floor slabs, fixed formed pavements, parking lots, walls, and pumpable concrete applications. Slip-formed paving includes curb and gutters, pavements, and highways that use a slip-formed paving machine. Combined Aggregate gradation bands are specified for flowable and slip-formed concrete mixtures. **Self-consolidating concrete combined aggregate gradation band is included for reference.** ACI 211 and Packing Density proportioning procedures are included in this method.

2. Significance

Concrete proportions, properties and performance are determined by the aggregate that forms most of the matrix of this composite material. For each sieve size the Tarantula Curve provides a recommended maximum retention limit and a suggested minimum retention limit. An adequate amount of coarse sand (#8 to #30) provides the cohesion properties of the concrete and reduces segregation. An adequate amount of fine sand (#30 to #200) provides the finishability, consolidation, and richness of a mixture. Historically many proportioning methods have been used to produce concrete. This method includes historic ACI 211 and newer Packing Density proportioning procedures.

3. Apparatus

- Ovens and hot plates thermostatically controlled to maintain the various required temperatures within $\pm 3^{\circ}\text{C}$ (5°F).
- Fresh Concrete Testing equipment for Slump, Air, Unit Weight, and Temperature, AASHTO T 119, T 152, T 121, and ASTM C1064/C respectively.
- Water tank with temperature at $23.0 \pm 1.7^{\circ}\text{C}$ ($73.4 \pm 3.0^{\circ}\text{F}$) per AASHTO T 85.
- Balance or scale: Capacity sufficient for the principal sample mass, readable to 0.1 g or 0.1 percent of the total sample mass and meeting the requirements of AASHTO M 231.
- Sieve shaker meeting the requirements of WAQTC FOP for AASHTO T 27/T 11.
- Specimen molds with lids, either 4x8" or 6x12" that conform to ASTM C470.
- Compression testing machine meeting the requirements of ASTM C39 and referenced documents.
- Surface Resistivity testing apparatus meeting the requirements of AASHTO T 358.
- Shrinkage testing apparatus meeting the requirements of ASTM C157.
- Air-entrained concrete maximum bubble spacing factor of 0.008 inch by ASTM C457 or AASHTO T 395, Sequential Air Method (SAM) number ≤ 0.20 on fresh concrete.

4. Aggregates

Combined Aggregate gradations must be within the Tarantula Curve boundary limits for each sieve size.as follows:

Tarantula Curve Combined Gradation Limits

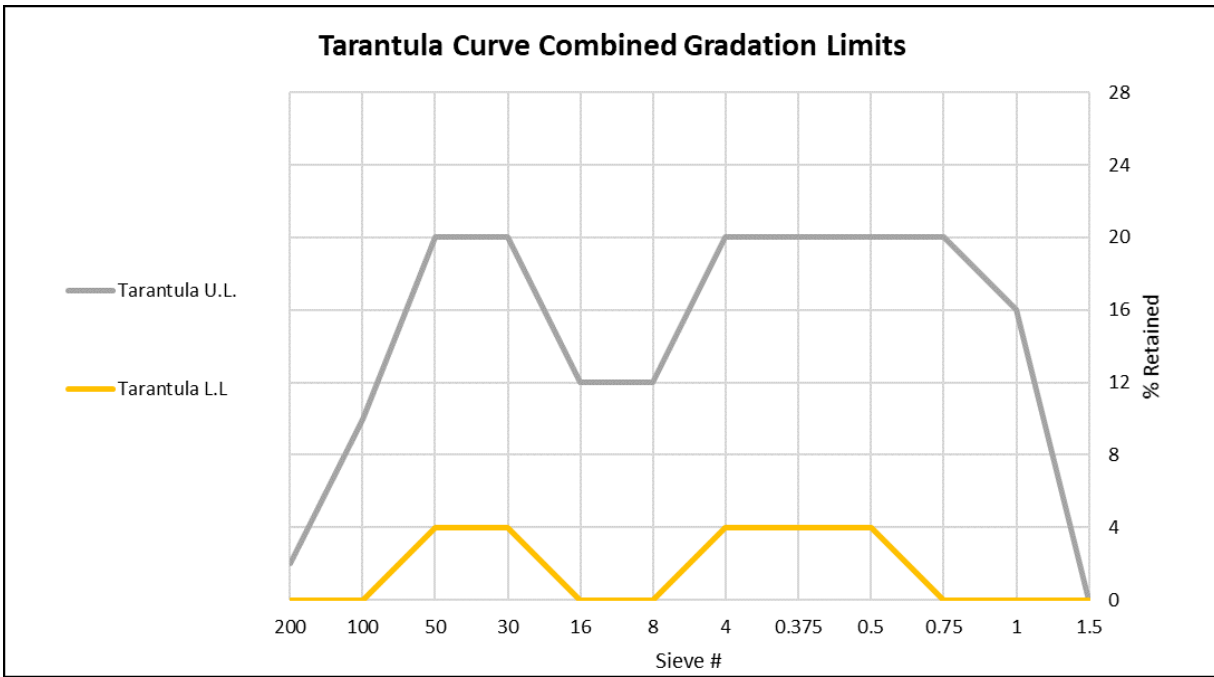

4.1. Perform gradations in accordance with AASHTO T 11 and T 27

4.1.1. Flowable Concrete Combined Gradation

Specified Aggregate Gradation for Flowable Concrete:

Sieve #	1.5	1	0.75	0.5	0.38	4	8	16	30	50	100	200
Tarantula U.L. (% retained)	0	16	20	20	20	20	12	12	20	20	10	2
Tarantula L.L. (% retained)	0	0	0	4	4	4	0	0	4	4	0	0

Flowable Concrete Sand Limits:

Coarse Sand % (#8-30) =	(Minimum is 20%)
Fine Sand % (#30-200) =	(Allowable range is 25-40%)

4.1.2. Slip-Formed Concrete Combined Gradation

Specified Aggregate Gradation for Slip-Formed Concrete:

Sieve #	1.5	1	0.75	0.5	0.38	4	8	16	30	50	100	200
Tarantula U.L. (% retained)	0	16	20	20	20	20	12	12	20	20	10	2
Tarantula L.L. (% retained)	0	0	0	4	4	4	0	0	4	4	0	0

Slip-Formed Concrete Sand Limits:

Coarse Sand % (#8-30) =	(Minimum is 15%)
Fine Sand % (#30 - 200) =	(Allowable range is 24-34%)

4.1.3. Self-Consolidating Concrete Combined Gradation

Specified Aggregate Gradation for Self-Consolidating Concrete:

Sieve #	1.5	1	0.75	0.5	0.38	4	8	16	30	50	100	200
Tarantula U.L. (% retained)	0	1	2	17	17	30	20	14	13	13	7	4
Tarantula L.L. (% retained)	0	0	0	10	10	23	13	6	5	5	3	0

Self-Consolidating Concrete Sand Limits:

Coarse Sand % (#8-30) =	(Minimum is 20%)
Fine Sand % (#30 - 200) =	(Allowable range is 25-40%)

4.2. Determine duplicate specific gravities (bulk, bulk SSD, apparent) and absorption values of each fine & coarse aggregate in accordance with AASHTO T 84 and T 85 respectively. Perform additional testing if duplicate values do not agree within 1s Single operator precision. The average of the duplicate test values shall be used in the mix design. (For “Example Calculations” see Appendix D worksheets for “*Duplicate Coarse Aggregate Specific Gravities and Absorption*” and “*Duplicate Fine Aggregate Specific Gravities and Absorption*”)

4.3. Perform Sodium Sulfate Soundness testing on both coarse (retained on #4 sieve) and fine (passing #4 sieve) aggregates or on coarse and fine fractions of the combined aggregate in accordance with AASHTO T 104. Maximum loss for coarse aggregate is 12% for sodium sulfate and 18% for magnesium sulfate. Maximum allowable loss for fine aggregate is 10% for sodium sulfate and 12% for magnesium sulfate.

4.4. Limit flat or elongated coarse aggregate to a maximum of 15% at a ratio of 1:3 according to ASTM 4791.

4.5. Limits for deleterious materials must conform to AASHTO M 80, Table 2, Class A, for coarse aggregates and AASHTO M 6, Table 2, Class A, for fine aggregates.

5. Cementitious Materials

Cementitious materials acceptable for concrete include, but are not limited to; Portland Cement, Calcium Sulfoaluminate Cement, Class C and F fly ash, micro-silica, nano-silica, natural pozzolans, ground granulated blast furnace slag (GGBF), silica fume, and meta-kaolin.

6. Admixtures

Admixture materials acceptable for concrete include, but are not limited to: water-reducers, surfactants, viscosity modifiers, air-entrainment agents, crack reducers, shrinkage reducers, accelerators, retarders, surface sealers, hardeners and finishing aides.

7. Fibers

Fiber materials acceptable for reinforcement, shrinkage and crack control in concrete include, but are not limited to; steel, stainless steel, synthetic, and alkali-resistant cellulose fibers.

8. Internal Curing

Internal curing may be used to increase tensile and compressive strength, reduce internal stresses and reduce shrinkage in concrete. Internal curing materials include, but are not limited to; expanded shale, clay or slate fine aggregates, alkali-resistant cellulose, super-absorbent polymers, multi-crystalline enhancer, specialty admixtures, and naturally occurring aggregates of volcanic origin meeting ASTM C1761.

9. Determination of Concrete Proportions by ACI 211.1 (See Appendix B)

1. Select slump appropriate for the type of construction
2. Select maximum size of aggregate so concrete can be placed without excessive segregation or voids.
3. Blend available aggregates to optimize the combined gradation as evaluated by gradation guidelines in section 4.1.1. or section 4.1.2
4. Estimate mixing water and entrained-air content for exposure class, selected slump and maximum aggregate size.
5. Select water-cementitious materials ratio needed to provide required durability and compressive strength.
6. Calculate the cementitious materials content based on steps 3-4 above.
7. Estimate coarse aggregate content using ACI 211.1 Table 6.3.6 - Volume of coarse aggregate per volume of concrete.

- Calculate fine aggregate content. At the end of step 7 all ingredients of the concrete have been estimated except the fine aggregate. The fine aggregate content is calculated by difference.

10. Determination of Concrete Proportions by Packing Density (See Appendix C)

- Select maximum size of aggregate so concrete can be placed without excessive segregation or voids.
 - Blend available aggregates to optimize the combined gradation as evaluated by gradation guidelines in section 4.1.1. or section 4.1.2
- Determine the volume of voids in the combined aggregate. (AASHTO T 19 / ASTM C29)
- Estimate the amount of excess paste required to provide desired workability.
- Calculate volume of paste required to fill the aggregate voids.
- Calculate volume of aggregates.
- Calculate weights of each aggregate.
- Select w/c ratio based on compressive strength requirements
- Calculate cement content.
- Calculate water content.
- Determine required entrained air content for exposure conditions and maximum aggregate size.

11. Trial Batches

See Appendix D, Example worksheets.

ACI 301, Specifications for Structural Concrete, Section 4, Concrete Mixtures states, “*Make at least three trial mixtures for each concrete class with a range of proportions that will produce a range of compressive strengths that will encompass f'_{cr} .*”

When designing air-entrained concrete a minimum of six trial mixtures is required. First proportion three NO AIR trial batches to achieve 1000 psi more than the strength required for the air-entrained mix. Appendix D, Example Mix Design, starts with design of a 4” slump, 5000 psi NO AIR mix to get a 4” slump, 4000 psi, $5 \pm 1.5\%$ air-entrained concrete mix. Appendix D includes seven sequential Excel worksheets followed by **twelve** sequential graphs that walk the user through the complete mix design process required by ACI 211 and ACI 301.

- Aggregate structure is the starting point for good concrete proportions, properties, and performance. Perform gradations on representative samples of each aggregate (or use the average gradation from screening plant control charts). Use worksheet 1-*Combined Aggregate Worksheet, Calcs, Graph*, to develop aggregate blend within the Tarantula Curve limits.
 - Use worksheet 2-*Duplicate Coarse Aggregate Specific Gravities & Absorption* for these tests.
 - Use worksheet 3-*Duplicate Fine Aggregate Specific Gravities & Absorption* for these tests.
 - Use worksheet 4-*Bulk Density and Voids in Aggregate* for these tests.
- Make a minimum of three trial batches of no-air concrete at three different cement contents and three different w/c ratios to establish w/c ratio vs. compressive strength. The constant paste method works well for preparing these batches. (For example: use 6.0 sack mix at 0.50 w/c, 6.5 sack at 0.45 w/c and 7.0 sack at 0.40 w/c.) Use worksheet 5-*Constant Paste Volume Calculations* for these calculations.
- Prepare first no-air trial batch with the lowest cement content (highest w/c ratio) that will provide a workable mix that is neither under-sanded nor over-sanded. Use a high water/cement ratio predictive of a

compressive strength just below the minimum required overdemand compressive strength (f'_{cr}). (For compressive strength of $f'_c = 5000$ psi, $f'_{cr} = f'_c + 1200$ psi or 6200 psi.) Make the first trial batch with the least amount of water-reducing admixture needed to get a 4 ± 1 " slump. (Note: Mix all subsequent batches to the same slump by adjusting the amount of water reducing admixture.) See worksheet *6-Mix Design Volumetric Data – 6 sk Trial 1* for example set of proportions with calculations.

4. When initial no-air trial batch mix parameters are satisfactory, proceed with two additional trial batches. Use the same aggregate amounts and paste volumes but higher cement contents and lower w/c ratios to obtain progressively higher strengths. In the example 6.0 sk Trial 1 has the highest w/c ratio (0.50) and the 28-day compressive strength of 6130 psi falls below minimum required compressive strength of 6200 psi, as desired. (See worksheet *7-Mix Design Compressive Strength & Unit Weight Data – 6 sk Trial 1*). Compressive strength of 6.5 sk Trial 2, w/c = 0.45, was 6550 psi, and compressive strength of 7.0 sk Trial 3, w/c = 0.40, was 7700 psi.
5. For air-entrained concrete make 3 additional batches at the highest strength limits (lowest w/c ratio) of the no-air data. Produce batches with air contents at optimum and at a little more than 1.5% above and below optimum to produce data covering the full range of acceptable air contents. This will provide sufficient data to produce a valid Strength vs. Entrained-Air relationship.

Determination of Fresh Concrete Properties

For each trial batch test temperature, slump (or slump flow if SCC mix), wet unit weight, and % air content.

Preparing Concrete Test Specimens

Cast 15 each 4x8" or 10 each 6x12" test cylinders for compressive strength testing of each trial batch. For Type I/II cement break 3 each 4x8" or 2 each 6x12" specimens at 3, 7, 14, 28 days and hold three specimens for possible break at a later age. (Note: High fly ash content concretes may continue to gain significant strength for several years. Additional test specimens should be cast for these mixes as compressive strength at 56 days, 90 days, 1 year and 2 years may be significant.) For Concrete made with Type III cement break 3 each 4x8" or 2 each 6x12" specimens at 1, 2, 3, 7 days and hold three specimens for possible break at a later age.

- When flexural strength criteria apply cast one set of three beams for each trial batch per AASHTO T 97 (ASTM C78).
- When maximum shrinkage criteria apply cast one set of shrinkage specimens for each trial batch per ASTM C157. Measure and record all data for each set of specimens and include it in mix design report.

Curing of Specimens

Cure compressive and flexural specimens in fog room or water bath as specified in ASTM C511

Determination of Hardened Concrete Properties

Remove test specimens from molds 24 ± 4 hours after casting. Determine hardened unit weight of all specimens by soaking test specimens in 23°C water for 15 minutes then weighing in water followed by weighing in air at SSD.

When concrete is subject to exterior environmental conditions, determine the Resistivity of each specimen by AASHTO T 358 no more than 24 hours prior to compression testing. Record specimen age at testing and resistivity for each specimen. Average each set of readings and include data in mix design reports.

When flexural strength is required cast three beams in accordance with ASTM C78, test at the required age and include dimensional, loading, and flexural strength data in mix design report.

When maximum shrinkage criteria apply test one set of restrained shrinkage specimens for each trial batch per ASTM C1581, measure and record required shrinkage data and include it in mix design report.

Graphing, Determination of Optimum w/c Ratio and Analysis of Test Results

1. Graph the 28 day (7 day for Type III cement) compressive strength vs. w/c ratio for the no-air trial batches. Graph the no-air compressive strength on the y-axis vs. w/c ratio on the x-axis and include a linear best-fit line through the data points. (See: *Graph 1-5000 psi NO AIR Strength vs. wc Ratio*).
2. For concrete that is not air-entrained determine the required overdesign and calculate f'_{cr} . Follow the required f'_{cr} value horizontally to the intercept with the strength vs. w/c ratio best-fit line. From this point drop a vertical line down to the w/c ratio on the x-axis and record the value. This is the maximum w/c ratio that will provide the required f'_{cr} . (See: *Graph 2-5000 psi NO AIR w line at $f'_{cr} = 6200$ psi*).
3. Graph the 28 day (7 day for Type III cement) compressive strength vs. air content for the three air-entrained batches made at the lowest w/c ratio (0.40) of the no-air batches. Provide the best-fit, linear equation for the data such that strength may be calculated as a function of air content. (See: *Graph 3-Compressive Strength vs % Air at 0.40 wc*).
4. On Graph 3, draw a vertical line from the optimum air content (5.0%) on the x-axis up to where it intersects the air vs. strength line. From that point draw a horizontal line across to the strength (y) axis and record the compressive strength (5760 psi) at 5% air. (See: *Graph 4-Compressive Strength at 5% Air*).
5. Plot this point (5760 psi @ 5% air) on Graph 1, the no-air strength vs. w/c ratio graph to create Graph 5. (See: *Graph 5-5760 psi point (0.40 wc, 5% air) w NO AIR line*).
6. On Graph 5 (the no-air strength vs. w/c ratio graph containing the optimum air point compressive strength) draw a line through this point parallel to the no-air strength line to make Graph 6. (See: *Graph 6-Line thru 5760 psi point parallel to NO AIR line*).
7. On the y-axis of Graph 6 draw a horizontal line through 5200 psi, the required over-design strength (f'_{cr}) for the air-entrained concrete, that intersects air-entrained strength vs. w/c ratio line. (See: *Graph 7- f'_{cr} line meets 5% Air Strength vs wc*).
8. From the intersection of the horizontal $f'_{cr} = 5200$ psi line with the air-entrained strength vs. w/c ratio line on Graph 7, drop a vertical line down to the w/c (x) axis. (See: *Graph 8-Max wc=0.435 for $f'_{cr}=5200$ psi w 5% Air*) Record this w/c ratio (0.435) as the maximum allowed for the air-entrained mix design.

The point (w/c, f'_{cr}) will provide the critical proportions for the submitted mix design and for a proof batch by the owner agency. (Note: DOT&PF may require materials for a proof batch to verify concrete mixes made from material without a previous history.)
9. Plot Strength vs. Age data for the three NO AIR trial batches as shown on “*Graph 9-NO AIR Strength vs Age - 3 cement contents.*”
10. Plot Strength vs. Age data for the four 5% Air trial batches as shown on “*Graph 10-5% Air Strength vs Age - 4 cement contents.*”
11. Include a graph of Mix Design Unit Weight vs. % Air for the final selected mix proportions. (See: *Graph 11-Mix Design Unit Weight vs % Air w 2s Limits*).
12. Include a graph of 28-day Compressive Strength vs. Gravimetric % Air for the final selected mix proportions. (See: *Graph 12-strength vs, % Air, 7sk, wc 0.41*)
13. Consecutive strength data may provide the basis for reductions or increases in cement content as strength data is accumulated on a new mix design. If 15-30 consecutive strength tests justify reduction in the initial over-design strength (f'_{cr}) according to ACI 301 Sections 4.2.3.2 through 4.2.3.6c then the concrete producer or supplier may submit a request to lower the cement content. Include consecutive strength test data with any request for consideration of cementitious reduction.

Conversely, if strengths are below f'_{cr} or if there is high variability in strength tests, then the engineer may request an increase in the cement content.

Note: Graphs of w/c vs. compressive strength and entrained-air vs. compressive strength provide design and construction personnel with valuable strength information for acceptance/rejection decisions should concrete arrive at the job site that is outside w/c or entrained-air limits. A theoretical percent air vs. unit weight graph provides a good check of pressure type air meter reading.

12. Report

Include the following:

1. Project identification, Source/Supplier of mix and name of the general contractor when mix design is specific for a single project.
2. Aggregate source(s), quality identification(s), target gradation of each aggregate, blend ratio of individual stockpiles, individual aggregate absorption values, apparent, bulk SSD, and bulk specific gravities. For blended Aggregate sources, screen and test Coarse and Fine Fractions. Other properties that may be specified such as; Unit Weight of dry-rodded coarse aggregate, fineness modulus of the blended fine aggregate, percent flat and elongated; sodium sulfate soundness of coarse and fine aggregate fractions, or aggregate-silica reactivity (ASR).
3. Gradation for each aggregate stockpile with graphical representation on Tarantula Curve of the combined aggregate gradation. AASHTO M 6 and M 43 gradations for ACI 211.1 mixes. Include Lower Specification Limit (LSL) and Upper Specification Limit (USL) data with both combined and ACI gradations.
4. An orderly presentation of all trial batch data including; type(s) and source certificate with chemical oxide analysis for all cementitious materials, trial batch proportions, complete test cylinder data with unit weight of all cylinders determined immediately after initial curing period and removal from molds, surface resistivity (when required) of test cylinders, with nominal cylinder size indicated, just before compressive testing, compressive strength and average compressive strength at each age.

Include graphs of Compressive strength vs. w/c Ratio and Compressive strength vs. Air content (for air-entrained mixes). Plot trial batch data points on graph(s) along with best-fit linear trend line. For trial batch nearest to selected mix design proportions plot Strength vs. Age points and the best-fit smoothed curve through the data points.

Plot the wet unit weight (D) versus air contents of 0% to 10% from the theoretical unit weight (T) using ASTM C138, Sec 7.6, Equation (7), $A = [(T - D)/T] \times 100$, Where: A = % Air, D = Wet Unit Weight, and T = Theoretical Maximum Unit Weight.

5. Identification and address of the laboratory that performed the mix design, mix design identification number, and the signed seal of the professional engineer who reviewed and approved the mix design.

Appendix A

Definitions

Absolute Volume – Solid volume of a material exclusive of all particle void spaces. This is calculated by the following formula:

$$\text{Absolute Volume (Cubic Feet)} = \text{Weight of Material} / (\text{Specific Gravity} \times 62.4)$$

For example: A sack of Portland cement occupies a bulk volume of approximately 1 cubic foot. The absolute volume is about 0.478 cubic foot.

$$94 \text{ lbs} / (3.15 \times 62.4 \text{ lbs/ft}^3) = 0.478 \text{ cubic foot}$$

Specific Gravity – A ratio expression of the weight in air of an absolute volume of material to the weight of an equal volume of water.

Fineness Modulus (FM) – An empirical factor obtained by adding the total percentages of a sample of fine aggregate retained on each of the following sieves, that sum divided by 100.

For example:

Sieve numbers 4, 8, 16, 30, 50, 100

<u>Sieve Size</u>	<u>% Passing</u>	<u>% Retained</u>
#4	98	2
#8	90	10
#16	68	32
#30	42	58
#50	20	80
#100	6	94
		Sum = 276

Fineness Modulus calculation: $276 / 100 = 2.76$

Theoretical Density of Concrete (T) - The density of a concrete mixture at 0% air content. Usually determined during the mix design process.

Appendix B

Example Calculations for ACI 211.1 Method

1. Select an appropriate value of slump from ACI Table 6.3.1
(Use **3 inch slump for this example**)
2. Choose a nominal maximum size of coarse aggregate based on guidelines in ACI section 6.3.2
(Use **¾ inch for this example.**) Include gradation conforming to AASHTO M 43 size 67 for ¾ to #4)
3. Blend available aggregates to optimize the combined gradation as evaluated by gradation guidelines in section 4.11 or section 4.1.2
4. Estimate mixing water and air content per cubic yard of concrete based on ACI section 6.3.3 and Table 6.3.3
(Use **305 pounds of water for exterior concrete with air-entrainment, and select 6% air for severe exposure**)
5. Select w/c ratio to give desired strength per ACI 6.3.4 and Table 6.3.4a
(Assume **4000 psi required compressive strength and select 0.48 for the w/c ratio**)
6. Calculate the cement content in pounds per cubic yard of concrete, ACI 6.3.5, as follows:
(**305 pounds / 0.48 = 635 pounds cement**)
7. Estimate coarse aggregate content, ACI 6.3.6 and Table 6.3.6
 - a. In this example use $FM = 2.76$ for fine aggregate with ¾ inch coarse aggregate to get a coarse aggregate bulk volume fraction of **0.62**
 - b. Use ASTM C29 to determine Bulk Unit Weight of coarse aggregate. Assume **102 pounds/ft³** for this example.
 - c. For one cubic yard batch proportions coarse aggregate = $0.62 (27 \text{ ft}^3/\text{yd}^3) (102 \text{ lbs}/\text{ft}^3)$
(**Weight of coarse aggregate = 1707 pounds/yd³**)
8. At the completion of step 7 all ingredient amounts are known except for the fine aggregate, which is determined by difference, ACI 6.3.7, using the volumetric method. Use specific gravity of 2.68 for coarse aggregate (CA) and 2.71 for fine aggregate (FA). Include FA gradation meeting AASHTO M 6.
 - a. Volume of water: $= 305 \text{ lbs} / 62.4 \text{ lbs}/\text{ft}^3 = 4.89 \text{ ft}^3$
 - b. Solid Volume of cement: $= 635 \text{ lbs} / (3.15 \times 62.4 \text{ lbs}/\text{ft}^3) = 3.23 \text{ ft}^3$
 - c. Solid Volume of CA $= 1707 \text{ lbs} / (2.68 \times 62.4 \text{ lbs}/\text{ft}^3) = 10.21 \text{ ft}^3$
 - d. Volume of air $= 0.06 \times 27.0 \text{ ft}^3 = 1.62 \text{ ft}^3$
 - e. Subtotal of all ingredients except fine aggregate $= 19.95 \text{ ft}^3$
 - f. Solid Volume of FA $= 27 - 19.95 = 7.05 \text{ ft}^3$
 - g. Required weight of dry FA $= 7.05 \text{ ft}^3 \times 2.71 \times 62.4 \text{ lbs}/\text{ft}^3 = 1192 \text{ lbs.}$
9. Follow ACI 211.1 Sections 7.2.8 to 7.3.10 for adjustments for aggregate moisture, slump, workability and mix harshness.

Appendix C

Example Calculations for Packing Density Method

1. Select the maximum size aggregate to minimize segregation and voids.
2. Create maximum density aggregate blend from available sources. (see section 4.1.1 or 4.1.2 in method)
3. Use AASHTO T 19 /ASTM C29 to determine Bulk Unit Weight of combined aggregate and then calculate the volume of voids in one cubic yard.

$$\text{Packing density} = \mathbf{0.7223}$$

$$\text{Voids content} = 1 - 0.7223 = \mathbf{0.2777}$$

4. Estimate the amount of excess paste required to provide desired workability.

$$\text{Excess paste for 3" slump} = \mathbf{10\%}$$

5. Calculate the total amount of paste required.

$$\text{Paste content} = 0.2777 + 0.10 \times 0.2777 = \mathbf{0.3054}$$

6. Calculate Volume of aggregates.

$$\text{Volume of aggregates} = 1 - 0.3054 = \mathbf{0.6945}$$

7. Calculate weights of each aggregate assuming a three-aggregate blend of 42% CA, 18% IA, and 40% FA with specific gravities of 2.712, 2.736, and 2.593 respectively.

$$\text{Solid Volumes of Aggregates} = 0.42 / 2.712 + 0.18 / 2.736 + 0.40 / 2.593 = \mathbf{0.3749}$$

$$\text{CA} = (0.6945 / 0.3749) \times 0.42 \times 62.4 \text{ lbs/ft}^3 \times 27 \text{ ft}^3/\text{yd}^3 = \mathbf{1311 \text{ lbs/yd}^3}$$

$$\text{IA} = (0.6945 / 0.3749) \times 0.18 \times 62.4 \text{ lbs/ft}^3 \times 27 \text{ ft}^3/\text{yd}^3 = \mathbf{562 \text{ lbs/yd}^3}$$

$$\text{FA} = (0.6945 / 0.3749) \times 0.40 \times 62.4 \text{ lbs/ft}^3 \times 27 \text{ ft}^3/\text{yd}^3 = \mathbf{1248 \text{ lbs/yd}^3}$$

8. Select w/c ratio to give desired strength.

9. Calculate cement content:

(Assume 4000 psi required compressive strength and select 0.48 for the w/c ratio)

$$w/c = 0.48; \quad w = 0.48c$$

$$\text{Total paste} = c + w = c/3.15 + 0.48c/1 = 0.7975c$$

$$\text{Cement content} = 0.3054/0.7975 \times 62.4 \text{ lbs/ft}^3 \times 27 \text{ ft}^3/\text{yd}^3 = 645 \text{ lbs/yd}^3$$

10. Calculate water content:

$$\text{Water content} = 0.48 \times 645 \text{ lbs/yd}^3 = 310 \text{ lbs/yd}^3$$

11. Adjust for aggregate moisture, slump, workability and mix harshness and entrained air.

Appendix D

1. Combined Aggregate Worksheet Tarantula Curve Data Entry & Graphical Plot: Flowable Concrete

Mix design or batch ID: Flowable Example xyz

Date: 4/3/2023

Enter Aggregate SSD Weights under BLEND SUPPLIED below.

Note: Blue font is data entry, Red font indicates a calculation cell

BLEND SUPPLIED							
Aggregate Sizes:	1.5"	1"	3/4"	Pea	Pea - Sand	F. Sand	Totals
SSD Weights (lbs)	0	0	1,762	0	0	1,417	3,179
Mass % Each Size	0.0%	0.0%	55.4%	0.0%	0.0%	44.6%	100.0%

Enter Aggregate Gradations:

SIEVE SIZE		CURRENT GRADATIONS, PERCENT PASSING						Combined % Passing	Combined % Retained
(us)	(mm)	1.5"	1"	3/4"	Pea	C. Sand	F. Sand		
1.5"	37.5	100	100	100	100	100	100	100.0	0.0
1.0"	25	0	0	100	100	100	100	100.0	0.0
3/4"	19	0	0	95	100	100	100	97.2	2.8
1/2"	12.5	0	0	74	100	100	100	85.6	11.6
3/8"	9.5	*	0	55	0	100	100	75.1	10.5
#4	4.75	*	0	10	0	0	100	50.1	24.9
#8	2.36	*	0	5	0	0	84	40.2	9.9
#16	1.18	*	*	4	0	0	60	29.0	11.3
#30	0.60	*	*	3	0	0	38	18.6	10.4
#50	0.30	*	*	2	0	0	18	9.1	9.5
#100	0.15	*	*	1	0	0	6	3.2	5.9
#200	0.075	0	0	1.0	0	0	2.8	1.8	1.4
Pan	0.000								1.8
Total:								100.0	

Concrete Sand Limits - Flowable	Coarse/Fine Percentage	Within Limits?
Coarse Sand % (#8-30) = <i>Minimum is 20%</i>	31.5	Yes
Fine Sand % (#30-200) = <i>Allowable range is 25-40%</i>	27.2	Yes

Tarantula Limits - Flowable		
Sieve #	Tarantula U.L.	Tarantula L.L.
1.5	0	0
1	16	0
0.75	20	0
0.5	20	4
0.375	20	4
4	20	4
8	12	0
16	12	0
30	20	4
50	20	4
100	10	0
200	2	0

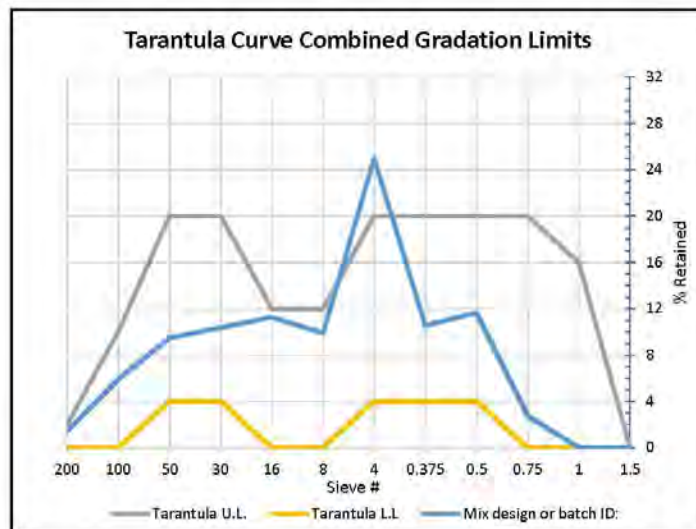

2. Duplicate Coarse Aggregate Specific Gravities & Absorption

AASHTO T 85 (ASTM C127) Duplicate Relative Density, (SpG) and Absorption of Coarse Aggregate				
Client:		Project: Example		
Client Address:		Material/Use:	Submitted by:	
Source:		Sampled from:	Field Number:	
Test Location:		Sampled by:	Date Sampled:	
Depth:		Received by:	Date Received:	
Quantity Rep:		Testing Tech:	Project No:	
		Date Completed:	Lab Number:	
Sample Preparation:				
Use table below to determine sample size. If more than 15% retained on 1-1/2" sieve, test this portion separately from the smaller material. Multiple fractions may be used. Sieve the reduced sample over a #4 sieve and wash all dust from the sample.				
Procedure:				
1. Dry to constant mass at 110 ± 5°C. Cool at room temperature for 1-3 hrs. or until sample can be handled comfortably.				
2. Completely submerge sample in water at room temperature and soak for 15-19 hrs. (ASTM 24 ± 4 hrs.)				
<i>Note: AASHTO allows initial drying to be eliminated if aggregate will be used in concrete mixtures in it's naturally wet condition. The 15 hour soaking period may be eliminated if surfaces of the sample have been kept continuously wet until the test was begun.</i>				
3. Tare wire bucket and handling scoop in preparation for submerging sample. Insure water bath is at overflow level.				
4. Record temperature of water bath, verifying it is 23 ± 1.7°C (23 ± 2°C for ASTM).				
5. Remove sample from water and roll in absorbent towel until no visible water sheen. Place in handling scoop.				
6. Immediately record mass of sample in air, at SSD condition, to minimize loss from evaporation. (B)				
7. Place sample in wire bucket attached to scale in water bath. Shake the bucket to release trapped air bubbles.				
8. Record mass of sample while submerged. (Be sure to return handling scoop to top of scale or tare will be off.) (C)				
9. Dry to constant mass at 110 ± 5°C. Cool at room temperature 1-3 hr until sample can be handled comfortably.				
10. Record oven dry mass. (A)				
<i>Note: Report Sp.G results to 0.001 (AASHTO) 0.01 (ASTM)</i>				
Formulas:	Description:	Trial 1	Trial 2	Average
A	Oven dry mass in air (g)	2869.0	2892.6	
B	SSD mass in air (g)	2907.8	2933.5	
C	Mass in water (g)	1820.8	1836.2	
T	Temperature ©	23.4	23	
A/(B-C)	Bulk Sp.G (oven dry)	2.639	2.636	2.638
B/(B-C)	SSD Sp.G	2.675	2.673	2.674
A/(A-C)	Apparent Sp.G	2.737	2.738	2.738
100[(B-A)/A]	% Absorption	1.35%	1.41%	1.38%
Sample Size Table		Notes:		
Nominal Max. Size, mm (in.)	Min. Test Sample Mass, kg (lb.)			
12.5 (1/2) or less.	2 (4.4)			
19.0 (3/4)	3 (6.6)			
25.0 (1)	4 (8.8)			
37.5 (1 1/2)	5 (11)			
50 (2)	8 (18)			
63 (2 1/2)	12 (26)			
75 (3)	18 (40)			
90 (3 1/2)	25 (55)			
100 (4)	40 (88)			

3. Duplicate Fine Aggregate Specific Gravities & Absorption

AASHTO T 84 (ASTM C128) Duplicate Relative Density, (SpG) and Absorption of Fine Aggregate				
Client:	Project: Example			
Client Address:	Material/Use:	Submitted by:		
	Sampled from:	Field Number:		
Source:	Sampled by:	Date Sampled:		
Test Location:	Received by:	Date Received:		
Depth:	Testing Tech:	Project No:		
Quantity Rep:	Date Completed:	Lab Number:		
Sample Preparation:				
1. Obtain 2 each, 1kg samples in accordance with T 2 (D 75) and T 248 (C 702) for duplicate tests.				
2. Dry to constant mass then add a minimum of 6% moisture after cooling. Allow sample to stand 15-19 hrs. (24 ± 4 hrs. for ASTM).				
a) Initial drying is optional if aggregates will be used for concrete mixtures, and are still in their moist states				
3. Decant excess water with care to avoid loss of fines. Spread sample on nonabsorbent surface, and position sample in gently moving warm air. On short table use fan, heat lamp, and spatula to speed up evaporation during the drying process.				
4. Press cone mold to a nonabsorbent surface and fill to overflowing, heaping additional material above top of mold by holding it with cupped fingers of hand holding the mold.				
Keep constant pressure on mold, use tamper to deliver 25 blows to aggregate, letting tamper fall under its own weight from approximately 0.2 in. (5mm) above the top surface of the aggregate				
5. Clear the area around the mold and remove the cone, being careful not to agitate the material.				
a) Slight slumping of the material indicates SSD; retention of the molded shape indicates surface moisture.				
b) Slumping after striking the table indicates the cone test should be run again immediately				
6. Repeat steps 4-5 until material reaches SSD. Start filling pycnometer immediately after reaching SSD.				
Note: Angular aggregate, samples containing large proportions of fines may require provisional procedures.				
<i>To test, drop a handful of material 100-150 mm - airborne fines indicate this situation.</i>				
Procedure: (Bold letters indicate data entry points)				
1. Partially fill, (1/4), the calibrated pycnometer with water, insert funnel with tube, and tare.				
2. Introduce 500 ± 10 grams of prepared SSD material into flask. Record the mass of material to 0.1 g (S).				
3. Fill flask to approx 90% capacity with additional water, manually agitate 15-20 min to remove visible air				
a) Manually agitate by rolling on rubber pad or between your hands.				
Note: A small amount of isopropyl alcohol may be used to disperse the foam.				
4. Adjust the temperature of the pycnometer and contents to 23.0 ± 1.7°C (23.0 ± 2.0°C for ASTM) (T).				
5. Bring the water level to the calibrated mark. The bottom of meniscus should rest on the calibrated line.				
6. Record mass of pycnometer, sample, and water to 0.1 g (C).				
7. Select the mass of the pycnometer and distilled water from the current calibration sheet (B).				
8. Empty the entire sample into a pan and dry to constant mass, (within 0.1 g), using 110°C oven (A).				
a) Use a wash bottle to rinse all the fines from the pycnometer.				
b) Determine the mass of the sample only after it has cooled 1.0 ± 0.5 hrs.				
Note: Report SpG. Results to 0.001 (AASHTO) 0.01 (ASTM)				
Formulas:	Description of data or calculation:	Trial 1	Trial 2	Average
B	Pyc+ Distilled Water (from callb) Ave M pw, c (g)	660.7	660.7	
S	SSD Soil Mass	500.1	500.8	
C	Pyc + Distilled Water + Agg	973.7	974.5	
T	Temperature (23.0 ± 2.0°C)	23.0	22.7	
A	Oven Dry Mass	493.4	495.3	
A/(B+S-C)	Bulk Sp.G. (Oven Dry)	2.637	2.649	2.643
S/(B+S-C)	SSD Sp.G.	2.673	2.678	2.675
A/(B+A-C)	Apparent Sp.G.	2.735	2.729	2.732
100(S-A)/A	Absorption	1.36%	1.11%	1.23%

4. Bulk Density and Voids in Aggregate

Bulk Density ("Unit Weight") and Voids in Aggregate AASHTO T19 / T19 M and ASTM C29 / C 29M					
Client:		Project: Example			
Client Address:		Material/Use:		Submitted by:	
Source:		Sampled from:		Field Number:	
Test Location:		Sampled by:		Date Sampled:	
Depth:		Received by:		Date Received:	
Quantity Rep:		Testing Tech:		R&M Project No:	
		Date Completed:		Lab Number:	
Sample Preparation:					
Obtain sample 125-200% of quantity required to fill measure. Dry to constant mass at 110 ± 5°C.					
Method A - Rodding: (For nominal maximum size 1 1/2" or less)					
1. Record weight of measure to 0.1 lb.					
2. Fill measure 1/3 full and level surface with fingers. Rod layer 25 times with a 5/8" hemispherical tipped rod. Avoid hitting bottom of measure.					
3. Fill measure 2/3 full, level, and rod 25 times. Avoid penetrating the first layer.					
4. Fill measure to overflowing and rod again. Avoid penetrating the previous layer.					
5. Level aggregate using fingers or straight edge so projections above measure balance surface voids.					
6. Record weight of full measure to 0.1 lb.					
Method B - Jigging: (For nominal maximum size 1 1/2" to 5")					
1. Record weight of measure to 0.1 lb.					
2. Fill measure 1/3 full and level surface with fingers. Placing measure on a solid base, compact by raising opposite sides alternately about 2" and dropping. Drop each side 25 times for a total of 50 blows per layer.					
3. Fill measure 2/3 full, level, and compact as above.					
4. Fill measure to overflowing and compact as above.					
5. Level aggregate using fingers or straight edge so projections above measure balance surface voids.					
6. Record weight of full measure to 0.1 lb.					
Method C - Shoveling: (Loose Bulk Density - use only if specified)					
1. Record weight of measure to 0.1 lb.					
2. Fill measure to overflowing with shovel or scoop, discharging from no more than 2" above measure. Avoid segregation of material.					
3. Level aggregate using fingers or straight edge so projections above measure balance surface voids.					
4. Record weight of full measure to 0.1 lb.					
Bulk Density SSD - For bulk density SSD, use this same procedure but calculate using M _{ssd} formula below. Note - Absorption and SpG data must be determined using C127 or C128 (fine or coarse SpG tests)					
Method Used:		A		Trial Number:	
Formula:	Description:	1	2	3	Avg.
G	Wt. of Agg. + T (lb)	39.49			-
T	Wt. Tare (lb):	7.718			-
V	Volume(ft ³):	0.248			-
$M = (G-T)/V$	Bulk Density (lb/ft ³) (M)	128			128
A	% Absorption	0.58			-
$M[1+(A/100)]$	Bulk Density at SSD (lb/ft ³) (M_{ssd})	129			129
S	Bulk SpG (dry basis)	2.754			-
W	Water density 62.4 lb/ft ³)	62.4			-
$100[(S*W)-M]/(S*W)$	% Void Content	25.5%			25.5%
Notes:					

5. Constant Paste Volume Calculations

Constant paste volume calculations for high, intermediate and low w/c trial batches :

Blue font indicates data entry points

Red font indicates a calculation, **No** data entry in these cells

1. Start with three w/c ratios 0.05 apart and three cement contents about 1/2 sack of cement apart.
2. For example: Enter w/c = 0.50, 0.45, 0.40 and cement = 6.0, 6.5, 7.0 sack respectively (see below)
3. Enter Cement mass (lb) based on the estimated number of sacks per cubic yard for each of the three mixes.
4. Calculate *Total Paste Volume* at middle w/c ratio of 0.45 (6.5 sack mix) by adding cement and water volumes.
(Note: Goal is to match the middle Paste Volume with the High and Low w/c ratio batches.
Start with highest w/c ratio in top box below. Follow instructions to the right of Total Paste Volume cell.)
5. From "Home" in Excel select "Data" tab, then select "What-If Analysis", then "Goal Seek" from drop-down menu.
6. To "Set cell" select the "Total Paste Volume" cell for the high w/c ratio mix.
7. For "To value," type in the "Total Paste Volume" of the middle sack mix
8. For "By changing cell", select the blue "Cement/Mass" cell. Click "OK" to see new Cement and Mixing water data.
Click "OK" button again to accept and save the new values.
9. Repeat steps 5 through 8 for the low w/c ratio mix.
10. Trial batches with identical aggregate & paste volumes provide valid strength vs. w/c ratio data.
(Note: To maintain consistent slump gradually increase dosage of water-reducing admixture while moving to higher cement contents, as the paste gets thicker. Constant slump is desirable for establishing air-entraining agent dosage. Air-entrainment agents are more effective at higher slumps.)

	Mass (lb)	Vol. (ft ³)
w/c ratio	0.500	
Total free water	282	
Cement, Cell B25>	564	2.87
Silica Fume		
Mixing water	282	4.52

Cement:
94 lbs / sack
6.0 sack = 564.0 lbs
Total Cementitious = 564.0 lbs
Total Paste Volume (ft³) = 7.389 ← Steps 5-8, with cursor on this cell use Goal Seek to change Cement mass in Cell B25 until paste volume = 7.515

	Mass (lb)	Vol. (ft ³)
w/c ratio	0.450	
Total free water	275	
Cement	611	3.11
Silica Fume		
Mixing water	275	4.41

Cement:
94 lbs / sack
6.5 sack = 611.0 lbs
Total Cementitious = 611.0 lbs
Total Paste Volume (ft³) = 7.515 ← Step 4 is Goal for all three w/c ratios

	Mass (lb)	Vol. (ft ³)
w/c ratio	0.400	
Total free water	263	
Cement, Cell B39>	658	3.35
Silica Fume		
Mixing water	263	4.22

Cement:
94 lbs / sack
7.0 sack = 658.0 lbs
Total Cementitious = 658.0 lbs
Total Paste Volume (ft³) = 7.566 ← Step 9, with cursor on this cell use Goal Seek to change Cement mass in Cell B39 until paste volume = 7.515

Reference Data:

Type I cement, Sp G:	3.15
Silica Fume, Sp G:	2.2
Water, unit weight at 20 ^o C (pcf):	62.4

6. Mix Design Volumetric Data - 6.0 sk Trial 1

Mix Design Volumetric Data - 6.0 sk Trial (1)

Note: Blue Font = Data Entry, Red Font = Calculation

Type of Concrete: 5000 psi
 Project Name: Slabs - Not exposed to Freeze/Thaw

Date: _____
 Calculated by: _____
 Checked by: _____

Mix Design Criteria:

Maximum Nominal Aggregate Size (inches):	3/4
Cement (Minimum weight per cubic yard):	520 lbs
Cement Mfg / Type:	Type I/II
Max Water/Cementitious Materials Ratio (lbs/lb):	0.46
28 day Design Strength, (f _c):	5000 psi
28 day Required Strength, (f _{cr}):	6200 psi
Slump Range (inches):	4 ± 1.5"
Entrained Air Content (% by Volume):	1.5 ± 1%
Mix Ratio by weight (Cementitious:Sand:Gravel)	1:2.47:3.07
Sand Content (% by Weight of SSD Agg):	44.6%

FA, CA Mix Ratios
 2.47
 3.07

Aggregate Moisture (As Received):

	CA	FA
Tare	1012.1	1238.8
T + Wet	2498.4	2534.0
T + Dry	2470.0	2471.3
Water	28.4	62.7
Dry	1457.9	1232.5
%M	1.95%	5.09%

Reference Data:

Type I cement, Sp G:	3.15
Water, unit weight at 20° C (pcf):	62.4

Aggregate Characteristics:

Moisture	Size	AASHTO	Bulk Sp G	SSD Sp G	App Sp G	Absorption	Free water
1.95%	Coarse Agg	M-43 #67	2.638	2.674	2.738	1.38%	0.57%
5.09%	Fine Agg	M-6	2.643	2.675	2.732	1.23%	3.86%

Units: 1 gallon = 128 fl oz = 3785.3 milliliter 1 pound = 453.59 grams
 1 fl oz = 29.57 ml

Admixtures:	Enter Dose fl oz/100#	Trial Batch Amounts			Cubic Yard Amounts		Admixture SpG
		fl oz	ml	lbs	fl oz / yd ³	lbs / yd ³	
Polyheed 997	5.00	1.594	47.1	0.132	28.7	2.376	1.27
Micro-Air	0.00	0.000	0.0	0.0000	0.0	0.000	1.01
	0.00	0.000	0.0	0.000	0.0	0.000	1

Dry Batch weights for 1.0 yd ³	Weight (lbs.)	Volume (ft ³)	SSD Batch Weights (lbs.)	Field Mois Batch Wts (lbs.)	Aggregate Free Water (lbs.)
w/c ratio	0.500				
Total free water	287				
Cement	574	2.92	574	574	
Mixing water	287	4.60	287	223	
Coarse Aggregate (Dry)	1738	10.56	1762	1772	10
Polyheed 997 Admixture	2.376	0.03	2.4	2.4	
Micro-Air Admixture	0.000	0.00	0.0	0.0	
Air 1.5%	0.000	0.00	0.0	0.0	
Volume Subtotal =		18.51			
Fine Aggregate (Dry)	1400	8.49	1417	1471	54
Totals	4001	27.00	4042	4042	64
Unit Weight (pcf)	148.2		149.7	149.7	

Cement:

94 lbs / sack
 6 sack = 564.0 lbs
 Total Cementitious = 574.0 lbs

Paste Volume (ft³) = 7.520

Extra Water Record:

Tare _____
 Start T+W _____
 End T+W _____
 Water added _____

6. Mix Design Volumetric Data - 6.0 sk Trial 1

Mix Design Volumetric Data - 6.0 sk Trial (1) - Continued

Trial Batch Volumetrics Size (ft ³)	1.5	Weight (lbs.)	Volume (ft ³)
Cement		31.889	0.162
		0.000	
Mixing water		12.392	0.199
Dry Coarse Aggregate		96.556	0.587
CA Absorption		1.332	
CA Free Water		0.550	0.009
Total Weight Wet CA =		98.438	
Polyheed 997 Admixture		0.132	0.002
Micro-Air Admixture		0.000	0.000
		0.000	0.000
Air 1.5%		0.00	0.023
Dry Fine Aggregate		77.763	0.472
FA Absorption		0.956	
FA Free Water		3.002	0.048
Total Weight Wet FA =		81.721	
Totals		224.573	1.500
Calculated Unit Wt w/Admixtures			149.7 pcf

Added water (lbs)
 Total Mixing Water in Trial batch 16.944
 Final W/C Ratio 0.500

Use Table below to check Trial Batch % Air Reading.
 Use Goal Seek to change the blue % Air number until Unit Weight matches value recorded in "Trial Batch Data" at page bottom.

1. Select red unit weight cell near bottom of table.
2. Select "Data" tab, then "What if?", then "Goal Seek".
3. Set the red Unit Weight cell "To value" in Trial Batch Data
4. "By changing" blue % Air cell. Click OK to solve & to save.

Item	Volume (ft ³)
Cement	2.920
Water	4.599
Coarse Ag	10.558
Poly 997	0.030
Micro-Air	0.000
Pozzutec2	0.000
Fine Agg	8.487
Air was calculated from Unit Weight of	149.7
Total Vol.	27.000

Theoretical Maximum Unit Wt at 0.0% Air (pcf) = 152.0

For Sizing Trial Batch: Enter % Air here or calculate with Goal Seek →

- Note: 6x12 cyl = 0.196 ft³
- 4x8 cyl = 0.058 ft³
- Slump cone = 0.204 ft³
- Unit wt bucket = 0.25 ft³
- 16 ea 4x8 cyl = 0.93 ft³
- Min Trial batch = 1.38 ft³

1. Select this cell, then open "Goal Seek" →

Trial Batch Data:

Temperature	48	°F	Weight of Tare	7.920	lbs
Slump	5.5	inches	Wt of Tare & Concrete	44.725	lbs
Air	2.0%		Weight of Concrete	36.805	lbs
Unit Weight	147.2	pcf	Volume of Tare	0.2500	ft ³
Yield (ft ³ /sk)	4.497		Weight of all ingredients as batched	224.573	lbs

(ASTM C138, Sec 7.6, Equation (7))

To calculate % Air from Unit Weight:

$$A = [(T - D)/T] \times 100$$

Where: A = % Air

D = Wet Unit Weight

T = Theoretical Maximum Unit Weight = 152.0

Calculate % Air (x) from Unit Weight (y)		
For D =	147.2	pcf
A =	3.2	% Air

or

To calculate Unit Weight from % Air:

Solve: A = [(T - D)/T] x 100 for D

$$A/100 = (T - D)/T$$

$$AT/100 = T - D$$

$$D = T - AT/100$$

Calculate Unit Weight (y) from % Air (x)		
For A =	7.6	% Air
D =	140.4	pcf

7. Mix Design Compressive Strength & Unit Weight Data - 6.0 sk Trial 1

Mix Design Compressive Strength & Unit Weight Data - 6sk Trial 1, No Air, $f'_c = 5000$ psi

Note: Blue Font = Data Entry, Red Font = Calculation 1.00 psi = 6.894761 kPa

Date & Age Data			Cylinder Compressive Strength Data					Compressive Strength	
Cast	Tested	Age (Days)	Cyl ID	Diameter 1 (Inches)	Diameter 2 (Inches)	XC Area (Sq Inch)	Peak Load (Pounds)	f'_c (psi)	f'_c (kPa)
5/3/2013	5/6/2013	3	181	4.00	4.00	12.57	34,085	2710	18700
5/3/2013	5/6/2013	3	182	4.00	4.01	12.60	34,040	2700	18600
5/3/2013	5/6/2013	3	183	3.99	4.00	12.53	34,020	2710	18700
5/3/2013	5/6/2013	3	184	4.00	3.99	12.53	33,765	2690	18500
5/3/2013	5/10/2013	7	185	4.000	4.000	12.57	58,015	4620	31900
5/3/2013	5/10/2013	7	186	4.020	3.990	12.60	58,565	4650	32100
5/3/2013	5/10/2013	7	187	4.020	4.010	12.66	57,115	4510	31100
5/3/2013	5/10/2013	7	188	4.020	4.010	12.66	58,175	4590	31600
5/3/2013	5/17/2013	14	189	4.000	4.010	12.60	71,855	5700	39300
5/3/2013	5/17/2013	14	190	3.990	4.010	12.57	71,350	5680	39200
5/3/2013	5/17/2013	14	191	3.990	4.000	12.53	69,875	5570	38400
5/3/2013	5/17/2013	14	192	4.010	4.000	12.60	70,755	5620	38700
5/3/2013	5/31/2013	28	193	3.990	4.000	12.53	78,255	6240	43000
5/3/2013	5/31/2013	28	194	4.000	3.980	12.50	75,930	6070	41900
5/3/2013	5/31/2013	28	195	3.980	3.980	12.44	76,835	6180	42600
5/3/2013	5/31/2013	28	196	3.980	3.980	12.44	75,110	6040	41600

Average 3 day f'_c = 2700

Average 7 day f'_c = 4590

Average 14 day f'_c = 5640

Average 28 day f'_c = **6130**

Note: Use cylinder unit weight to check wet unit weight and mix design value. Find root cause if $D > 1.85$ pcf

Cylinder Unit Weight Data							Unit Weight	
Cyl ID Number	Wt in Air (grams)	Wt in H ₂ O (grams)	H ₂ O Temp (°C)	H ₂ O Density (g/cm ³)	Cyl Volume (cm ³)	Cyl Density (g/cm ³)	(lbs/ft ³)	(kg/m ³)
181	3944.5	2298.1	22.8	0.99759	1640.8	2.4039	150.0	2404
182	3960.2	2315.3	22.8	0.99759	1639.3	2.4158	150.7	2416
183	3926.3	2285.1	22.8	0.99759	1635.7	2.4004	149.8	2400
184	3938.1	2295.2	22.8	0.99759	1637.4	2.4052	150.1	2405
185	3948.9	2304.1	23.9	0.99732	1638.6	2.4099	150.4	2410
186	3973.4	2328.2	23.9	0.99732	1638.9	2.4244	151.3	2424
187	3975.1	2325.2	23.9	0.99732	1643.7	2.4185	150.9	2418
188	3949.9	2305.6	23.9	0.99732	1638.1	2.4113	150.5	2411
189	3981.8	2338.5	20.6	0.99808	1638.8	2.4297	151.6	2430
190	3971.2	2320.1	20.6	0.99808	1646.6	2.4117	150.5	2412
191	3990.2	2349.6	20.6	0.99808	1636.1	2.4389	152.2	2439
192	3989.5	2348.3	20.6	0.99808	1636.7	2.4376	152.1	2438
193	3970.1	2322.7	20.5	0.99810	1643.0	2.4164	150.8	2416
194	3956.0	2312.4	20.5	0.99810	1639.2	2.4134	150.6	2413
195	3967.5	2322.8	20.5	0.99810	1640.3	2.4188	150.9	2419
196	3977.4	2332.9	20.5	0.99810	1640.1	2.4252	151.3	2425

Average Unit Weight = **150.9**

5000 psi NO AIR Concrete Mix Design

NO AIR Compressive Strength vs. Water / Cement Ratio - 3 trial batches

▲ 28 Day psi vs. w/c Ratio

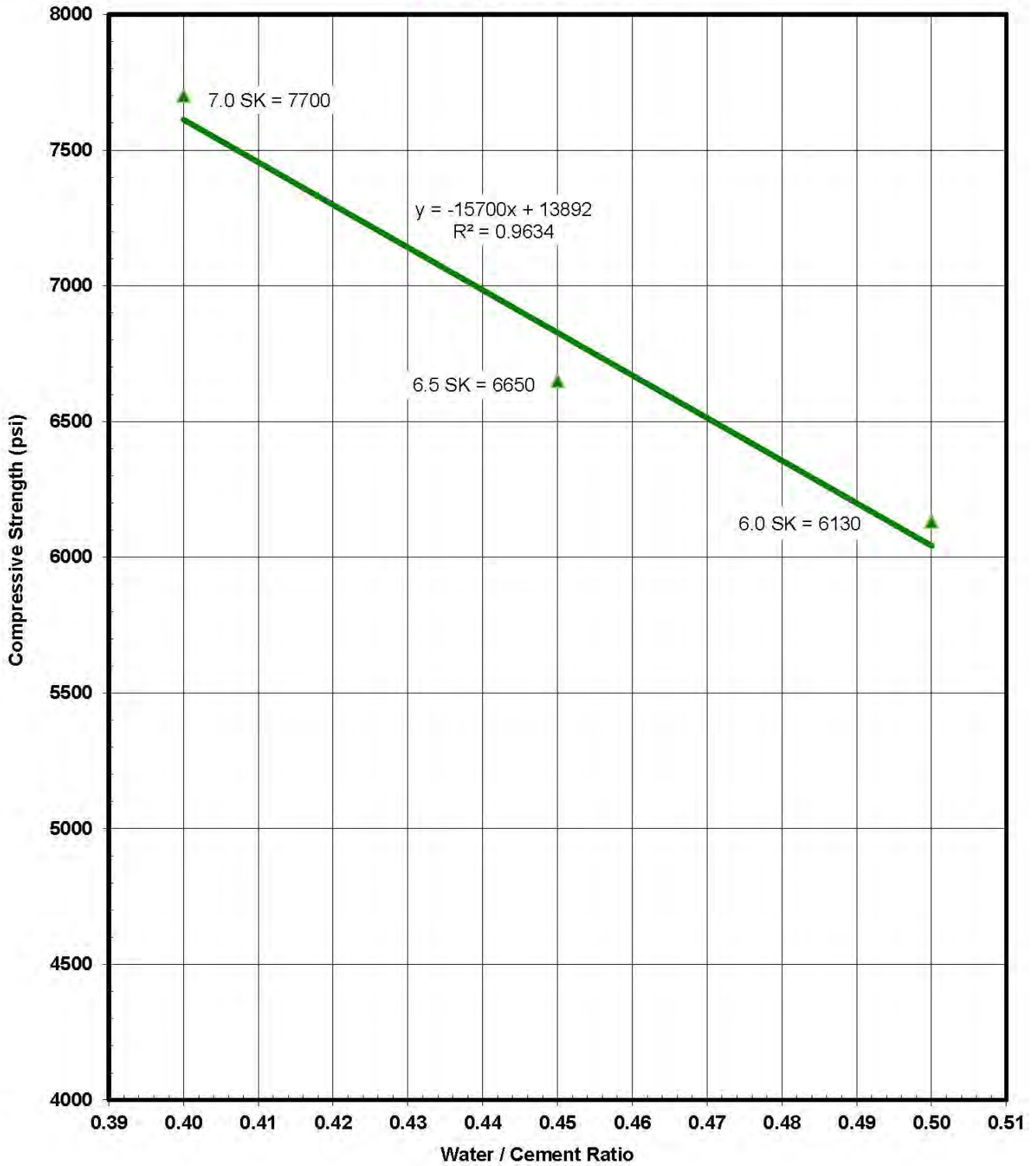

5000 psi NO AIR Concrete Mix Design

Compressive Strength vs. Water / Cement Ratio w/Line at $f'_{cr} = 6200$ psi

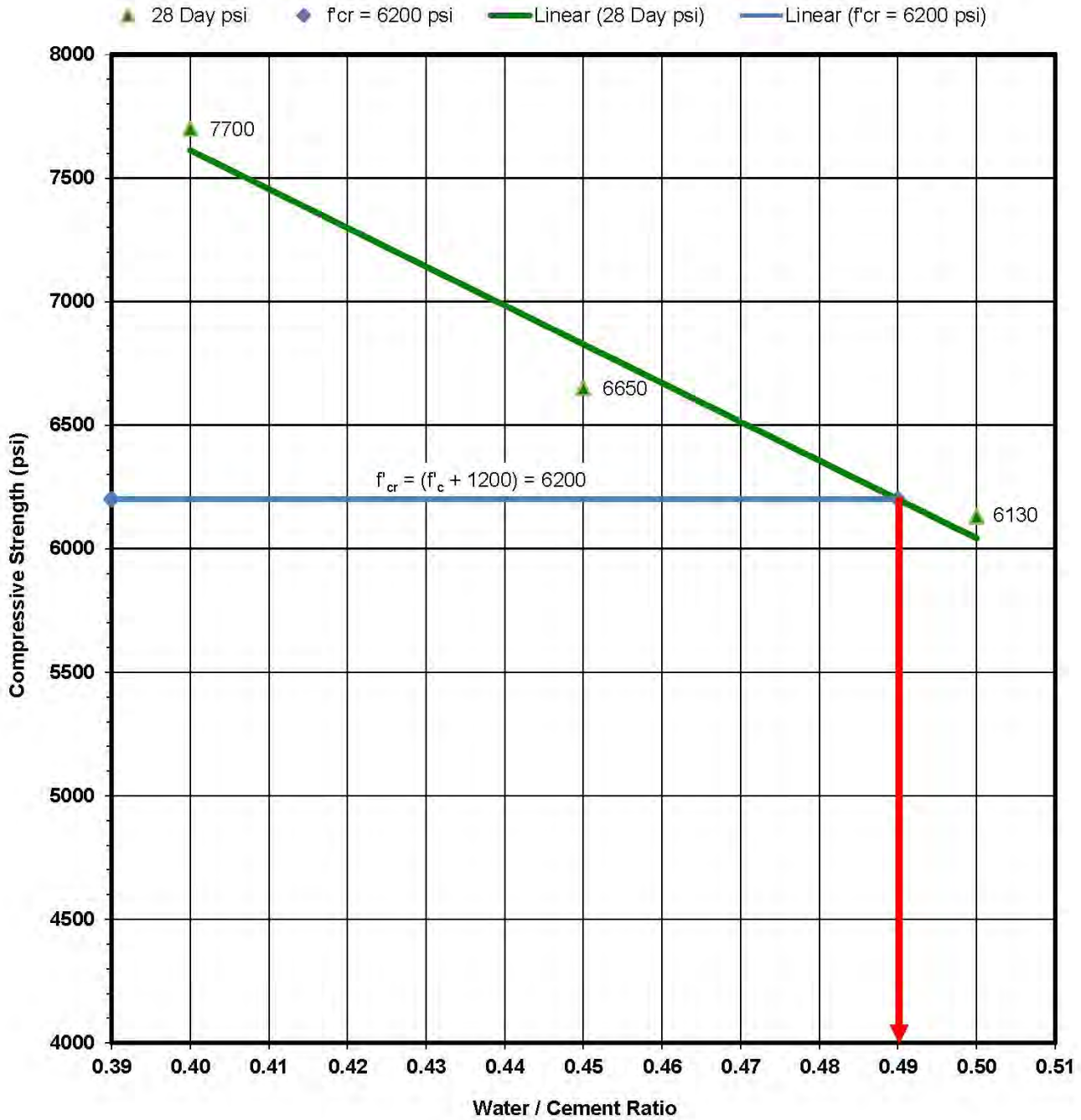

For 5000 psi No Air concrete final proportions: Maximum w/c = 0.49

4000 psi, 5% Air Concrete Mix Design

28 Day Compressive Strength vs % Air for 3 batches at w/c = 0.400

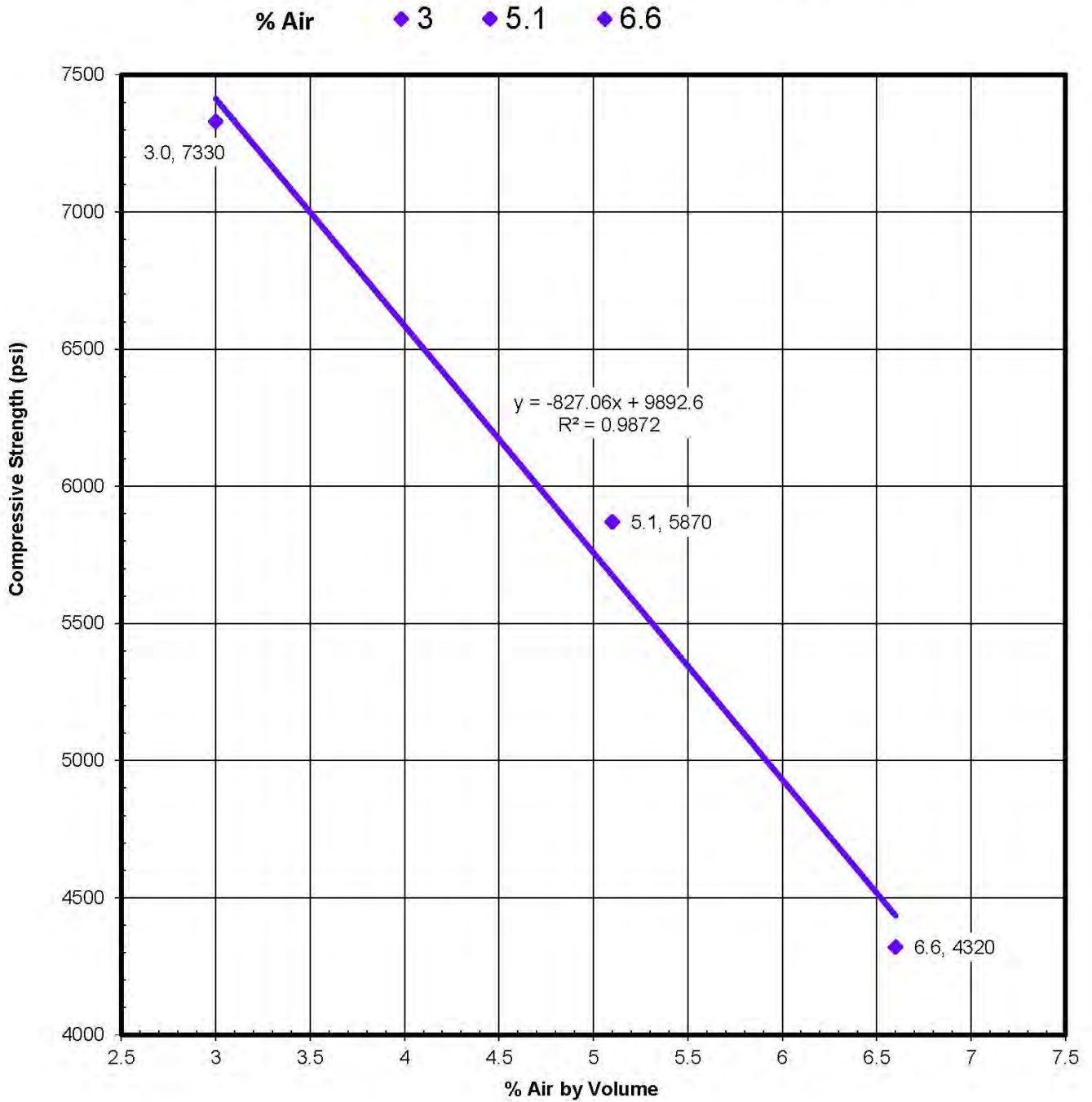

4000 psi, 5% Air Concrete Mix Design

28 Day Compressive Strength = 5760 psi at 5.0% Air, 0.40 w/c

- ◆ Strength (psi) vs. % Air
- Strength at 5% Air
- Linear (Strength (psi) vs. % Air)
- ← Linear (Strength at 5% Air)

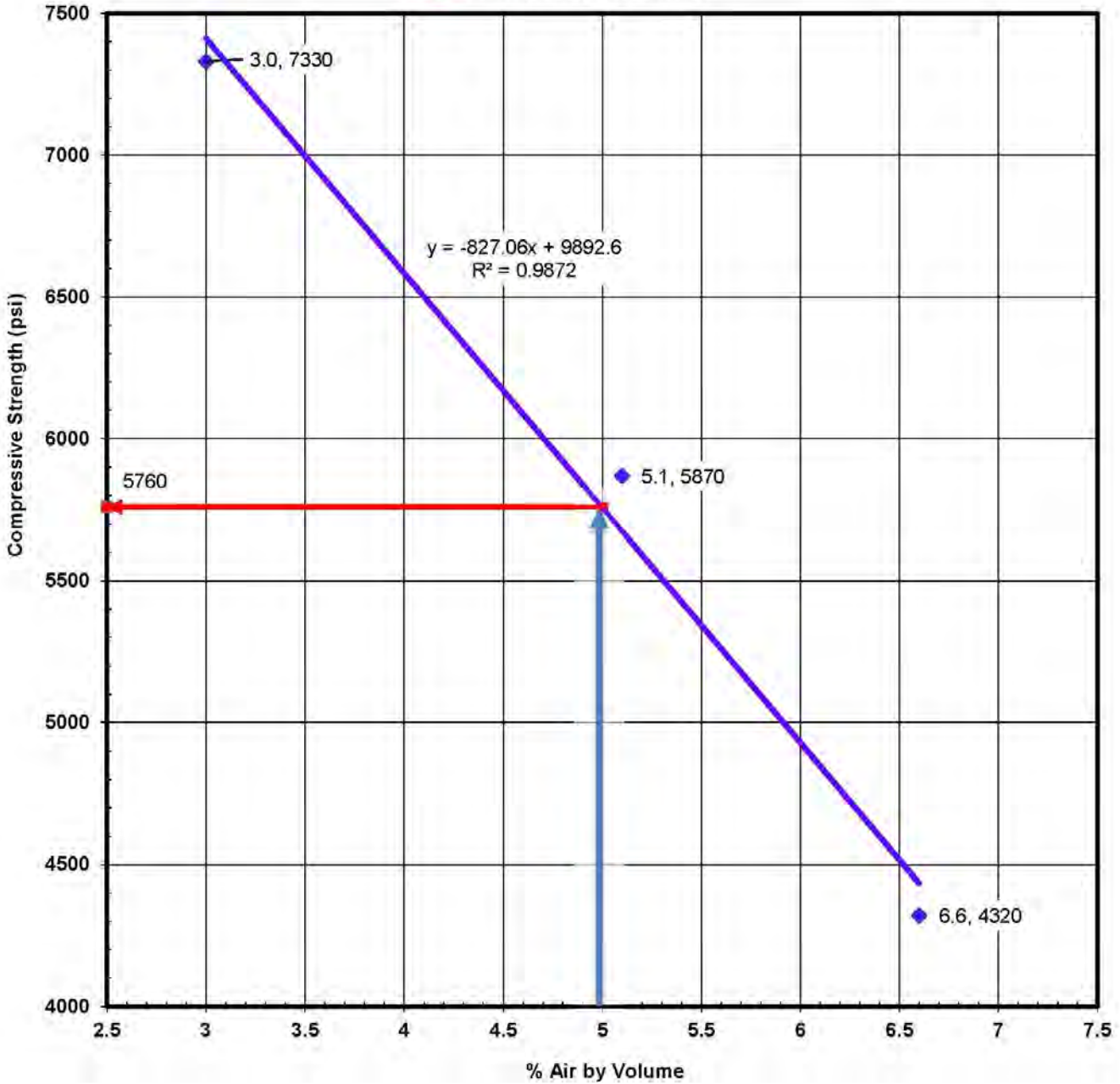

4000 psi, 5% Air Concrete Mix Design

5760 psi point at 0.40 w/c, 5% Air, Plotted w/ NO AIR Strength vs. w/c line

▲ 28 Day psi - NO Air vs. w/c ◆ 5% Air Strength at w/c = 0.40

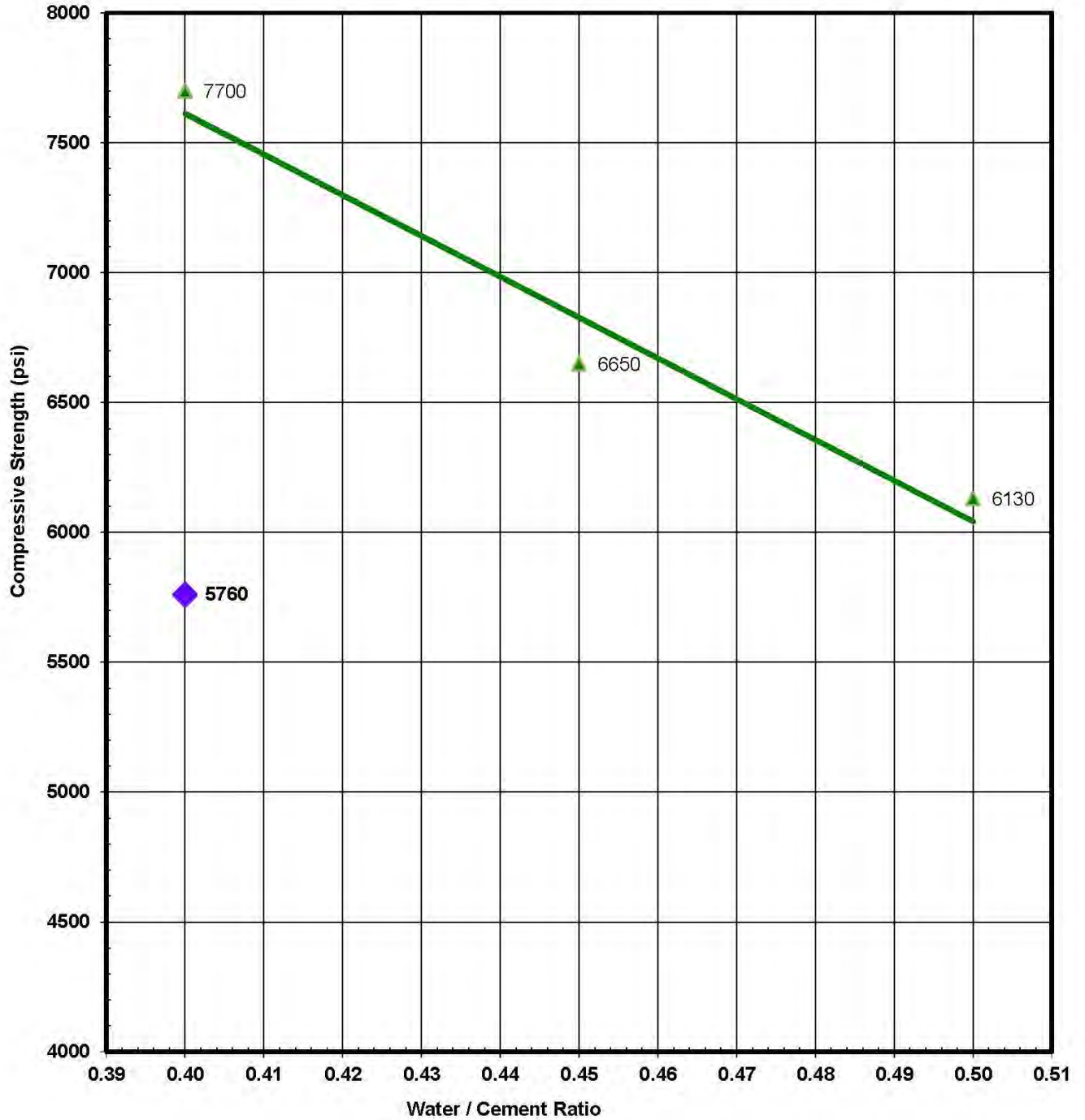

4000 psi, 5% Air Concrete Mix Design

Line thru 5760 psi, 0.40 w/c, Air-Entrained point parallel to NO AIR line

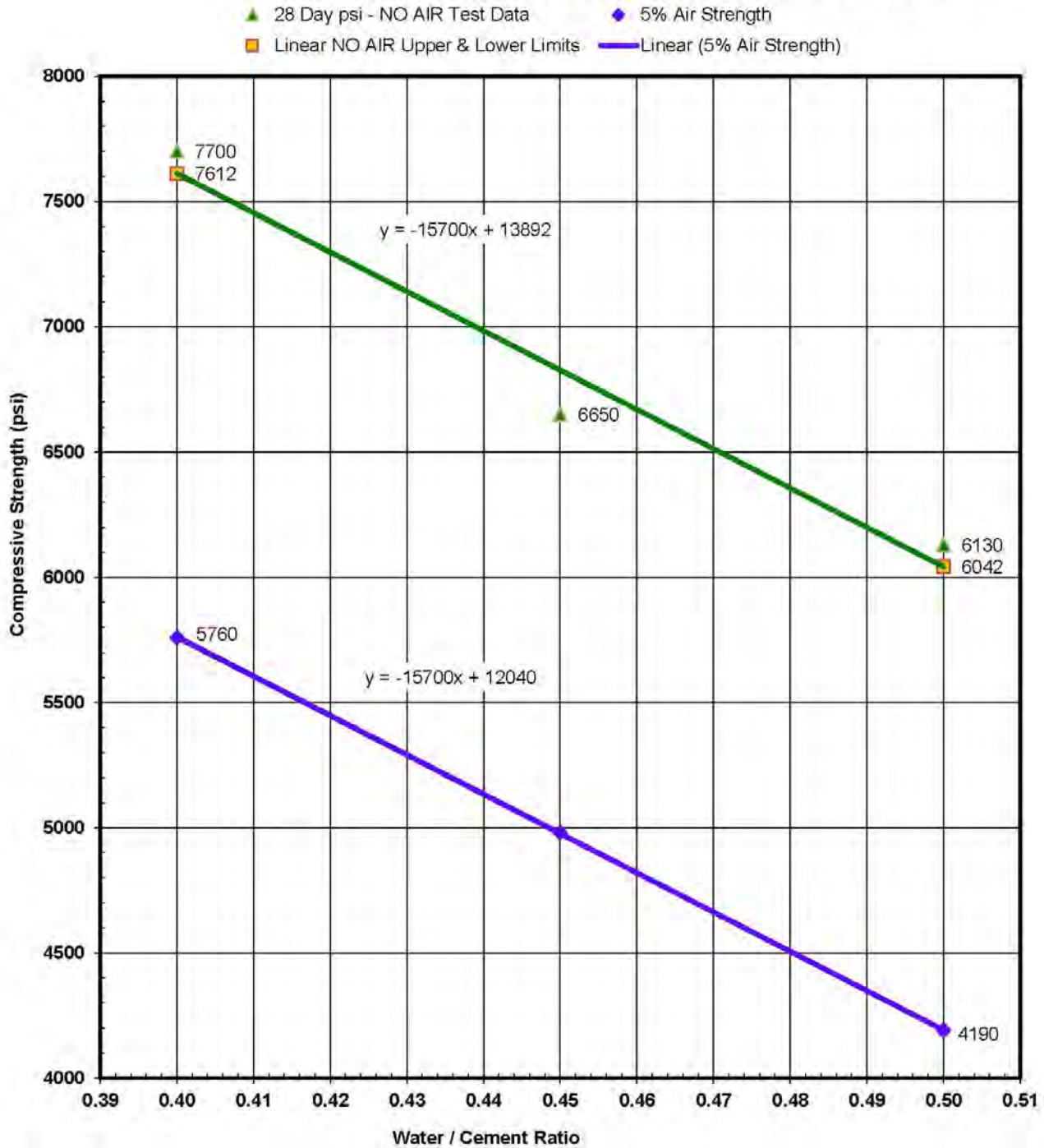

4000 psi, 5% Air Concrete Mix Design

5200 psi f_{cr} line crosses 5% Air Strength vs. w/c line at Max w/c Ratio

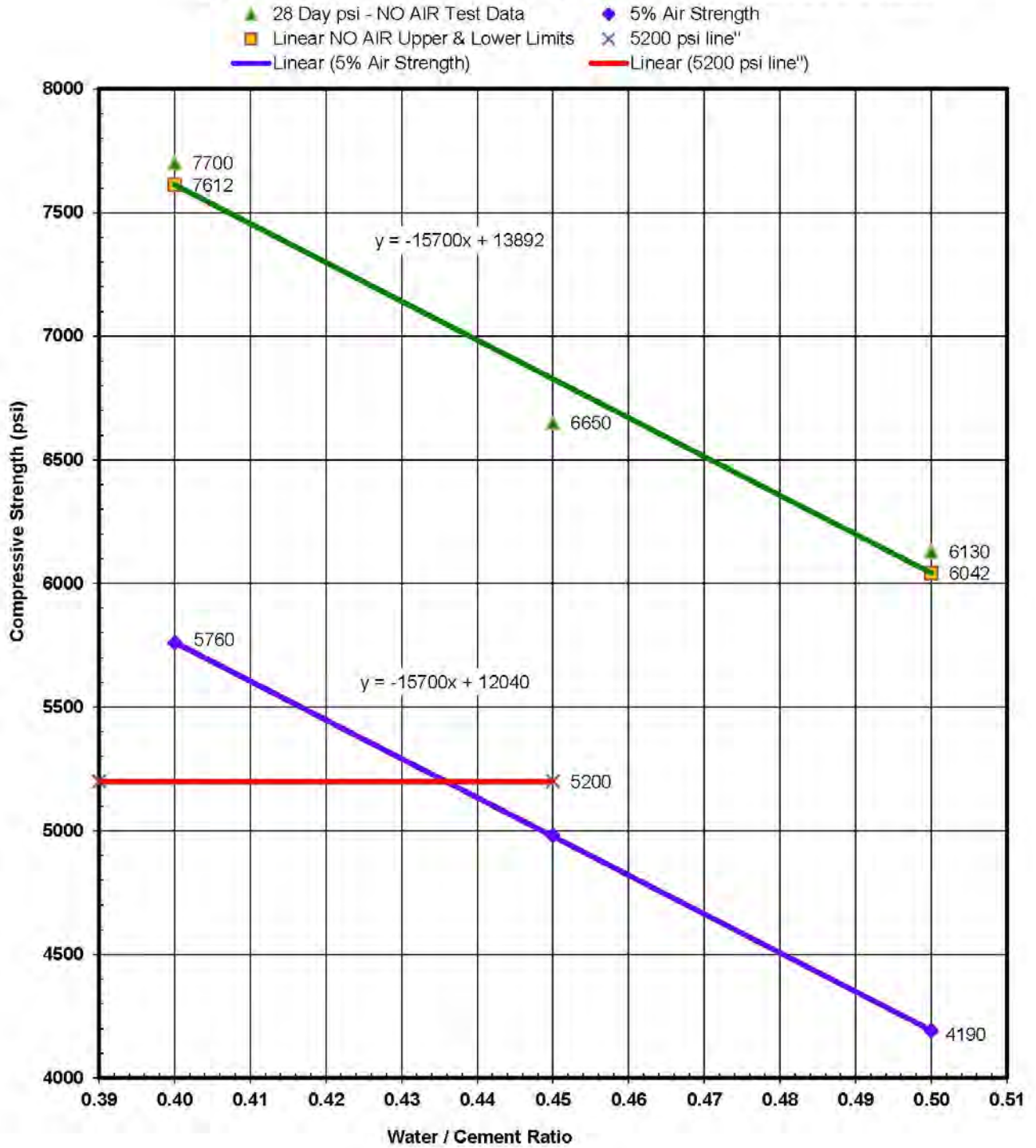

4000 psi, 5% Air Concrete Mix Design

Max w/c = 0.435 for $f'_{cr} = 5200$ psi with 5% Air

- ▲ 28 Day psi - NO AIR Test Data
- ◆ 5% Air Strength
- Linear NO AIR Upper & Lower Limits
- × 5200 psi line

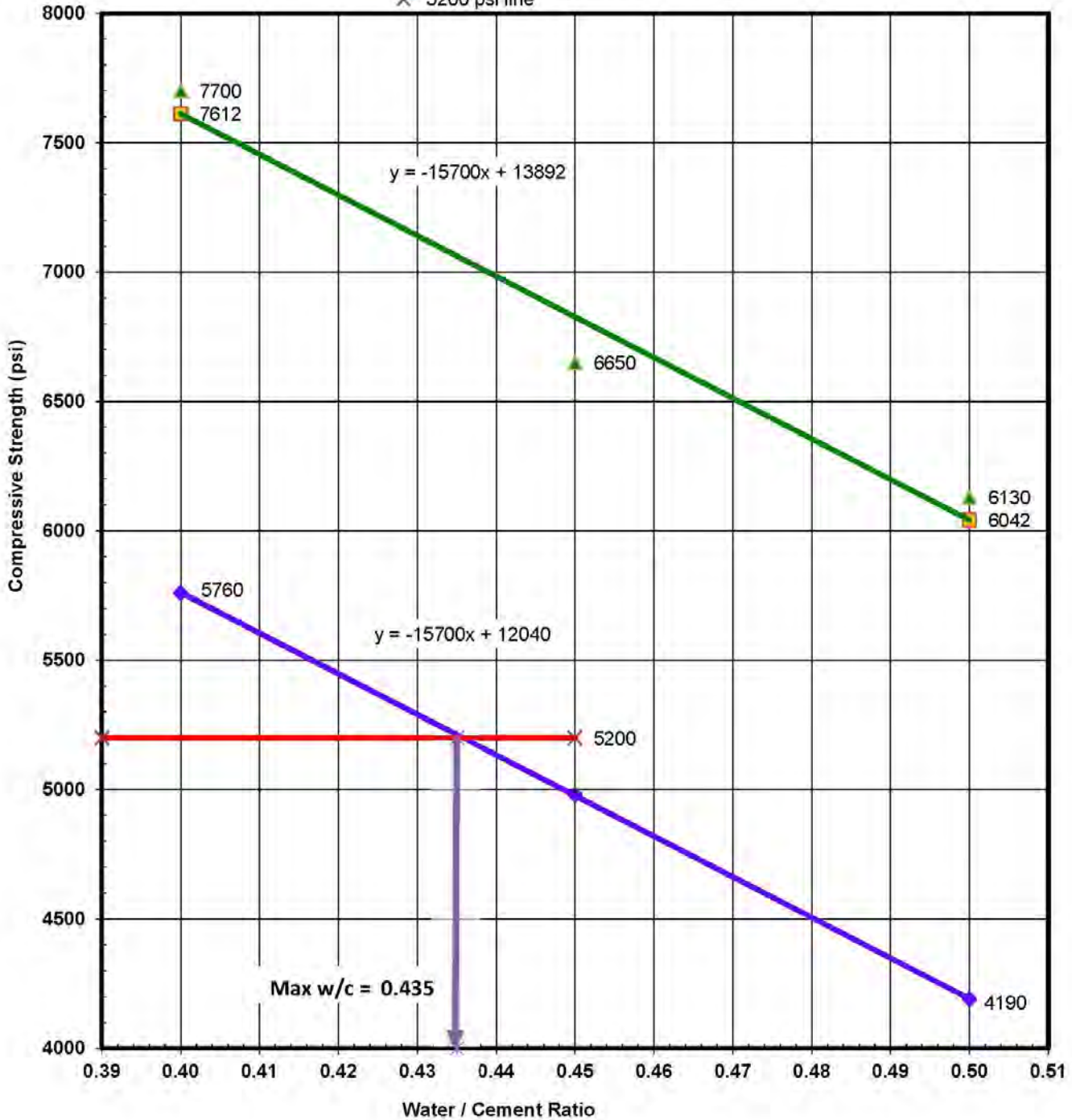

5000 psi, NO AIR Concrete Mix Design

NO AIR Strength vs. Age - 3 Cement Contents

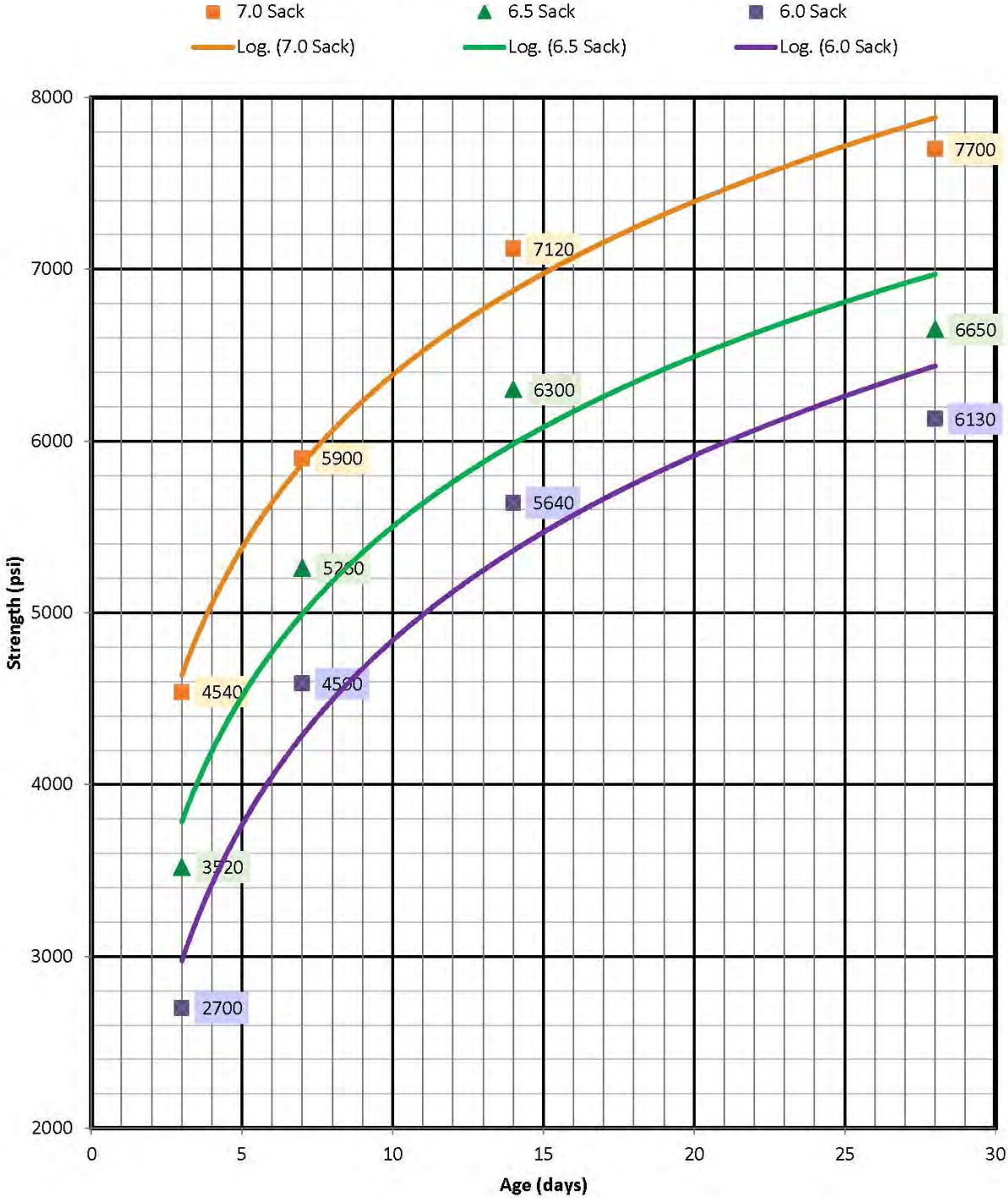

4000 psi, 5% Air Concrete Mix Design

5% Air Strength vs. Age - 4 Cement Contents

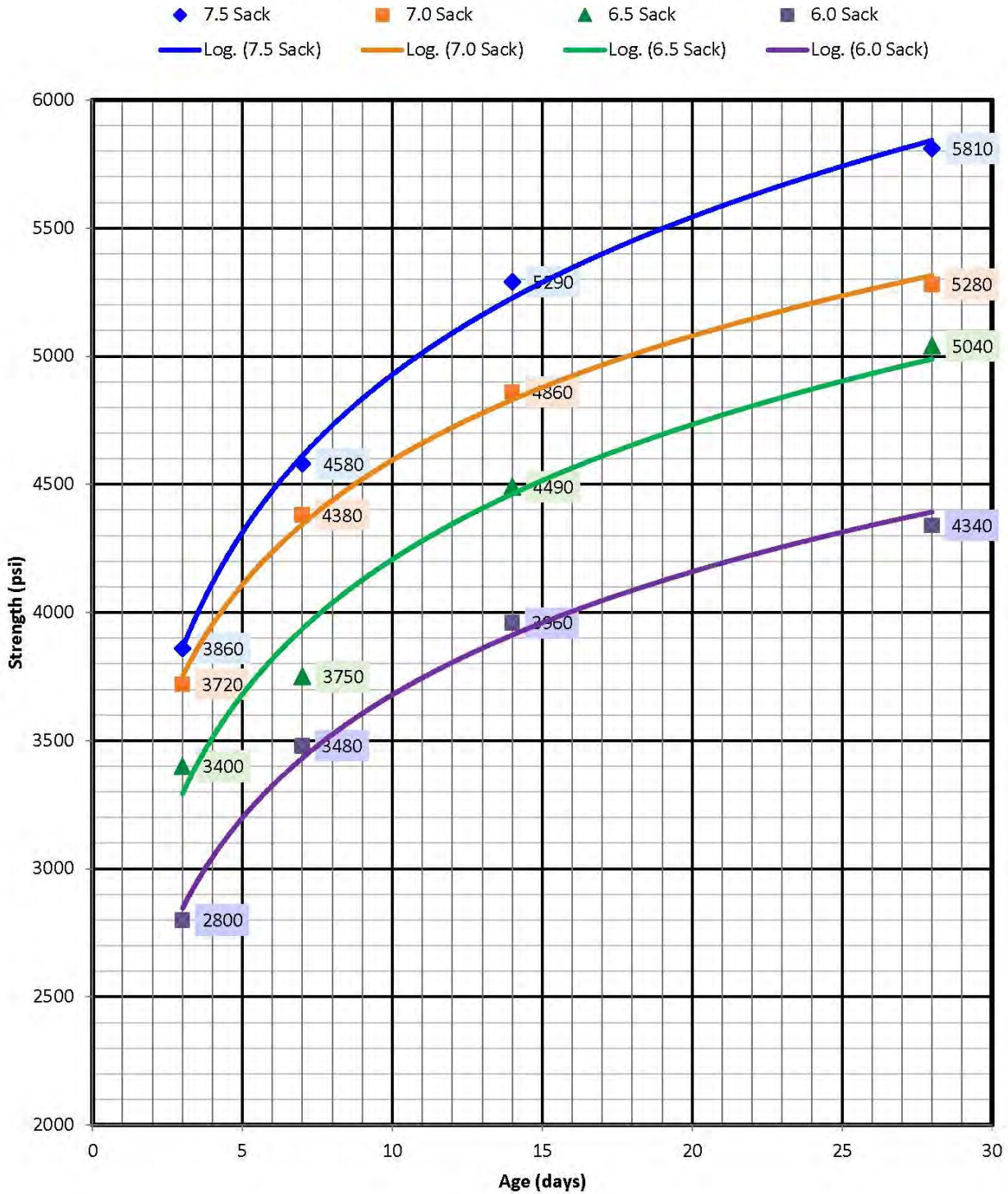

Mix Design Unit Weight vs. % Air

(ASTM C138, Sec 7.6, Equation (7))

To calculate % Air from Unit Weight:

$$A = [(T - D)/T] \times 100$$

Where: A = % Air

D = Wet Unit Weight

T = Theoretical Maximum Unit Weight (pcf) =

To calculate Theoretical Max. Unit Weight (T) from Mix Design
Divide Gross Wt by Non-Air Volume:

Gross Wt. (lb.)	Non-Air Volume (cu. ft.)	T, No Air (pcf)
3889.0	25.58	152.0
		152.0

To calculate Unit Weight from % Air:

Solve for D: $A = [(T - D)/T] \times 100$

$$A/100 = (T - D)/T$$

$$AT/100 = T - D$$

$$D = T - AT/100$$

Data for graphing Unit Weight vs. % Air

A	D	D - 2s	D + 2s
Air %	Unit Wt. (pcf)	Unit Wt.	Unit Wt.
10	136.8	134.5	139.1
9	138.3	136.0	140.6
8	139.8	137.5	142.2
7	141.4	139.1	143.7
6	142.9	140.6	145.2
5	144.4	142.1	146.7
4	145.9	143.6	148.2
3	147.4	145.1	149.8
2	149.0	146.7	151.3
1	150.5	148.2	152.8
0	152.0	149.7	154.3

ASTM C138 Unit Weight Precision (pcf):		
	1s	2s
Single Operator	0.65	1.85
Multi-Operator	0.82	2.31

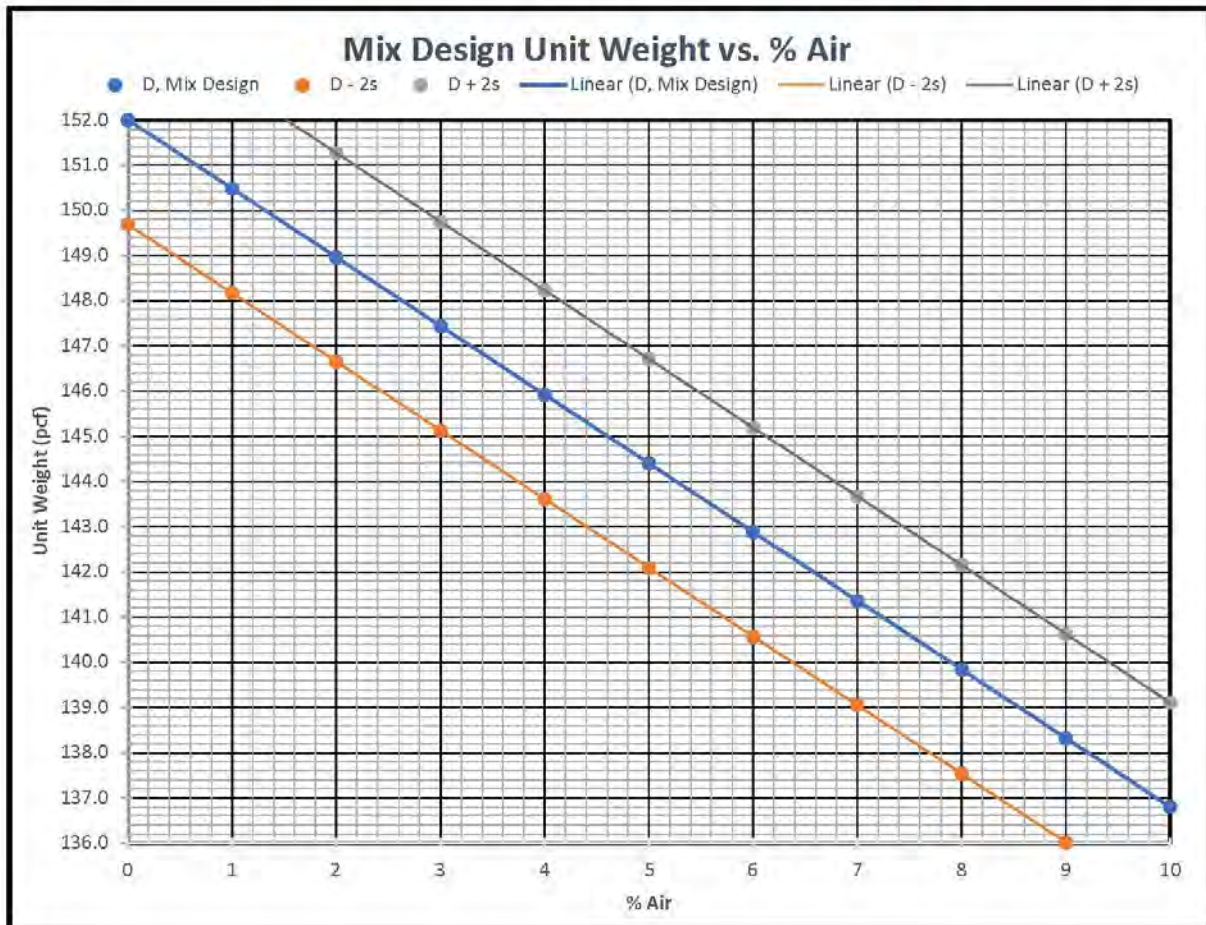

Air-Entrained Concrete Strength vs. Gravimetric % Air

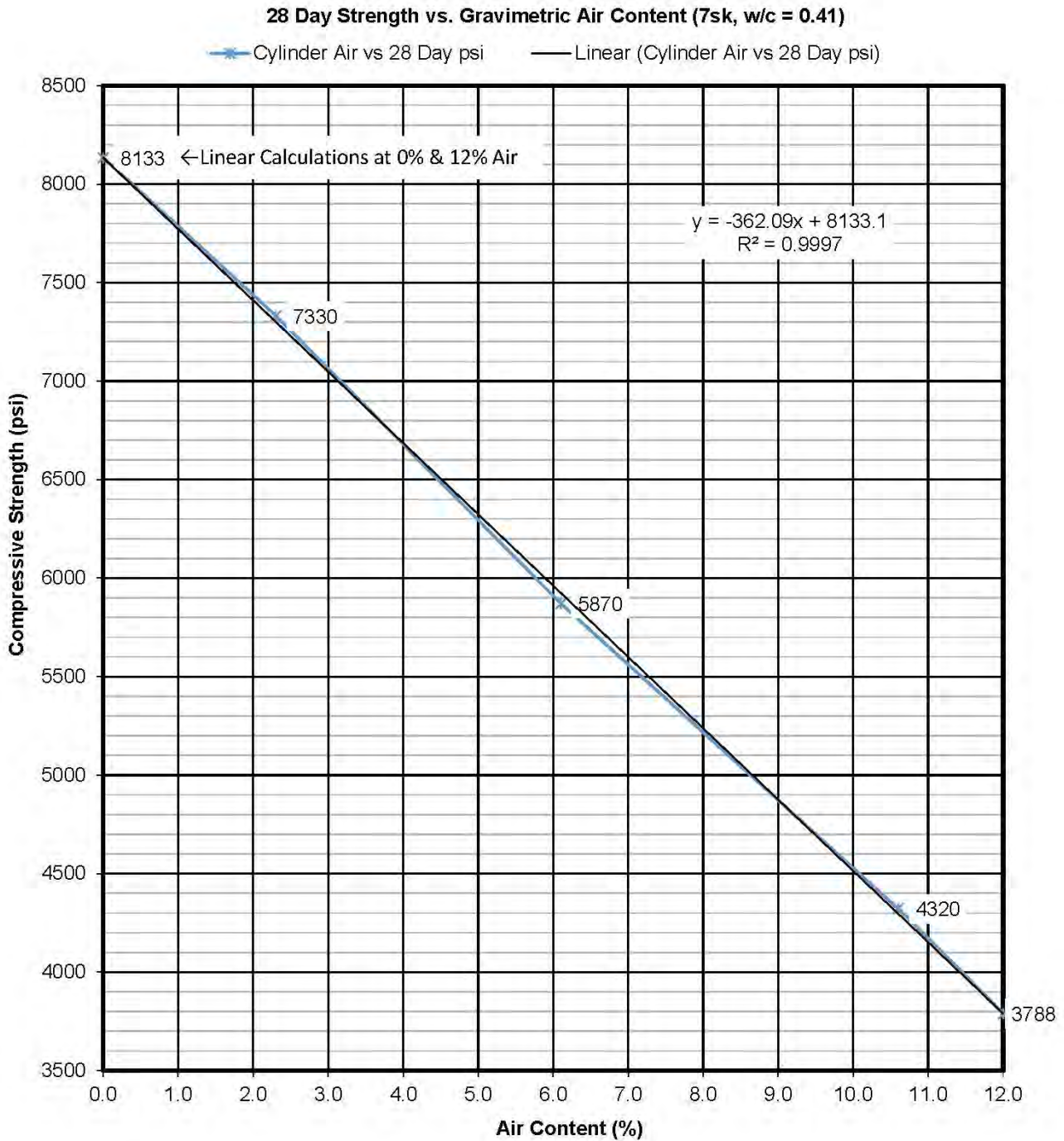

ATM 601 Welded Lock Seam Strength of Corrugated Metal Pipe

TENSILE STRENGTH TEST FOR WELDED LOCK SEAMS ON GALVANIZED STEEL CORRUGATED METAL PIPE (CMP) (AN ABBREVIATION OF AASHTO T 241 HELICAL CONTINUOUSLY WELDED SEAM CORRUGATED STEEL PIPE)

1. Scope

This procedure provides instructions for determining the tensile strength of welded lock seams on galvanized steel corrugated steel pipe in accordance with AASHTO T 241.

2. Apparatus

- Tensile testing frame with minimum load capacity of 3000 pounds, resolution of 1 pound and with clamping or gripping devices capable of holding test coupon ends without slippage during the test.
- Calipers capable of measuring gauge section width and single sheet metal thickness to 0.0005 inches.
- A press, vice or similar device to flatten the corrugated test specimens prior to test coupon preparation.
- Metal saw or other metal cutting device and grinders, files, or other metal working tools for preparation of test coupons.

3. Procedure

1. Three each, 2-4" wide x 6-8" long, test specimens shall be cut perpendicular across the welds from a randomly selected production section of CMP, such that each specimen contains 2-4" of welded lock seam.
2. Prepare a sequentially numbered test coupon from each test specimen.

A suggested Coupon ID system is: Ga-w-#, where:

Ga = Galvanized steel sheet metal gauge

w = Nominal test coupon gauge section width (in)

= Test coupon number

3. Three test coupons pulled to failure shall constitute a tensile strength test.
4. Prepare test coupons to conform to Figure 1 and the following dimensions:

Nominal Thickness	Galvanized Steel Sheet Gauge	Coupon dimensions		Gauge section	
		End Width	Length	Width	Length
0.0635"	16 Gauge	3" Max.	6-8"	0.80±.05"	2"
0.0785"	14 Gauge	3" Max.	6-8"	0.65±.05"	2"
0.1084"	12 Gauge	3" Max.	6-8"	0.50±.05"	2"
0.1382"	10 Gauge	3" Max.	6-8"	0.40±.05"	2"
0.1681"	8 Gauge	3" Max.	6-8"	0.30±.05"	2"

Radius from gauge section to coupon ends shall be 1". See Figure 1 for other dimensions.

5. Measure to nearest 0.0005" and record single layer metal thickness of test coupon in the gauge section adjacent to the welded lock seam.

6. Measure to nearest 0.0005" and record the width of the test coupon in the gauge section at the welded lock seam.
7. Multiply thickness by width to calculate the cross sectional area of the gauge section adjacent to the welded lock seam.
8. Clamp test specimen into test frame and load specimens at a constant rate of $0.20 \pm 10\%$ inches per minute.
9. Test to failure and record peak test load to the nearest pound. (If specimen reaches load frame capacity without failure, record peak load applied and note that specimen did not break.)
10. Calculate tensile strength by dividing test load by cross sectional area.
11. Calculate average tensile strength of coupons in the test set (minimum of 3).
12. Discard the tested coupons.

4. Report

- Results on forms approved or provided by the Department.

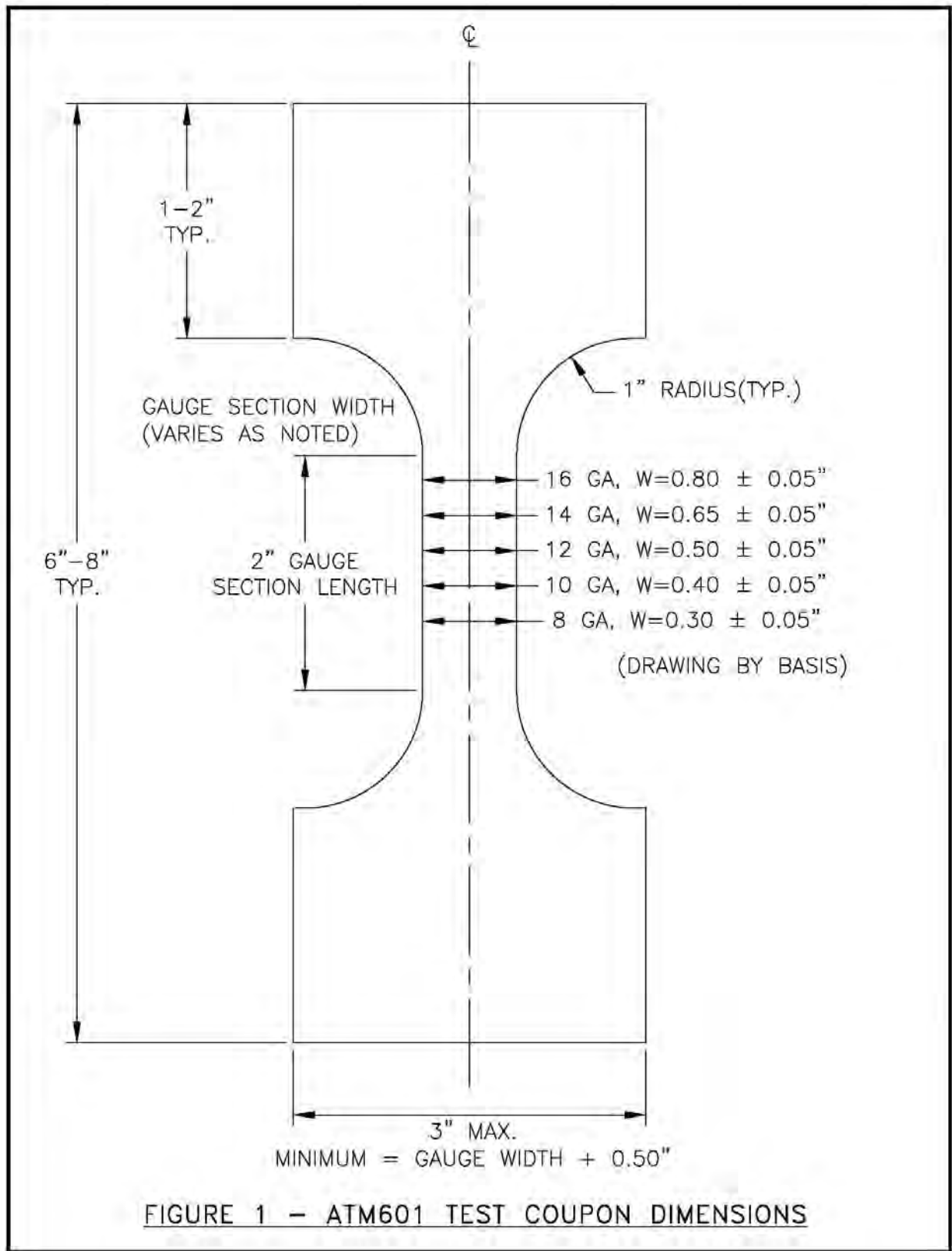

Figure 1
Test Coupon Dimensions

Welded Lock Seam Tensile Testing of Corrugated Metal Pipe (CMP)									
Welded Seam CMP testing done by:									
Test date:									
Test apparatus information:									
Apparatus name/Mfg:									
Model Number:									
Max. load capacity (lb):					Load resolution (lb):				
Loading rate (in/min):					Loading mechanism:				
Digital or Analog display:					Load Cell Mfg./Model:				
Calibration Date:					Calibrated by:				
Material: Galvanized Steel Corrugated Metal Pipe									
Reference: AASHTO T 241, AASHTO M 218									
Minimum required base metal tensile strength (psi) = 45,000 90% of base metal strength req'd = 40,500									
Coupon ID	Gauge	Nominal Ga	Measured	Width	Area	Required Min	Test Load	Test Stress	Pass/Fail
Ga-w-# ¹	(US Sheet)	Thickness (in)	Thickness (in)	(in)	(in ²)	Load (lb)	(lb)	(psi)	
							Average:		

Note 1:
Ga = Galvanized steel sheet metal gauge
w = Nominal test coupon width (in)
= Test coupon number

Figure 2
Blank Test Form

Verification Procedure for Tensile Test Apparatus Used for Quality Control Testing of Welded Seam Corrugated Metal Pipe (CMP)

1. Verification of CMP producer's quality control tensile testing equipment shall be done annually.
2. Six each, 4" wide x 8" long test specimens shall be cut perpendicular across the welds from a randomly selected production section of CMP, such that each specimen contains 4" of welded lock seam.
3. Test specimens shall be numbered 1-6 sequentially along the pipe, corrugations flattened, and a test coupon prepared from each specimen. Test specimens may be adjacent to each other.
4. Three test coupons pulled to failure shall constitute a tensile strength test.
5. Test coupons shall conform to the following dimensions:

Nominal Thickness	Galvanized Steel Sheet Gauge	Coupon dimensions		Gauge section	
		End Width	Length	Width	Length
0.0635"	16 Gauge	3" Max.	6-8"	0.80±.05"	2"
0.0785"	14 Gauge	3" Max.	6-8"	0.65±.05"	2"
0.1084"	12 Gauge	3" Max.	6-8"	0.50±.05"	2"
0.1382"	10 Gauge	3" Max.	6-8"	0.40±.05"	2"
0.1681"	8 Gauge	3" Max.	6-8"	0.30±.05"	2"

Radius from gauge section to coupon ends shall be 2". See Figure 1 for other dimensions.

6. Measure and record the thickness of the test coupon in the gauge section adjacent to the welded lock seam.
7. Measure and record the width of the test coupon in the gauge section at the welded lock seam.
8. Calculate the cross sectional area of the gauge section adjacent to the welded lock seam.
9. Coupons 1, 3, 5 shall be tested to failure with the CMP producer's tensile testing equipment. Coupons 2, 4, 6 shall be tested to failure by a certified or accredited independent lab.
10. Calculate tensile strength by dividing test load by cross sectional area.
11. Calculate average tensile strength of coupons in the test set (minimum of 3).
12. The producer's average tensile strength shall be within 5% of the independent lab strength test value.

Figure 2
Verification Procedure and Calculations
 (1 of 2)

Welded Lock Seam Tensile Testing of Corrugated Metal Pipe (CMP)										
Welded Seam CMP testing done by:		CONTECH Engineered Solutions LLC, Marvin Copley								
Test date:		March 21, 2017								
Test apparatus information:										
Apparatus name/Mfg:		Tensile Test Unit/Futek								
Model Number:		LCM375								
Max. load capacity (lb):		3000		Load resolution (lb):		1				
Loading rate (in/min):		0.2 ±10%		Loading mechanism:		Hand crank				
Digital or Analog display:		Digital		Load Cell Mfg./Model:		Dillon/FI-90				
Calibration Date:		Calibrated by:								
Material: Galvanized Steel Corrugated Metal Pipe										
Reference: AASHTO T 241, AASHTO M 218										
Minimum required base metal tensile strength (psi) =				45,000			90% of base metal strength req'd =			40,500
Coupon ID	Gauge (US Sheet)	Nominal Ga Thickness (in)	Measured Thickness (in)	Width (in)	Area (in ²)	Required Min Load (lb)	Test Load (lb)	Test Stress (psi)	Pass/Fail	
12-0.50-1	12	0.1084	0.1040	0.5040	0.0524	2120	2712	51,700	Pass	
12-0.50-2	12	0.1084	0.1040	0.5020	0.0522	2110	2411	46,200	Pass	
12-0.50-3	12	0.1084	0.1020	0.5050	0.0515	2090	2839	55,100	Pass	
							Average:		51,000	Pass

Note 1:
 Ga = Galvanized steel sheet metal gauge
 w = Nominal test coupon width (in)
 # = Test coupon number

Figure 2
 Verification Procedure and Calculations
 (2 of 2)

Terminology SP 1

1. Scope

This standard practice provides terminology as interpreted and defined by the State of Alaska. The definitions of the American Association of State Highway and Transportation Officials (AASHTO) are the ones most commonly followed by DOT&PF.

2. Definitions

Absorption: The increase in the mass of aggregate due to water being absorbed into the pores of the material, but not including water adhering to the outside surface of the particles, expressed as a percentage of the dry mass.

Acceptance sampling and testing: Sampling and testing performed by the State of Alaska, or its designated agent, to evaluate acceptability of the final product. This is also called verification sampling and testing when specifically used to validate the contractor's data.

Admixture: Material other than water, cement, and aggregates in Portland cement concrete (PCC).

Aggregate: Hard granular material of mineral composition, including sand, gravel, slag or crushed stone, used in roadway base and in Portland Cement Concrete (PCC) and Asphalt mixtures.

- **Coarse aggregate:** Aggregate retained on or above the 4.75 mm (No. 4) sieve.
- **Coarse-graded aggregate:** Aggregate having a predominance of coarse sizes.
- **Dense-graded aggregate:** Aggregate having a particle size distribution such that voids occupy a relatively small percentage of the total volume.
- **Fine aggregate:** Aggregate passing the 4.75 mm (No. 4) sieve.
- **Fine-graded aggregate:** Aggregate having a predominance of fine sizes.
- **Mineral filler:** A fine mineral product at least 70 percent of which passes a 75 μm (No. 200) sieve.
- **Open-graded gap-graded aggregate:** Aggregate having a particle size distribution such that voids occupy a relatively large percentage of the total volume.
- **Well-Graded Aggregate:** Aggregate having an even distribution of particle sizes.

Aggregate storage bins: Bins that store aggregate for feeding material to the dryer in an asphalt mixture plant in substantially the same proportion as required in the finished mix.

Agitation: Provision of gentle motion in Portland Cement Concrete (PCC) sufficient to prevent segregation and loss of plasticity.

Air voids: Total volume of the small air pockets between coated aggregate particles in asphalt concrete pavement; expressed as a percentage of the bulk volume of the compacted paving mixture.

Ambient temperature: Temperature of the surrounding air.

Angular aggregate: Aggregate possessing well-defined edges at the intersection of roughly planar faces.

Apparent specific gravity: The ratio of the mass, in air, of a volume of the impermeable portion of aggregate to the mass of an equal volume of water.

Asphalt mixture: A dark brown to black cementitious material in which the predominate constituents are bitumens occurring in nature or obtained through petroleum processing. Asphalt is a constituent of most crude petroleum.

Asphalt binder: Asphalt specially prepared in quality and consistency for use in the manufacture of asphalt mixture pavement.

Asphalt material: Asphalt binder, tack or additives.

Asphalt mixture batch plant: A manufacturing facility for producing asphalt mixture that proportions aggregate by weight and asphalt by weight or volume.

Asphalt mixture continuous mix plant: A manufacturing facility for producing asphalt concrete that proportions aggregate and asphalt by a continuous volumetric proportioning system without specific batch intervals.

Automatic cycling control: A control system in which the opening and closing of the weigh hopper discharge gate, the bituminous discharge valve, and the pug mill discharge gate are actuated by means of automatic mechanical or electronic devices without manual control. The system includes preset timing of dry and wet mixing cycles.

Automatic dryer control: A control system that automatically maintains the temperature of aggregates discharged from the dryer.

Automatic proportioning control: A control system in which proportions of the aggregate and asphalt material fractions are controlled by means of gates or valves that are opened and closed by means of automatic mechanical or electronic devices without manual control.

Bag (of cement): 94 lb of Portland cement. (Approximately 1 ft³ of bulk cement.)

Base: A layer of selected material constructed on top of subgrade or subbase and below the paving on a roadway.

Bias: The offset or skewing of data or information away from its true or accurate position as the result of systematic error.

Binder: Asphalt cement or modified asphalt cement that binds the aggregate particles into a dense mass.

Boulders: Rock fragment, often rounded, with an average dimension larger than 300 mm (12 in.).

Bulk Density: The mass per volume of a material, including any voids that may occur within the volume.

Bulk specific gravity: The ratio of the mass, in air, of a volume of aggregate or compacted asphalt mixture (including the permeable and impermeable voids in the particles, but not including the voids between particles) to the mass of an equal volume of water.

Bulk specific gravity (SSD): The ratio of the mass, in air, of a volume of aggregate or compacted asphalt mixture, including the mass of water within the voids (but not including the voids between particles), to the mass of an equal volume of water. (See **Saturated Surface Dry**.)

Calibration: A process that establishes the relationship (traceability) between the results of a measurement instrument, measurement system, or a material measure and the corresponding values assigned to a reference standard.

Check: A specific type of inspection and/or measurement performed on equipment and materials to indicate compliance or otherwise with stated criteria.

Clay: Fine-grained soil that exhibits plasticity over a range of water contents, and that exhibits considerable strength when dry. Also, that portion of the soil finer than 2 µm.

Cobble: Rock fragment, often rounded, with an average dimension between 75 and 300 mm (3 and 12 in.).

Cohesionless soil: Soil with little or no strength when dry and unconfined or when submerged, such as sand.

Cohesive soil: Soil with considerable strength when dry and that has significant cohesion when unconfined or submerged.

Compaction: Densification of a soil or asphalt **mixture** pavement by mechanical means.

Compaction curve (Proctor curve or moisture-density curve): The curve showing the relationship between the dry unit weight or density and the water content of a soil for a given compactive effort.

Compaction test (moisture-density test): Laboratory compaction procedure in which a soil of known water content is placed in a specified manner into a mold of given dimensions, subjected to a compactive effort of controlled magnitude, and the resulting density determined.

Compressibility: Property of a soil or rock relating to susceptibility to decrease in volume when subject to load.

Consolidation: In the placement of Portland cement concrete (PCC) it is the removal of entrapped air by either tamping or vibrating the material.

Constructor: The builder of a project. The individual or entity responsible for performing and completing the construction of a project required by the contract documents. Often called a contractor, since this individual or entity contracts with the owner.

Crusher-run: The total unscreened product of a stone crusher.

Delivery tolerances: Permissible variations from the desired proportions of aggregate and asphalt **binder** delivered to the pug mill.

Density: The ratio of mass to volume of a substance. Usually expressed in kg/m³ (lb/ft³).

Design professional: The designer of a project. This individual or entity may provide services relating to the planning, design, and construction of a project, possibly including materials testing and construction inspection. Sometimes called a “contractor”, since this individual or entity contracts with the owner.

Dryer: An apparatus that dries aggregate and heats it to specified temperatures.

Dry mix time: The time interval between introduction of aggregate into the pug mill and the addition of asphalt **binder**.

Durability: The property of concrete that describes its ability to resist disintegration by weathering and traffic. Included under weathering are changes in the pavement and aggregate due to the action of water, including freezing and thawing.

Effective diameter (effective size): D₁₀, particle diameter corresponding to 10 percent finer or passing.

Embankment: Controlled, compacted material between the subgrade and subbase or base in a roadway.

Field Operating Procedure (FOP): Procedure used in field testing on a construction site or in a field laboratory. (Based on AASHTO, ASTM or WAQTC test methods.)

Fineness modulus: A factor equal to the sum of the cumulative percentages of aggregate retained on certain sieves divided by 100; the sieves are 150 mm (6”), 75 mm (3”), 37.5 mm (1 ½”), 19.0 mm (¾”), 9.5 mm (3/8”), 4.75 mm (No. 4), 2.36 mm (No. 8), 1.18 mm (No. 16), 0.60 mm (No. 30), 0.30 mm (No. 50), and 0.15 mm mm (No. 100). Used in the design of concrete mixes. The lower the fineness modulus, the more water/cement paste that is needed to coat the aggregate.

Fines: Portion of a soil or aggregate finer than a 75 µm (No. 200) sieve. Also silts and clays.

Free water: Water on aggregate available for reaction with hydraulic cement. Mathematically, the difference between total moisture content and absorbed moisture content.

Glacial till: Material deposited by glaciation, usually composed of a wide range of particle sizes, which has not been subjected to the sorting action of water.

Gradation (grain-size or particle-size distribution): The proportions by mass of a soil or fragmented rock distributed by particle size.

Gradation analysis (grain size analysis, particle-size or sieve analysis): The process of determining grain-size distribution by separation of sieves with different size openings.

Hot aggregate storage bins: Bins that store heated and separated aggregate prior to final proportioning into the mixer.

Hot mix asphalt (HMA) / Asphalt Mixture: High quality, thoroughly controlled hot mixture of asphalt cement and well-graded, high quality aggregate. The term Warm Mix Asphalt (WMA) is interchangeable with Hot Mix Asphalt (HMA) in this Manual. See WMA for more information.

Hydraulic cement: Cement that sets and hardens by chemical reaction with water.

Independent assurance (IA): Activities that are an unbiased and independent evaluation of all the sampling and testing (or inspection) procedures used in the quality assurance program. [IA provides an independent verification of the reliability of the acceptance (or verification) data obtained by the process control and acceptance testing. The results of IA testing or inspection are not to be used as a basis of acceptance. IA provides information for quality system management.]

In situ: Rock or soil in its natural formation or deposit.

Liquid limit: Water content corresponding to the boundary between the liquid and plastic states.

Loam: A mixture of sand, silt and/or clay with organic matter.

Lot: A quantity of material to be controlled. It may represent a specified mass, a specified number of truckloads, a linear quantity, or a specified time period during production.

Manual proportioning control: A control system in which proportions of the aggregate and asphalt material fractions are controlled by means of gates or valves that are opened and closed by manual means. The system may or may not include power assisted devices in the actuation of gate and valve opening and closing.

Materials and methods specifications: Also called prescriptive specifications. Specifications that direct the Constructor (Contractor) to use specified materials in definite proportions and specific types of equipment and methods to place the material.

Maximum size: One sieve larger than nominal maximum size.

Maximum particle size: First sieve to retain any material.

Mesh: The square opening of a sieve.

Moisture content (Soils and Aggregate): The ratio, expressed as a percentage, of the mass of water in a material to the dry mass of the material.

Moisture content (Asphalt Mixture): The ratio, expressed as a percentage, of the mass of water in a material to the dry mass of the material.

Nominal maximum size: One sieve larger than the first sieve to retain more than 10 percent of the material using an agency specified set of sieves based on cumulative percent retained. Where large gaps between specification sieves exist, intermediate sieve(s) may be inserted to determine nominal maximum size.

Nuclear gauge: Instruments used to measure in-place density, moisture content, or asphalt content through the measurement of nuclear emissions.

Optimum moisture content (optimum water content): The water content at which a soil can be compacted to a maximum dry density by a given compactive effort.

Organic soil: Soil with a high organic content.

Paste: Mix of water and hydraulic cement that binds aggregate in Portland cement concrete (PCC).

Penetration: The consistency of an asphalt material, expressed as the distance in tenths of a millimeter (0.1 mm) that a standard needle vertically penetrates a sample of the material under specified conditions of loading, time, and temperature.

Percent compaction: The ratio of density of a soil, aggregate, or asphalt mixture in the field to maximum density determined by a standard compaction test, expressed as a percentage.

Plant screens: Screens located between the dryer and hot aggregate storage bins that separate the heated aggregates by size.

Plastic limit: Water content corresponding to the boundary between the plastic and the semisolid states.

Plasticity: Property of a material to continue to deform indefinitely while sustaining a constant stress.

Plasticity index: Numerical difference between the liquid limit and the plastic limit and, thus, the range of water content over which the soil is plastic.

Portland cement: Hydraulic cement produced by pulverizing Portland cement clinker.

Portland cement concrete (PCC): A controlled mix of aggregate, Portland cement, and water, and possibly other admixtures.

PCC batch plant: A manufacturing facility for producing Portland cement concrete.

Process control: See Quality control.

Proficiency samples: Homogeneous samples that are distributed and tested by two or more laboratories. The test results are compared to assure that the laboratories are obtaining the same results.

Pugmill: A shaft mixer designed to mix aggregate and cement.

Quality assurance (QA): (1) All those planned and systematic actions necessary to provide confidence that a product or facility will perform satisfactorily in service; or (2) making sure the quality of a product is what it should be. [QA addresses the overall process of obtaining the quality of a service, product, or facility in the most efficient, economical, and satisfactory manner possible. Within this broad context, QA includes the elements of quality control, independent assurance, acceptance, dispute resolution etc. The use of the term QA/QC or QC/QA is discouraged and the term QA should be used. QA involves continued evaluation of the activities of planning, design, development of plans and specifications, advertising and awarding of contracts, construction, and maintenance, and the interactions of these activities.]

Quality assurance specifications: Specifications that require contractor quality control and agency acceptance activities throughout production and placement of a product. Final acceptance of the product is usually based on a statistical sampling of the measured quality level for key quality characteristics. [QA specifications typically are statistically based specifications that use methods such as random sampling and lot-by-lot testing, which let the contractor know if the operations are producing an acceptable product.]

Quality control (QC): Also called *process control*. The system used by a contractor to monitor, assess and adjust their production or placement processes to ensure that the final product will meet the specified level of

quality. Quality control includes sampling, testing, inspection and corrective action (where required) to maintain continuous control of a production or placement process.

Reclaimed Asphalt Pavement (RAP): The term given to removed and/or reprocessed pavement materials containing asphalt and aggregates. These materials are typically generated when asphalt pavements are removed either by milling or full-depth removal. When properly crushed and screened, RAP consists of high-quality, well-graded aggregates coated by asphalt **binder** that may be recycled as a portion of new asphalt **mixture** pavement.

Random sampling: Procedure for obtaining non-biased, representative samples.

Sand: Particles of rock passing the 4.75 mm (No. 4) sieve and retained on the 75 μm (No. 200) sieve.

Saturated surface dry (SSD): Condition of an aggregate particle, asphalt **mixture** pavement or Portland cement concrete (PCC) core, or other porous solid when the permeable voids are filled with water, but no water is present on exposed surfaces. (See bulk specific gravity.)

Segregation: The separation of aggregate by size resulting in a non-uniform material.

SHRP: The Strategic Highway Research Program (SHRP) established in 1987 as a five-year research program to improve the performance and durability of roads and to make those roads safe for both motorists and highway workers. SHRP research funds were partly used for the development of performance-based specifications to directly relate laboratory analysis with field performance.

Sieve: Laboratory apparatus consisting of wire mesh with square openings, usually in circular or rectangular frames.

Silt: Material passing the 75 μm (No. 200) sieve that is non-plastic or very slightly plastic, and that exhibits little or no strength when dry and unconfined. Also, that portion of the soil finer than 75 μm and coarser than 2 μm .

Slump: Measurement related to the workability of concrete.

Soil: Natural occurring sediments or unconsolidated accumulations of solid particles produced by the physical and chemical disintegration of rocks, and which may or may not contain organic matter.

Specific gravity: The ratio of the mass, in air, of a volume of a material to the mass of an equal volume of water.

Stability: The ability of an asphalt concrete to resist deformation from imposed loads. Stability is dependent upon internal friction, cohesion, temperature, and rate of loading.

Standard Density: A lab or field derived density value used to determine relative compaction in the field.

Standardization: A process that determines (1) the correction or correction factor to be applied to the result of a measuring instrument, measuring system, material measure or reference material when its values are compared to the values realized by standards, (2) the adjustment to be applied to a piece of equipment when its performance is compared with that of an accepted standard or process.

Stratified random sampling: Procedure for obtaining non-biased, representative samples in which the established lot size is divided into equally-sized sublots.

Subbase: A layer of selected material constructed between the subgrade and the base course in a flexible asphalt **material** pavement roadway, or between the subgrade and Portland Cement Concrete (PCC) pavement in a rigid PCC roadway.

Subgrade: Natural soil prepared and compacted to support a structure or roadway pavement.

Sublot: A segment of a lot chosen to represent the total lot.

Superpave™: Superpave™ (Superior Performing Asphalt Pavement) is a trademark of the Strategic Highway Research Program (SHRP). Superpave™ is a product of the SHRP asphalt research. The Superpave™ system

incorporates performance-based asphalt materials characterization with design environmental conditions to improve performance by controlling rutting, low temperature cracking and fatigue cracking. The three major components of Superpave™ are the asphalt binder specification, the mix design and analysis system, and a computer software system.

Theoretical maximum specific gravity (Asphalt Material): The ratio of the mass of a given volume of asphalt mixture with no air voids to the mass of an equal volume of water, both at a stated temperature commonly referred to as the “Rice” value.

Theoretical maximum specific gravity (PCC): The ratio of a given volume of PCC with no air voids to the mass of an equal volume of water, at a stated temperature. Usually determined during the concrete mix design. Can be used to determine percent air in concrete, in conjunction with field determined unit weights.

Topsoil: Surface soil, usually containing organic matter.

Traceability: The property of a result of a measurement whereby it can be related to stated references, usually national or international standards, through an unbroken chain of comparisons all having stated uncertainties.

Uncertainty: A parameter associated with the result of a measurement that defines the range of the values that could be attributed to the measured quantity.

Uniformity coefficient: C_u , a value employed to quantify how uniform or well-graded an aggregate is: $C_u = D_{60}/D_{10}$. 60 percent of the aggregate, by mass, has a diameter smaller than D_{60} and 10 percent of the aggregate, by mass, has a diameter smaller than D_{10} .

Unit weight: The ratio of weight to volume of a substance. The term “density” is more commonly used.

µm: Micro millimeter (micron) used as measurement for sieve size.

Verification of calibration: A process that establishes whether the results of a previously calibrated measurement instrument, measurement system, or material measure are stable.

Verification sampling and testing: See acceptance sampling and testing.

Viscosity: A measure of the resistance to flow; one method of measuring the consistency of asphalt.

- **Absolute viscosity:** A method of measuring viscosity using the “poise” as the basic measurement unit. This method is used at a temperature of 60°C, typical of hot pavement.
- **Kinematic viscosity:** A method of measuring viscosity using the stoke as the basic measurement unit. This method is used at a temperature of 135°C, typical of hot asphalt at a plant.

Void in the mineral aggregate (VMA): The volume of inter-granular void space between aggregate particles of compacted asphalt concrete pavement that includes air and asphalt; expressed as a percentage of the bulk volume of the compacted paving mixture.

Void filled with asphalt: The portion of the void in the mineral aggregate (VMA) that contains asphalt; expressed as a percentage of the bulk volume of mix or the VMA.

Warm Mix Asphalt (WMA): The generic term for a variety of technologies that allow the producers of asphalt mixtures material to lower the temperatures at which the material is mixed and placed on the road. Reductions from asphalt mixture temperatures of 50 to 100 degrees Fahrenheit are documented. Three general technologies are used at this time to decrease the mix and compaction temperatures including: chemical additives, organic additives (waxes) and foaming with water. Sampling and testing of WMA is done the same as with asphalt mixtures so these terms are interchangeable in this Manual.

Wet mixing period: The time interval between the beginning of application of asphalt material and the opening of the mixer gate.

Zero air voids curve (saturation curve): Curve showing the zero air voids density as a function of water content. Points that define the curve are calculated in accordance with the addendum of WAQTC FOP for AASHTO T 99/ T 180.

Calibration of Mechanical Compaction Hammer/Rammer SP 2

1. Scope

This practice sets forth the apparatus, procedures, and materials necessary to calibrate a mechanical compaction hammer used in ATM 417, WAQTC FOP for AASHTO T 99/T 180, AASHTO T 245; and ASTM D 698/D 1557 in accordance with ASTM D 2168 Test Method A.

There are two parallel procedures providing instruction for verification of physical characteristics and calibration of dynamic characteristics for manual and mechanical Soils and Marshall compaction hammers and compaction pedestals. Physical Characteristics are examined first, verifying mass and critical dimensions of the manual and mechanical compaction hammers and compaction pedestals.

Warning – This test method involves potentially hazardous materials, operations and equipment. This method does not purport to address all of the safety problems associated with it use.

2. Apparatus

- Hand-operated compaction hammers and compaction pedestals conforming to the requirements of WAQTC FOP for AASHTO T 99/T 180, AASHTO T 245; and ASTM D 698/D 1557.
- Mechanical compaction hammers and pedestals conforming to the requirements of ATM 417, WAQTC FOP for AASHTO T 99/T 180, AASHTO T 245, and ASTM D 698/D 1557.
- Proctor and Marshall compaction molds, bases, collars and rubber plugs (roughly 50 mm (2”) thick and cut to fit bottom of mold).
- Caliper capable of measuring to an accuracy of 0.005 inch.
- Calibrated ruler readable to 1/32 inch.
- Balance readable to 0.1 gram equipped with suspension apparatus and holder to permit weighing materials while suspended from the center of the scale in a water bath.
- Asphalt thermometer capable of measuring the hot-mix-asphalt temperature to within 5⁰ F
- Oven: For asphalt set to 135°C (275°F), or specified compaction temperature, molds, tools and accessories required to prepare and extract six (6) Marshall Specimens.

3. Procedure for Verification of Physical Characteristics

Inspect and adjust the mechanical and hand-operated compaction hammers to conform to the requirements of ATM T 417, WAQTC FOP for AASHTO T 99/ T 180, AASHTO T 245; and ASTM D698 & D1557.

4. Physical Characteristics of Hand-Operated Manual Hammer and Pedestal

1. Asphalt: Inspect and adjust manual Marshall Hammer and compaction pedestal.
 - a. Using the caliper, measure and record the diameter of the rammer face by taking two readings 90° apart. The diameter of the face should average a minimum of 3.875 inches measured to the nearest 0.005 inch.
 - b. Lift the sliding weight up to the top of the guide rod and measure the drop height of the sliding weight to the nearest 1/16 inch from the bottom of the sliding weight face to the top of the foot sleeve, record measurement. The sliding weight should have a free fall of 18 ± 0.0625 (1/16) inch. Record measurement in decimal form.

- c. Remove the handle and sliding hammer weight from the guide rod. Weigh and record the slide weight mass to the nearest 1 gram. The hand-operated hammer should have a $4,536 \pm 9$ gram (10 ± 0.02 lbs.) sliding weight (including safety finger guard if equipped).
 - d. Measure and record the dimensions of the wooden post and the steel plate portions of the pedestal. Pedestals should consist of an 8 x 8 x 18 inch wooden post capped with a 12 x 12 x 1 inch steel plate. Verify sturdy construction of the pedestal: The wooden post should be free of cracks or splits and be secured by four angle brackets to a solid concrete slab with the steel cap firmly fastened to the post. The assembly shall be installed so the post is plumb and the cap is level.
2. Soils: Inspect and adjust manual Proctor hammer and compaction pedestal for conformance to AASHTO T 99 or T 180, or for ASTM D698 or D1557.

5. Physical Characteristics of Mechanically Operated Hammer and Pedestal

1. Asphalt: Inspect and adjust the mechanical Marshall Hammer as done in Part 4. Steps 1a, 1b, and 1c. When measuring the slide weight free fall dimension, raise the slide weight up the guide rod until the pick-up pins recede by contact with the disengagement bar, measure and record height from bottom of slide weight face to the top of the foot sleeve. When weighing slide weight, remove disengagement assembly from the top of the guide rod and slide weight off rod.
 - a. Measure and record the dimensions of the wooden post and the steel plate portions of the pedestal. Pedestals should consist of an 8 x 8 x 18 inch wooden post capped with a 12 x 12 x 1 inch steel plate.
 - b. Verify sturdy construction of the pedestal: The wooden post should be free of cracks or splits and be secured by four angle brackets to a solid concrete slab with the steel cap firmly fastened to the post. The assembly shall be installed so the post is plumb and the cap is level.
2. Soils: Inspect and adjust mechanical Proctor hammer and compaction pedestal for conformance to AASHTO T 99 or T 180, or for ASTM D698 or D1557. Note ASTM D1557 allows use of a sector face hammer.

6. Procedure for Calibration of Dynamic Characteristics of Asphalt Mixes

1. Asphalt preparation:
 - a. If asphalt sample is workable, split into at least six equal portions of 1250 ± 5 grams using the WAQTC Loaf Method. Place the six equal portions and the remaining asphalt into the oven and heat to compaction temperature, typically $135 \pm 5^\circ\text{C}$ ($275 \pm 9^\circ\text{F}$). If not workable, place asphalt into oven and allow time for asphalt to return to a plastic state so splitting can be accomplished, split as indicated above, then return the six equal portions and the remaining asphalt to the oven to obtain compaction temperature.
 - b. Place Marshall mold assemblies and other asphalt handling tools in oven to preheat to compaction temperature. Use hot plate or oven to heat compaction face of mechanical and manual compaction hammers to $93 - 149^\circ\text{C}$ ($200 - 300^\circ\text{F}$).
2. Once asphalt and other materials have reached compaction temperature, use the extra asphalt to butter the mixing bowl and specimen preparation tools. Loosen up the mechanical compactor mechanism by compacting a portion of the extra asphalt with a minimum of 25 blows. Discard the partially compacted asphalt used to “warm up” the mechanical compactor. Next, alternately compact a Marshall Specimen using the manual compaction hammer and a Marshall Specimen using the mechanical compaction hammer, until three specimens have been produced by each method. Follow the steps below in preparing the specimens.
 - a. Remove one Marshall base, mold, and collar assembly from oven when ready to use. Place filter paper in the bottom of the mold.

- b. Remove one asphalt portion from oven, place in a mixing bowl, vigorously and briefly mix asphalt and scoop into mold assembly. Using the spatula, vigorously spade the asphalt in the mold 15 times around the perimeter and then 10 times over the interior. Smooth surface of the asphalt in the mold to a rounded, convex shape.
 - c. Place a piece of filter paper on top of asphalt in mold, place mold assembly on compaction pedestal and secure with mold holder.
 - d. Apply 50 blows, unless otherwise specified, of compaction effort. (Manual Hammer notes: Hold the hammer axis perpendicular to the mold assembly. AASHTO allows use of a guide bar fixed to the compaction pedestal to maintain perpendicular alignment of the hammer. ASTM prohibits use of guide bar as the natural wandering from true perpendicular produces a kneading action that enhances compaction. Care shall be taken to avoid adding body weight to the hammer by leaning or pressing down on the hammer. Compaction shall be done at a minimum rate of 40 blows per minute. The compaction hammer shall apply only one blow with each fall - that means there shall not be a rebound impact.)
 - e. Remove mold holder and collar, remove mold from base plate and flip over (180° turn), return mold to base plate, replace collar and mold holder, and apply an additional 50 blows of compaction effort.
 - f. Remove mold assembly from compaction pedestal; remove collar and base plate from mold specimen, set mold with specimen aside to cool until cohesion of the sample will allow specimen extraction from the mold. (When specimens in the steel mold have cooled to the point where they can be handled without gloves, generally below 60°C (140°F), they can be extracted from the molds without damage if handled carefully.) Marshall Specimens should be allowed to cool over night at room temperature; however cooling may be accelerated by the use of fans.
 - g. Clean surfaces of compaction equipment used.
3. Perform specific gravity measurements for each Marshall specimen according to AASHTO T 166, Method A.
 - a. Measure and record dry weight of cooled specimen.
 - b. Immerse specimen in water bath at $25 \pm 1^\circ\text{C}$ ($77 \pm 1.8^\circ\text{F}$) for 4 ± 1 minute and record the immersed mass.
 - c. Remove the specimen from the water and quickly damp dry the specimen with a damp towel to produce a saturated surface dry condition, record the surface dry mass of the specimen.

7. Calibration Comparison and Adjustment for Asphalt Mixes

1. Calculate the bulk specific gravity of the specimens as follows, round and report to the nearest three decimal places, or thousandth:

$$\text{Bulk Specific Gravity} = A / (B - C)$$

Where:

- A = mass in grams of sample in air;
- B = mass in grams of surface-dry specimen in air; and
- C = mass in grams of sample in water.

(Within each set prepared by a given hammer the densities shall not differ by more than 2.5 pcf for ½" and ¾" mix and 3.0 pcf for 1" mix. If density consistency is not met then specimens shall be discarded and a new set of specimens prepared.)

2. Calculate the percent water absorbed by specimens (on volume basis) as follows:

$$\text{Percent Water Absorbed by Volume} = [(B-A) / (B-C)] * 100$$

If percent water absorbed by the specimen is greater than 2% then paraffin coated specimens must be used to verify the mechanical compactor with the manual compactor. See AASHTO T275 or ASTM D1188.

3. Calculate the average specific gravity values for the mechanically compacted and the manually compacted specimens independently.
4. Calculate W , the percentage difference between the average specific gravity values for the two compaction methods. Calculation:

$$W = \% \text{ Difference} =$$

$$|(\text{manual method avg. sp. G.} - \text{mechanical method avg. Sp. G.})| * 100 / (\text{manual method avg. Sp. G.})$$

If the absolute value of the difference between the results of the mechanical vs. the manual compaction method is 2.0% or less, the mechanical compaction hammer is ready for use.

5. If the difference is greater than 2.0%, adjust the weight or of the mechanical hammer and repeat the procedure until the mean value of the mechanical compaction hammer data varies from the mean value of the manual hammer data by 2.0% or less.

8. Procedure for Calibration of Dynamic Characteristics of Soils

1. Obtain at least 30 kg (66 lb) of soil classified as CL in accordance with Unified Soil Classification (ASTM D 2487) with liquid limit less than 50 and PI greater than 7. (ARML soil compaction samples typically meet this classification.)
2. Assure all the soil passes a #4 sieve and is at less than 3% moisture. Dry at 60⁰ C or less, if needed. Pass material through splitter to assure uniform mixing.
3. Split out 5 portions of approximately 6500g each. Batch 5 moisture points, cover with plastic wrap and allow points to sit overnight to assure complete hydration of material. Using approximately 3, 5, 7, 9, 11% moisture typically works well for AMRL compaction sample material (Review the AMRL summary report and adjust moisture range as required for the reported proctor result. Use the reported optimum moisture and maximum density to double check the calibration specimen values.)
4. Using soil, as prepared above, determine the optimal moisture and maximum dry unit weight by the method appropriate for the mechanical compactor being calibrated. Pound each moisture point with both the mechanical and manual hammer, passing the sample through the #4 sieve before re-compacting. Be careful to minimize drying of sample while re-sieving material.
5. Plot data points and determine the moisture/density curve for the manual and mechanical hammers.

9. Calibration Comparison and Adjustment for Soils

1. If W , the absolute value of the difference between the two maximum dry unit weights is less than 2.0%, the mechanical hammer is satisfactory for immediate use. If the difference W is greater than 2.0%, then obtain **TWO** additional sets of data, reusing the previously used soil. Determine W for the average of the three data sets for mechanical and manual hammer. If W is less than 2.0%, the mechanical hammer is satisfactory for use.
2. If W exceeds 2.0%, then add weight to or reduce the drop height of the mechanical hammer until 3 data sets are obtained with W less than 2.0%. If addition of greater than 10% of the mechanical hammer weight is needed, the mechanical compactor needs to be adjusted or rebuilt. If weight needs to be removed from the mechanical hammer, recheck and verify all hammer weight and drop height calibrations. If weight removal is **STILL** indicated, then reduce drop height to obtain W less than 2.0%.

10. Report

1. Calibrate all compaction hammers every 12 months or prior to use if the existing calibration is more than one (1) year old.
2. File original calibration certificate and test data with the calibrating laboratory.
3. Keep a copy of the calibration certificate with the Compaction Hammer.

This page intentionally left blank.

Reserved for WAQTC Discipline Policy SP 3

This page intentionally left blank.

Random Sampling SP 4

1. Significance

Sampling and testing are two of the most important functions in quality assurance (QA). Data from the tests are the tools with which the quality of product is controlled. For this reason, great care must be used in following standardized sampling and testing procedures. This practice is useful for determining the location or time, or both, to take a sample in order to minimize any unintentional bias on the part of the person taking the sample.

The selection procedures and examples in this standard provide a practical approach for ensuring that construction material samples are obtained in a random manner. Additional details concerning the number of sample increments, the number of samples, the quantities of material in each, and the procedures for extracting sample increments or samples from the construction lot or process are contained in the Materials Samples and Testing Frequency tables and the individual test procedures. This standard contains examples using road and paving materials. The concepts outlined here are applicable to the random sampling of any construction material.

2. Scope

The procedure presented here eliminates bias in sampling materials when followed carefully. Randomly selecting a set of numbers from a table or calculator will eliminate the possibility for bias. Random numbers are used to identify sampling times and/or locations within a lot or subplot. This method does not cover how to sample, but rather how to determine sampling times and/or locations.

3. Sampling Concepts

A lot is the quantity of material evaluated by QA procedures. A lot is a preselected quantity that may represent hours of production, a quantity or number of loads of material, or an interval of time. A lot may be comprised of several portions that are called sublots or units. The number of sublots comprising a lot will be determined by DOT&PF's specifications

Stratified Random Sampling: Stratified random sampling divides the lot into a specified number of sublots or units and then determines each sample location within a distinct subplot.

All random sampling shall be stratified random sampling unless otherwise directed.

Stratified Random Sampling
The lot is divided into two or more equal sublots. Samples are taken from each subplot

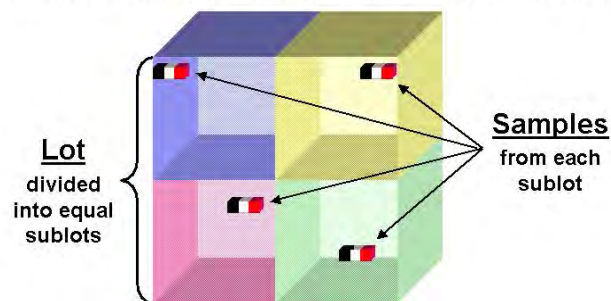

4. Instructions for Using the Three-Digit Table of Random Numbers

Table 1 consists of 1,000 numbers from 0.000 to 0.999. Each number appears only once in the Table of 100 rows by 10 columns. The Table is most effectively used when a row and column are randomly selected and the

entered value from the Table is then used for sample selection. Several methods of selection of row and column are available including:

Use of the RANDOM function in pocket calculators (if available) to select row and column. For example, for selection of row: the RANDOM function generates 0.620. Then the row to be used is $0.620 \times$ the number of rows = $0.620(100) = 62.0$ or 62. Likewise for the column, the RANDOM function generates 0.958 and the column is $0.958 (10) = 9.58$ or 10. The random number to be used for the sample is in row 62, column 10 = 0.460.

Similarly, if Microsoft Excel is available, the RAND function can be used to generate random numbers for selection of row and column. This can be accomplished by selecting an open cell in Excel entering: =RAND() or: =rand(). Do this once for a row and a second for column, multiplying as explained above.

Start a digital stop watch and stop it several seconds later, using the decimal part of the seconds as multipliers to determine your Row/Column number(s).

Table 1

Row\ Column	1	2	3	4	5	6	7	8	9	10
1	0.910	0.921	0.889	0.985	0.697	0.562	0.701	0.284	0.534	0.519
2	0.769	0.814	0.210	0.758	0.846	0.113	0.312	0.716	0.975	0.729
3	0.722	0.220	0.726	0.942	0.825	0.177	0.120	0.558	0.979	0.451
4	0.872	0.772	0.338	0.374	0.000	0.387	0.491	0.647	0.445	0.053
5	0.850	0.836	0.145	0.216	0.270	0.109	0.590	0.882	0.740	0.434
6	0.291	0.780	0.782	0.306	0.470	0.712	0.252	0.630	0.231	0.694
7	0.295	0.502	0.615	0.541	0.765	0.092	0.376	0.523	0.551	0.733
8	0.761	0.370	0.278	0.288	0.256	0.352	0.064	0.195	0.334	0.652
9	0.790	0.750	0.402	0.182	0.577	0.391	0.214	0.481	0.680	0.348
10	0.547	0.011	0.355	0.587	0.359	0.310	0.192	0.545	0.487	0.925
11	0.868	0.049	0.505	0.139	0.705	0.007	0.633	0.754	0.124	0.280
12	0.384	0.968	0.483	0.203	0.513	0.583	0.637	0.477	0.957	0.515
13	0.996	0.665	0.658	0.412	0.149	0.673	0.103	0.344	0.619	0.263
14	0.804	0.242	0.662	0.135	0.248	0.173	0.398	0.459	0.744	0.156
15	0.440	0.331	0.128	0.737	0.529	0.313	0.683	0.839	0.636	0.245
16	0.042	0.027	0.337	0.142	0.196	0.036	0.516	0.074	0.666	0.277
17	0.497	0.903	0.444	0.822	0.886	0.230	0.463	0.234	0.185	0.068
18	0.508	0.999	0.469	0.480	0.448	0.544	0.121	0.260	0.843	0.078
19	0.672	0.871	0.540	0.025	0.548	0.978	0.495	0.138	0.202	0.281
20	0.031	0.059	0.241	0.431	0.897	0.198	0.559	0.946	0.206	0.003
21	0.775	0.668	0.441	0.993	0.644	0.634	0.591	0.604	0.341	0.865
22	0.174	0.100	0.324	0.651	0.935	0.110	0.292	0.747	0.213	0.249
23	0.465	0.309	0.961	0.006	0.401	0.950	0.038	0.305	0.907	0.166
24	0.369	0.046	0.484	0.170	0.377	0.416	0.640	0.967	0.399	0.608
25	0.597	0.864	0.063	0.725	0.146	0.687	0.330	0.394	0.693	0.928
26	0.052	0.629	0.351	0.586	0.896	0.020	0.860	0.490	0.881	0.913
27	0.892	0.922	0.360	0.253	0.127	0.067	0.189	0.815	0.084	0.018
28	0.832	0.159	0.178	0.618	0.800	0.255	0.890	0.456	0.757	0.383
29	0.095	0.349	0.157	0.426	0.554	0.992	0.413	0.885	0.924	0.148

Row\ Column	1	2	3	4	5	6	7	8	9	10
30	0.778	0.981	0.237	0.906	0.703	0.970	0.874	0.810	0.949	0.472
31	0.917	0.767	0.002	0.714	0.899	0.867	0.824	0.326	0.621	0.561
32	0.760	0.593	0.589	0.696	0.835	0.600	0.856	0.682	0.415	0.518
33	0.180	0.625	0.550	0.447	0.817	0.689	0.614	0.582	0.678	0.646
34	0.301	0.532	0.329	0.500	0.436	0.575	0.536	0.564	0.671	0.372
35	0.397	0.258	0.653	0.290	0.557	0.418	0.358	0.386	0.888	0.322
36	0.080	0.347	0.244	0.251	0.176	0.187	0.443	0.212	0.315	0.977
37	0.379	0.155	0.411	0.507	0.009	0.041	0.308	0.169	0.137	0.066
38	0.062	0.201	0.831	0.297	0.098	0.998	0.265	0.105	0.094	0.927
39	0.863	0.884	0.916	0.183	0.895	0.130	0.948	0.087	0.920	0.215
40	0.717	0.781	0.984	0.037	0.909	0.706	0.973	0.304	0.877	0.802
41	0.635	0.667	0.934	0.795	0.763	0.592	0.158	0.699	0.838	0.656
42	0.624	0.891	0.731	0.806	0.692	0.617	0.585	0.681	0.980	0.649
43	0.012	0.660	0.457	0.482	0.724	0.553	0.745	0.820	0.503	0.439
44	0.364	0.546	0.514	0.343	0.571	0.407	0.610	0.866	0.336	0.535
45	0.400	0.720	0.261	0.293	0.560	0.421	0.389	0.425	0.218	0.325
46	0.179	0.446	0.279	0.318	0.777	0.243	0.211	0.307	0.222	0.275
47	0.133	0.140	0.969	0.076	0.033	0.631	0.236	0.161	0.396	0.129
48	0.311	0.172	0.663	0.752	0.930	0.154	0.122	0.197	0.485	0.983
49	0.015	0.250	0.517	0.951	0.090	0.855	0.165	0.880	0.805	0.816
50	0.869	0.837	0.848	0.741	0.773	0.008	0.784	0.040	0.912	0.709
51	0.926	0.627	0.958	0.894	0.734	0.723	0.638	0.670	0.937	0.798
52	0.314	0.791	0.047	0.727	0.556	0.823	0.282	0.620	0.588	0.492
53	0.378	0.645	0.136	0.403	0.474	0.346	0.410	0.613	0.435	0.264
54	0.257	0.531	0.499	0.150	0.385	0.289	0.086	0.111	0.353	0.079
55	0.698	0.004	0.175	0.143	0.972	0.997	0.029	0.061	0.965	0.093
56	0.940	0.730	0.794	0.762	0.826	0.858	0.648	0.616	0.787	0.584
57	0.829	0.900	0.953	0.793	0.274	0.566	0.423	0.117	0.809	0.254
58	0.466	0.989	0.419	0.395	0.936	0.579	0.914	0.643	0.286	0.083
59	0.299	0.224	0.449	0.776	0.060	0.473	0.235	0.417	0.898	0.097
60	0.227	0.238	0.205	0.302	0.748	0.878	0.017	0.601	0.186	0.987
61	0.085	0.131	0.526	0.075	0.163	0.430	0.363	0.032	0.104	0.019
62	0.039	0.537	0.043	0.259	0.141	0.494	0.171	0.609	0.428	0.460
63	0.188	0.088	0.654	0.690	0.316	0.438	0.808	0.964	0.193	0.549
64	0.167	0.152	0.462	0.267	0.320	0.160	0.641	0.199	0.677	0.901
65	0.342	0.096	0.099	0.622	0.786	0.028	0.569	0.947	0.755	0.990
66	0.611	0.818	0.932	0.857	0.081	0.408	0.427	0.840	0.207	0.168
67	0.077	0.686	0.594	0.605	0.573	0.669	0.380	0.246	0.908	0.876
68	0.107	0.801	0.718	0.498	0.893	0.707	0.530	0.797	0.453	0.350
69	0.598	0.327	0.406	0.904	0.675	0.626	0.509	0.861	0.382	0.414
70	0.184	0.366	0.555	0.455	0.021	0.323	0.684	0.071	0.268	0.108

Row\ Column	1	2	3	4	5	6	7	8	9	10
71	0.153	0.164	0.132	0.228	0.939	0.070	0.209	0.527	0.887	0.919
72	0.057	0.452	0.266	0.089	0.356	0.217	0.971	0.974	0.051	0.574
73	0.420	0.807	0.732	0.303	0.715	0.743	0.014	0.580	0.873	0.830
74	0.388	0.512	0.833	0.982	0.676	0.373	0.768	0.405	0.659	0.862
75	0.779	0.501	0.736	0.679	0.538	0.010	0.273	0.335	0.581	0.371
76	0.612	0.796	0.764	0.572	0.437	0.576	0.409	0.704	0.467	0.232
77	0.294	0.271	0.811	0.602	0.700	0.995	0.433	0.854	0.239	0.933
78	0.875	0.262	0.367	0.929	0.102	0.623	0.476	0.711	0.819	0.915
79	0.655	0.181	0.345	0.506	0.106	0.570	0.918	0.134	0.528	0.496
80	0.963	0.285	0.650	0.024	0.317	0.520	0.565	0.960	0.542	0.147
81	0.050	0.223	0.986	0.522	0.125	0.751	0.988	0.956	0.300	0.001
82	0.114	0.783	0.533	0.056	0.221	0.381	0.789	0.287	0.058	0.026
83	0.911	0.392	0.847	0.849	0.319	0.298	0.943	0.362	0.944	0.606
84	0.828	0.719	0.954	0.708	0.552	0.458	0.424	0.853	0.905	0.691
85	0.116	0.821	0.191	0.082	0.879	0.488	0.661	0.035	0.595	0.702
86	0.739	0.938	0.045	0.746	0.013	0.504	0.842	0.735	0.759	0.442
87	0.728	0.803	0.771	0.091	0.632	0.664	0.931	0.792	0.225	0.328
88	0.753	0.710	0.475	0.945	0.785	0.657	0.454	0.721	0.118	0.200
89	0.486	0.543	0.034	0.511	0.340	0.404	0.799	0.607	0.883	0.022
90	0.639	0.479	0.269	0.468	0.354	0.365	0.333	0.429	0.464	0.229
91	0.461	0.226	0.123	0.390	0.525	0.493	0.568	0.283	0.115	0.044
92	0.422	0.240	0.208	0.219	0.272	0.112	0.742	0.144	0.065	0.204
93	0.966	0.073	0.030	0.233	0.361	0.596	0.126	0.276	0.994	0.962
94	0.151	0.119	0.194	0.450	0.991	0.959	0.055	0.023	0.072	0.841
95	0.852	0.685	0.162	0.774	0.845	0.738	0.770	0.005	0.339	0.976
96	0.813	0.952	0.069	0.539	0.941	0.048	0.749	0.016	0.766	0.695
97	0.603	0.859	0.628	0.902	0.870	0.827	0.393	0.923	0.812	0.524
98	0.489	0.510	0.521	0.756	0.713	0.478	0.788	0.247	0.296	0.563
99	0.578	0.101	0.567	0.674	0.834	0.375	0.642	0.471	0.321	0.844
00	0.332	0.599	0.955	0.688	0.190	0.357	0.368	0.432	0.054	0.851

5. Alternate Procedures for Random Number Selection

Random numbers may be generated using the RANDOM function in pocket calculators and spreadsheets. For example, the RANDOM function generates 0.620. The number 0.620 should be entered as the random number and multiplied by the quantity under consideration to determine the sample location.

Similarly, if Microsoft Excel is available, the RAND function can be used to generate random numbers for selection of the sample location.

6. Random Number Sampling Procedures

Determine the number of random numbers necessary for each sample location from Table 2.

Table 2

Sample Type or WAQTC Method	# of Random Numbers Required
Oil from plant or truck	1
T 2/T 168 from Belt	1
T 2/T 168 from Truck	1
T 2/T 168 from Roadway	2
T 2/T 168 from Windrow	1
TM 11 Core	2
TM 2 Plastic Concrete	1
TP 83 Grout	1

Multiply the random number by the unit quantity in each subplot to determine sample location. When a sample is taken from a discrete location such as a truck load, and the sample method treats the load as a unit, sample per the procedure from the truck that contains the determined location.

Sample locations are for that sample only and are not reused for other samples. This would apply for samples of in place soil, aggregate, hot mix asphalt or cores. Each would require a separate set of random numbers. When two random numbers are used, such as in hot mix asphalt, the first random number would be multiplied by the length to determine where the sample would be taken along the project. The second would be multiplied by the width to determine where, widthwise, the sample would be taken.

When a test procedure does not allow tests from a portion of the lot being considered, those areas may be deleted from consideration. As an example, paving is 14 feet wide but testing does not allow tests within one foot of the edge. Testing must be done only in the 12 foot section in the middle of the width.

Two random numbers Example:

Given: Sublot length = 3,342 feet (when the 1 foot edge removed, we consider just 3340 feet)
Sublot width = 14 feet (when the 1 foot edge removed, we consider just 12 feet)
Random numbers for Row = 0.0262 and 0.3687
Random numbers for Column = 0.1696 and 0.3410

Find: length and width locations of sample

Solution: First Row number is: $100(0.0262) = 2.62$ or Row 3

First Column number is: $10(0.1696) = 1.696$ or Column 2

From Table 1, Row 3, Column 2, the random number for Length is: 0.220

So the sample location for length is: $0.220(3,340') = 734.8$ or 735' from beginning
If sampling material requiring only 1 random number this sample is located.

Second Row number is: $100(0.3687) = 36.87$ or Row 37

Second Column number is: $10(0.3410) = 3.41$ or Column 3

From Table 1, Row 37, Column 3, the random number for width is: 0.411

So the sample location for width is: $12(0.411) = 5'$ from the left edge of the subplot

When developing a sampling plan, determine a new set of random numbers for each sample required. For example, if the testing frequency specified indicates there will be twenty samples from a material, determine twenty different random number identified locations for the plan.

Additional examples are available in the Random Number section of all WAQTC modules and in ASTM D3665.

This page intentionally left blank.

ACI 301 Reference SP 5

1. Scope

This standard practice provides a table of equivalents when using ACI Concrete design methods. Since ACI uses ASTM exclusively, this table provides a reference to determine appropriate methods that are standard with DOT&PF.

ASTM	Title	WAQTC/AASHTO
A184	Standard Specification for Welded Deformed Steel Bar Mats for Concrete Reinforcement	M 54
A 185	Standard Specification for Steel Welded Wire Reinforcement, Plain, for Concrete	M 55
A 416	Standard Specification for Steel Strand, Uncoated Seven-Wire for Prestressed Concrete	M 203
A 421	Standard Specification for Uncoated Stress-Relieved Steel Wire for Prestressed Concrete	M 204
A 496	Standard Specification for Steel Wire, Deformed, for Concrete Reinforcement	M 225
A 497	Standard Specification for Steel Welded Wire Reinforcement, Deformed, for Concrete	M 221
A 615	Standard Specification for Deformed and Plain Carbon-Steel Bars for Concrete Reinforcement	M 31
A 722	Standard Specification for Uncoated High-Strength Steel Bars for Prestressing Concrete	M 275
A 775	Standard Specification for Epoxy-Coated Steel Reinforcing Bars	M 284
A 82	Standard Specification for Steel Wire, Plain, for Concrete Reinforcement	M 32
A 996	Standard Specification for Rail-Steel and Axle-Steel Deformed Bars for Concrete Reinforcement	M 322
C 1064	Standard Test Method for Temperature of Freshly Mixed Hydraulic-Cement Concrete	WAQTC FOP for T 309
C 1107	Standard Specification for Packaged Dry, Hydraulic-Cement Grout (Nonshrink)	TP 83
C 1240	Standard Specification for Silica Fume Used in Cementitious Mixtures	M 307
C 138	Standard Test Method for Density (Unit Weight), Yield, and Air Content (Gravimetric) of Concrete	WAQTC FOP for T 121
C 143	Standard Test Method for Slump of Hydraulic-Cement Concrete	WAQTC FOP for T 119
C 150	Standard Specification for Portland Cement	M 85
C 171	Standard Specification for Sheet Materials for Curing Concrete	M 171
C 172	Standard Practice for Sampling Freshly Mixed Concrete	WAQTC TM 2
C 192	Standard Practice for Making and Curing Concrete Test Specimens in the Laboratory	R 39

ASTM	Title	WAQTC/AASHTO
C 231	Standard Test Method for Air Content of Freshly Mixed Concrete by the Pressure Method	WAQTC FOP for T 152
C 260	Standard Specification for Air-Entraining Admixtures for Concrete	M 154
C 309	Standard Specification for Liquid Membrane-Forming Compounds for Curing Concrete	M 148
C 31	Standard Practice for Making and Curing Concrete Test Specimens in the Field	WAQTC FOP for R 100
C 33	Standard Specification for Concrete Aggregates	M 6/M 80
C 330	Standard Specification for Lightweight Aggregates for Structural Concrete	M 195
C 39	Standard Test Method for Compressive Strength of Cylindrical Concrete Specimens	T 22
C 494	Standard Specification for Chemical Admixtures for Concrete	M 194
C 595	Standard Specification for Blended Hydraulic Cements	M 240
C 618 REV A	Standard Specification for Coal Fly Ash and Raw or Calcined Natural Pozzolan for Use in Concrete	M 295
C 685	Standard Specification for Concrete Made by Volumetric Batching and Continuous Mixing	M 241
C 881	Standard Specification for Epoxy-Resin-Base Bonding Systems for Concrete	M 235
C 989	Standard Specification for Slag Cement for Use in Concrete and Mortars	M 302
D1557	Standard Test Methods for Laboratory Compaction Characteristics of Soil Using Modified Effort (56,000 ft-lbf/ft ³ (2,700 kN-m/m ³))	WAQTC FOP for T 99/ T 180
D 1751	Standard Specification for Preformed Expansion Joint Filler for Concrete Paving and Structural Construction (Nonextruding and Resilient Bituminous Types)	M 212
D 1752	Standard Specification for Preformed Sponge Rubber Cork and Recycled PVC Expansion Joint Fillers for Concrete Paving and Structural Construction	M 153
D 698	Standard Test Methods for Laboratory Compaction Characteristics of Soil Using Standard Effort (12 400 ft-lbf/ft ³ (600 kN-m/m ³))	WAQTC FOP for T 99/ T 180
D 98	Standard Specification for Calcium Chloride	M 144
M 994	Standard Specification for Preformed Expansion Joint Filler for Concrete (Bituminous Type)	M 33

Rounding and Precision in Materials Test Reporting SP 6

1. Scope

This standard practice provides a procedure for rounding off numbers generated during the process of calculating materials testing results **when a specific test method does not specify rounding procedures.**

2. Calculation Procedures

Follow the rounding rules found in Section **4.7 Degree of Accuracy** of the current *Alaska Construction Manual*.

<https://dot.alaska.gov/stwddes/dcsconst/constructionmanual.shtml>

This page intentionally left blank.

Determination of Outlier Test Results SP 7

1. Scope

This standard practice provides a mechanism for rejecting individual test values that may misrepresent the physical properties of a material lot. The method statistically identifies a non-representative "outlier" and justifies its removal from the remaining test data for the lot.

2. General

1. When a test result is clearly a result of a gross deviation from prescribed sampling or testing procedure, the test result should be discarded, without further analysis. When no direct evidence of sampling and/or testing errors exists, the lot data will be statistically evaluated for the presence of an outlier.
2. An outlying test result will be assumed to be non-characteristic of the overall quality of the material tested. Outlying test results will be excluded from the price adjustment calculation, by either documental evidence or through statistical analysis.

3. Basis of Statistical Criteria For Outliers

All test results in a lot are included in the calculation of the numerical value of a sample criterion (or statistic), which is then compared with a critical value based on the theory of random sampling from a normal distribution to determine whether the doubtful test result is to be retained or rejected. The critical value is that value of the sample criterion that would be exceeded by chance with 5% total probability. This 5% probability is the risk of erroneously rejecting a good observation and is the Department's defined outlier threshold limit.

4. Procedure

1. Calculate the arithmetic mean \bar{x} of all test results for the lot using the following formula:

$$\bar{x} = \frac{\sum X}{n}$$

Where:

- \sum = summation of
- X = individual test value to xn
- n = total number of test values

And where: \bar{x} is rounded to the nearest 0.1 percent for density and all sieve sizes except the 0.075 mm (No. 200) sieve.

\bar{x} is rounded to the nearest 0.01 percent for asphalt content and the 0.075 mm (No. 200) sieve.

2. Calculate sample standard deviation (s) of all test results for the lot using the following formula:

$$s = \sqrt{\frac{n\sum(x^2) - (\sum x)^2}{n(n-1)}}$$

Where:

- s = standard deviation of the lot
- $\sum(x^2)$ = summation of the squares of individual test values.
- $(\sum x)^2$ = square of the summation of the individual test values.

n = total number of test values

3. The lot standard deviation (s) is rounded to the nearest 0.01 for density and all sieve sizes except the 0.075 mm (No. 200) sieve. The lot standard deviation(s) is rounded to the nearest 0.001 for asphalt content and the 0.075 mm (No. 200) sieve.

Note 1: This is the sample standard deviation and not the population (sigma) standard deviation. Many computer spreadsheet programs have formulas for population standard deviation and not sample standard deviation.

4. Calculate the difference between the arithmetic mean (\bar{x}) and the lowest test result (X_L); and between the highest test result (X_H) and the arithmetic mean \bar{x}
5. Calculate test criterion, T_L or T_H , of the test result with the greatest difference from the arithmetic mean (\bar{x}) .
6. If the lowest test result (X_L) has the greatest difference from the arithmetic mean \bar{x} , then T_L is calculated as follows:

$$T_L = \frac{(X_L - \bar{x})}{s}$$

7. If the highest test result (X_H) has the greatest difference from the arithmetic mean (\bar{x}) , then T_H is calculated as follows:

$$T_H = \frac{(X_H - \bar{x})}{s}$$

Determine critical T value from Table 1.

8. If T_L or T_H , whichever is larger, exceeds the critical T value from Table 1, then that test result is an outlier and will be excluded from the price adjustment calculations. If one or more additional test result(s) has the same value as the outlier, then none of the test results will be outliers and all test results will be included in the price adjustment calculations. If T_L and T_H are equal, then neither test result will be an outlier and all test results will be included in the price adjustment calculations.

Note 2: This test method will not be reapplied to identify additional "outliers" based on the new arithmetic mean and sample standard deviations calculated after the "outliers" have been excluded.

Table 1
Critical T Values for a Sample Standard Deviation

Number Of Samples, n	Critical T
3	1.155
4	1.481
5	1.715
6	1.887
7	2.020
8	2.126
9	2.215
10	2.290
11	2.355
12	2.412
13	2.462
14	2.507
15	2.549
16	2.585
17	2.620

5. Example 1

1. Consider the following test results on percent asphalt content:

5.3, 5.6, 5.8, 5.8, 5.9, 5.9, 5.9, 6.0, 6.0 and 6.0

2. Calculate the arithmetic mean (\bar{x}) :

$$(\bar{x}) = \frac{5.3+5.6+5.8+5.8+5.9+5.9+5.9+6.0+6.0+6.0}{10}$$

$$(\bar{x}) = 5.82\%$$

3. Calculate the sample standard deviation:

$$s = \sqrt{\frac{n\sum(x^2) - (\sum x)^2}{n(n-1)}}$$

Where:

$$\sum(x)^2 = 339.16$$

$$(\sum x)^2 = 3,387.24$$

$$n = 10$$

$$s = 0.220$$

4. The difference between the arithmetic mean (\bar{x}) and the lowest test result is:

$$(5.82\% - 5.3\%) = 0.52\%$$

5. The difference between the highest test result and the arithmetic mean (\bar{x}) is:

$$(6.0\% - 5.82\%) = .18\%$$

6. Calculate T_L or T_H . Since the lowest test result (5.3%) had the greatest difference from the arithmetic mean (\bar{x}) it is evaluated to determine if it is an outlier. T_L is calculated as follows:

$$T_L = (5.82\% - 5.3\%) \div 0.220$$

$$T_L = 2.364$$

7. Determine Critical T. From Table 1, the critical T for 10 samples is 2.290. Since $T_L = 2.364$ is greater than 2.290, the test result of 5.3% is an outlier and is excluded from the price adjustment calculations.

6. Example 2

1. Consider the following test result on percent asphalt content:

5.3, 5.8, 5.8, 5.8, 5.9, 5.9, 6.0, 6.0, 6.0 and 6.5

2. Calculate arithmetic mean (\bar{x}):

$$x = \frac{5.3+5.8+5.8+5.8+5.9+5.9+6.0+6.0+6.0+6.5}{10}$$

$$x = 5.90\%$$

3. Calculate sample standard deviation:

$$s = \sqrt{\frac{n \sum (x^2) - (\sum x)^2}{n(n-1)}}$$

Where:

$$\sum(x)^2 = 348.88$$

$$(\sum x)^2 = 3,481.00$$

$$n = 10$$

$$s = 0.294$$

4. The difference between the arithmetic mean x and the lowest test result is:

$$(5.90\% - 5.3\%) = 0.6\%$$

5. The difference between the highest test result and the arithmetic mean (\bar{x}) is:

$$(6.5\% - 5.90\%) = 0.6\%$$

6. Calculate T_L or T_H . Since the lowest test result (5.3%) and the highest test result (6.5%) have the same difference from the arithmetic mean (\bar{x}), both T_L and T_H are calculated.

$$T_L = (5.90\% - 5.3\%) \div 0.294$$

$$T_H = (6.5\% - 5.90\%) \div 0.294$$

$$T_L = T_H = 2.041$$

7. Since T_L and T_H are equal, neither test result is considered to be an outlier and all test results are included in the price adjustment calculation.

This page intentionally left blank.

Standard Practice for Standardization of Pressure Type Air Meter SP 8

1. Scope

This practice covers the standardization of pressure type air meters used to determine the air content of freshly mixed concrete. Standardization procedures are developed to meet AASHTO T 152.

Note: This practice is equipment specific for two models of air meters currently in use by regional/field laboratories.

2. Apparatus

- Press-Ur-Meter (Charles R. Watts Company and Gilson)
- Appropriate standardization vessels for the air meters listed. Standardization vessels will have either be a vessel with an internal volume equal to 5 percent of the volume of the measuring bowl, or a vessel to place into the measuring bowl conforming to Note 1 in AASHTO T 152 and also equal to 5 percent. Regardless of type, the effective volume of the vessel should be checked.

3. Standardization Procedure for the Press-Ur-Meter:

1. Fill the measuring bowl with water.
2. Screw the straight tube into the threaded petcock hole on the underside of the cover. Clamp the cover assembly onto the measuring bowl with the tube extending down into the water.
3. With both petcocks open, add water through the petcock having the tubing extension, until all air is forced out the opposite petcock. Leave both petcocks open.
4. Pump air pressure to 0 percent or to the previous Initial Pressure line. Wait a few seconds for the compressed air to cool to ambient temperature, then stabilize the gauge needle at the assumed initial pressure by pumping up or bleeding off air, as necessary.
5. Close both petcocks and immediately press down on the air release lever exhausting the air into the measuring bowl. Wait a few seconds until the gauge needle is stabilized, tapping lightly on the gauge to keep gauge needle from sticking. If all the air was eliminated and the assumed Initial Pressure line was correct, the gauge should read 0 percent. If two or more tests show a consistent variation from 0 percent in the result, then change the Initial Pressure line to compensate for the variation, or remove the gauge glass and reset the gauge needle to 0 percent by turning the gauge's standardization screw. Use the newly established "Initial Pressure" line for subsequent tests.
6. Screw the curved tube into the outer end of the petcock with the straight tube below and, by pressing on the air release lever and controlling the flow with the petcock lever, fill the 5 percent calibrating vessel (345 ml) level full of water from the measuring bowl.
7. Release the air pressure at the free petcock. Open the other petcock and let the water in the curved pipe run back into the measuring bowl. There is now 5 percent air in the measuring bowl.
8. Pump air pressure to the Initial Pressure as determined in Step 5. Wait a few seconds for the compressed air to cool to ambient temperature and then stabilize the gauge needle at the assumed zero point by pumping up or bleeding off air, as necessary.
9. Close both petcocks and immediately press down on the air release lever exhausting the air into the measuring bowl. Wait a few seconds until the gauge needle is stabilized, tapping lightly on the gauge to keep gauge needle from sticking. If all the air was eliminated and the assumed Initial Pressure line was correct, the gauge should read 5 percent.

10. If two or more consistent tests show that the gauge at 5 percent air reads incorrectly in excess of 0.2 percent, then remove the gauge glass and reset the gauge needle to 5 percent by adjusting the gauge's standardization screw.
11. When the gauge reads correctly at 5 percent, additional water may be withdrawn in the same manner to check results at 10 percent.

4. Standardization Using Internal Standardization Vessel

1. Fill the measuring bowl with water.
2. Clamp the cover assembly onto the measuring bowl.
3. With both petcocks open, add water through one petcock, until all air is forced out the opposite petcock. Leave both petcocks open.
4. Pump air pressure to 0 percent or to the previous Initial Pressure Line. Wait a few seconds for the compressed air to cool to ambient temperature, then stabilize the gauge needle at the assumed zero point by pumping up or bleeding off air, as necessary.
5. Close both petcocks and immediately press down on the air release lever exhausting the air into the measuring bowl. Wait a few seconds until the gauge needle is stabilized, tapping lightly on the gauge to keep gauge needle from sticking. If all the air was eliminated and the assumed Initial Pressure line was correct, the gauge should read 0 percent. If two or more tests show a consistent variation from 0 percent in the result, then change the Initial Pressure line to compensate for the variation, or remove the gauge glass and reset the gauge needle to 0 percent by turning the gauge's standardization screw. Use the newly established "Initial Pressure" line for subsequent tests.
6. Release the pressure and remove the cover assembly.
7. Place the Internal Standardization Vessel into the measuring bowl, replace the cover assembly and refill as in step 3.
8. Pump the air pressure to the Initial Pressure Line allowing a few seconds for the gauge needle to stabilize.
9. Verify there is water standing in both petcocks and then close them.
10. Release to air into the measuring bowl by pressing down on the air release lever. Tap the gauge lightly and when stable, the meter should read 5 percent. If two or more consistent tests show that the gauge at 5 percent air reads incorrectly in excess of 0.2 percent, then remove the gauge glass and reset the gauge needle to 5 percent by adjusting the gauge's standardization screw and re-check.

5. Report

1. Report the results of the standardization as well as noting any adjustments or repairs made.
2. Label the meter with a sticker noting the month and year of the standardization.

Reserved SP 9

This page intentionally left blank.

Worksheets with Examples SP 10

1. Scope

This standard practice includes copies of all the standard forms developed for use on DOT&PF projects. Examples have been included to help clarify their use.

Example Calculations ATM 202

Calculation

Constant Mass for Aggregates:

Calculate constant mass using the following formula:

$$\frac{M_p - M_n}{M_p} \times 100 = \% \text{ Change}$$

Where:

M_p = previous mass measurement

M_n = new mass measurement

Example:

Mass of container: 1232.1 g

Mass of container& sample after first drying cycle: 2637.2 g

Mass, M_p , of possibly dry sample: 2637.2 g - 1232.1 g = 1405.1 g

Mass of container and dry sample after second drying cycle: 2634.1 g

Mass, M_n , of dry sample: 2634.1 g - 1232.1 g = 1402.0 g

$$\frac{1405.1 \text{ g} - 1402.0 \text{ g}}{1405.1 \text{ g}} \times 100 = 0.22\%$$

0.22 percent is not less than 0.10 percent, so continue drying

Mass of container and dry sample after third drying cycle: 2633.0 g

Mass, M_n , of dry sample: 2633.0 g - 1232.1 g = 1400.9 g

$$\frac{1402.0 \text{ g} - 1400.9 \text{ g}}{1402.0 \text{ g}} \times 100 = 0.08\%$$

0.08 percent is less than 0.10 percent, so constant mass has been reached for an aggregate, but continue drying for soil.

Moisture Content Aggregate and Soils:

Calculate the moisture content, as a percent, using the following formula:

$$w = \frac{M_W - M_D}{M_D} \times 100$$

Where:

w = moisture content, percent

M_W = wet mass

M_D = dry mass

Example:

Mass of container: 1232.1 g

Mass of container and wet sample: 2764.7 g

Mass, M_w , of wet sample: 2764.7 g - 1232.1 g = 1532.6 g

Mass of container and dry sample (COOLED): 2633.0 g

Mass, M_d , of dry sample: 2633.0 g - 1232.1 g = 1400.9 g

$$w = \frac{1532.6\text{g} - 1400.9\text{g}}{1400.9\text{g}} \times 100 = \frac{131.7\text{g}}{1400.9\text{g}} \times 100 = 9.39\% \text{ report } 9.4\%$$

Example Calculations ATM 204

Calculate the liquid limit according to Method B as follows:

<u>N</u>	<u>(N/25)^{0.121}</u>	<u>N</u>	<u>(N/25)^{0.121}</u>
22	0.985	26	1.005
23	0.990	27	1.009
24	0.995	28	1.014
25	1.000		

$$LL = (W_N)(N/25)^{0.121}$$

Where:

LL = liquid limit

W_N = moisture content of sample at N blows

N = number of blows

Example:

$$W_N = 16.0\% \text{ and } N = 23$$

$$LL = (16.0)(23/25)^{0.121} = 15.8, \text{ say } 16\%$$

Example Calculations ATM 205

The moisture content is the Plastic Limit (PL). It is advisable to run several trials on the same material to ensure a proper determination of the Plastic Limit of the soil.

The Plasticity Index (PI) of the soil is equal to the difference between the Liquid Limit (LL) and the Plastic Limit (PL).

Example Calculation

Container	Container Mass, g	Container and Wet Soil Mass, g	Wet Soil Mass, g	Container and Dry Soil Mass, g	Dry Soil Mass, g
1	14.44	22.65	8.21	21.45	7.01
2	14.18	23.69	9.51	22.81	8.63

Water Mass, g	Moisture Content	Plastic Limit
1.20	17.1	17
0.88	10.2	10

$$PI = LL - PL$$

Examples: #1

$$LL = 34 \text{ and } PL = 17 \\ PI = 34 - 17 = 17$$

#2

$$LL = 16 \text{ and } PL = 10 \\ PI = 16 - 10 = 6$$

Example Calculations ATM 207

Volume

1b. Calculate the wet density, in kg/m^3 (lb/ft^3), by dividing the wet mass from Step 7 by the appropriate volume from Table 1 or Table 2.

Example – Methods A or C mold:

Wet mass = 1.916 kg (4.22 lb)

$$\frac{1.1916 \text{ kg}}{0.000943 \text{ m}^3} = 2023 \text{ kg/m}^3 \text{ Wet Density}^* \quad \frac{4.22 \text{ lb}}{0.0333 \text{ ft}^3} = 126.7 \text{ lb/ft}^3 \text{ Wet Density}^*$$

* Differences in wet density are due to rounding in the respective calculations.

Measured Volume

1c. Calculate the wet density, in kg/m^3 (lb/ft^3), by dividing the wet mass by the measured volume of the mold (T 19).

Example – Methods A or C mold:

Wet mass = 1.916 kg (4.22 lb)

Measured volume of the mold = 0.000946 m^3 (0.0334 ft^3)

$$\frac{1.1916 \text{ kg}}{0.000946 \text{ m}^3} = 2025 \text{ kg/m}^3 \text{ Wet Density}^* \quad \frac{4.22 \text{ lb}}{0.0334 \text{ ft}^3} = 126.3 \text{ lb/ft}^3 \text{ Wet Density}^*$$

2. Calculate the dry density as follows.

$$\rho_d = \left(\frac{\rho_w}{w + 100} \right) \times 100 \quad \text{or} \quad \rho_d = \frac{\rho_w}{\left(\frac{w}{100} \right) + 1}$$

Where:

ρ_d = Dry density, kg/m^3 (lb/ft^3)

ρ_w = Wet density, kg/m^3 (lb/ft^3)

W = Moisture content, as a percentage

Example:

$\rho_w = 2030 \text{ kg/m}^3$ (126.6 lb/ft^3) and $w = 14.7\%$

$$\rho_d = \left(\frac{2030 \text{ kg/m}^3}{14.7 + 100} \right) \times 100 = 1770 \text{ kg/m}^3 \quad \rho_d = \left(\frac{126.6 \text{ lb/ft}^3}{14.7 + 100} \right) \times 100 = 110.4 \text{ lb/ft}^3$$

or

$$\rho_d = \left(\frac{2030 \text{ kg/m}^3}{\frac{14.7}{100} + 1} \right) = 1770 \text{ kg/m}^3 \quad \rho_d = \left(\frac{126.6 \text{ lb/ft}^3}{\frac{14.7}{100} + 1} \right) = 110.4 \text{ lb/ft}^3$$

Example Calculations ATM 207 Appendix A

Sample Calculations English:

Maximum laboratory dry density (D_f):	140.4 lb/ft ³
Percent coarse particles (P_c):	27%
Percent fine particles (P_f):	73%
Mass per volume of coarse particles (k):	(2.697) (62.4) = 168.3 lb/ft ³

$$D_d = \frac{100 \times D_f \times k}{(D_f \times P_c) + (k \times P_f)} \quad \text{or} \quad D_d = \frac{100}{\frac{P_f}{D_f} + \frac{P_c}{k}}$$

$$D_d = \frac{100 \times 140.4 \text{ lb/ft}^3 \times 168.3 \text{ lb/ft}^3}{(140.4 \text{ lb/ft}^3 \times 27\%) + (168.3 \text{ lb/ft}^3 \times 73\%)}$$

$$\text{or } D_d = \frac{100}{\frac{73\%}{140.4 \text{ lb/ft}^3} + \frac{27\%}{168.3 \text{ lb/ft}^3}}$$

$$D_d = \frac{2,362,932 \text{ lb/ft}^3}{(3790.8 \text{ lb/ft}^3 + 12285.9 \text{ lb/ft}^3)} \quad \text{or} \quad D_d = \frac{100}{0.51994 \text{ lb/ft}^3 + 0.16043 \text{ lb/ft}^3}$$

$$D_d = \frac{2,362,932 \text{ lb/ft}^3}{16,076.7 \text{ lb/ft}^3} \quad \text{or} \quad D_d = \frac{100}{0.68037 \text{ lb/ft}^3}$$

$$D_d = 146.98 \text{ lb/ft}^3 \quad \text{report } 147.0 \text{ lb/ft}^3$$

Example Calculations ATM 304

Method A Sample Calculation

Calculate percent retained on and passing each sieve on the basis of the total mass of the initial dry sample. This will include any material finer than 75 μm (No. 200) that was washed out.

Example:

Dry mass of total sample, before washing: 5168.7 g

Dry mass of sample, after washing out the 75 μm (No. 200) minus: 4911.3 g

Amount of 75 μm (No. 200) minus washed out: 5168.7 g – 4911.3 g = 257.4 g

Gradation on All Sieves

Sieve Size mm (in.)		Individual Mass Retained, g (IMR)	Individual Percent Retained (IPR)	Cumulative Mass Retained, g (CMR)	Cumulative Percent Retained (CPR)	Calc'd Percent Passing (CPP)	Reported Percent Passing* (RPP)
19.0	(3/4)	0	0	0	0.0	100.0	100
12.5	(1/2)	724.7	14.0	724.7	14.0	86.0	86
9.5	(3/8)	619.2	12.0	1343.9	26.0	74.0	74
4.75	(No. 4)	1189.8	23.0	2533.7	49.0	51.0	51
2.36	(No. 8)	877.6	17.0	3411.3	66.0	34.0	34
1.18	(No. 16)	574.8	11.1	3986.1	77.1	22.9	23
0.600	(No. 30)	329.8	6.4	4315.9	83.5	16.5	16
0.300	(No. 50)	228.5	4.4	4544.4	87.9	12.1	12
0.150	(No. 100)	205.7	4.0	4750.1	91.9	8.1	8
0.075	(No. 200)	135.4	2.6	4885.5	94.5	5.5	5.5
Pan		20.4		4905.9			

*Report 75 µm (No. 200) sieve to 0.1 percent. Report all others to 1 percent.

Check sum:

$$\frac{4911.3 \text{ g} - 4905.9 \text{ g}}{4911.3 \text{ g}} \times 100 = 0.1\%$$

This is less than 0.3 percent therefore the results can be used for acceptance purposes.

Percent Retained:

9.5 mm (3/8) sieve:

$$\frac{619.2 \text{ g}}{5168.7 \text{ g}} \times 100 = 12.0\% \quad \text{or} \quad \frac{1343.9 \text{ g}}{5168.7 \text{ g}} \times 100 = 26.0\%$$

Percent Passing (Calculated):

$$9.5 \text{ mm (3/8) sieve: } 86.0\% - 12.0\% = 74.0\% \quad \text{or} \quad 100\% - 26.0\% = 74.0\%$$

Method B Sample Calculation

Sample calculation for percent retained and percent passing each sieve in accordance with Method B when the previously washed 4.75mm (No. 4) minus material is split:

Example:

Dry mass of total sample, before washing: 3214.0 g

Dry mass of sample, after washing out the 75 µm (No. 200) minus: 3085.1 g

Amount of 75 µm (No. 200) minus washed out: 3214.0 g – 3085.1 g = 128.9 g

Gradation on Coarse Sieves

Sieve Size		Individual Mass Retained, g (IMR)	Individual Percent Retained (IPR)	Cumulative Mass Retained, g (CMR)	Cumulative Percent Retained (CPR)	Calculated Percent Passing (CPP)
mm	(in.)					
16.0	(5/8)	0	0	0	0	100
12.5	(1/2)	161.1	5.0	161.1	5.0	95.0
9.50	(3/8)	481.4	15.0	642.5	20.0	80.0
4.75	(No. 4)	475.8	14.8	1118.3	34.8	65.2
Pan		1966.7 (M ₁)		3085.0		

Coarse check sum:

$$\frac{3085.1 \text{ g} - 3085.0 \text{ g}}{3085.1 \text{ g}} \times 100 = 0.0\%$$

This is less than 0.3 percent therefore the results can be used for acceptance purposes.

Note 5: The pan mass determined in the laboratory (M₁) and the calculated mass (3085.1 – 1118.3 = 1966.7) should be the same if no material was lost.

The pan (1966.7 g) was reduced in accordance with the FOP for AASHTO T 248, so that at least 500 g are available. In this case, the mass determined was **512.8 g**. This is M₂.

In order to account for the fact that only a portion of the minus 4.75mm (No. 4) material was sieved, the mass of material retained on the smaller sieves is adjusted by a factor equal to M₁/M₂. The factor determined from M₁/M₂ must be carried to three decimal places. Both the individual mass retained and cumulative mass retained formulas are shown.

Individual Mass Retained:

M₁ = total mass of the minus 4.75mm (No. 4) before reducing.

M₂ = mass before sieving from the reduced portion of the minus 4.75 mm (No. 4).

$$\frac{M_1}{M_2} = \frac{1,966 \text{ g}}{512.8 \text{ g}} = 3.835$$

Each “individual mass retained” on the fine sieves must be multiplied by this adjustment factor.

For example, the overall mass retained on the 2.00mm (No. 10) sieve is:

3.835 × 207.1 g = 794.2 g, as shown in the following table:

Final Gradation on All Sieves

Calculation by Individual Mass

Sieve Size		Individual Mass Retained, g (IMR)	Adjusted Individual Mass Retained (AIMR)	Individual Percent Retained (IPR)	Calc'd Percent Passing (CPP)	Reported Percent Passing* (RPP)
mm	(in.)					
16.0	(5/8)	0	0	0.0	100.0	100
12.5	(1/2)	161.1	161.1	5.0	95.0	95
9.5	(3/8)	481.4	481.4	15.0	80.0	80
4.75	(No. 4)	475.8	475.8	14.8	65.2	65
2.0	(No. 10)	207.1 × 3.835	794.2	24.7	40.5	40
0.425	(No. 40)	187.9 × 3.835	720.6	22.4	18.1	18

Sieve Size mm (in.)		Individual Mass Retained, g (IMR)	Adjusted Individual Mass Retained (AIMR)	Individual Percent Retained (IPR)	Calc'd Percent Passing (CPP)	Reported Percent Passing* (RPP)
0.210	(No. 80)	59.9 × 3.835	229.7	7.1	11.0	11
0.075	(No. 200)	49.1 × 3.835	188.3	5.9	5.1	5.1
Pan		7.8 × 3.835	29.9			
Dry mass of total sample, before washing: 3214.0 g						

*Report 75 µm (No. 200) sieve to 0.1 percent. Report all others to 1 percent.

Fine check sum:

$$\frac{512.8 \text{ g} - 511.8 \text{ g}}{512.8 \text{ g}} \times 100 = 0.2\%$$

This is less than 0.3 percent therefore the results can be used for acceptance purposes.

For Percent Passing (Calculated) see "Calculation" under Method A.

Cumulative Mass Retained:

M₁ = mass of the minus 4.75 mm (No. 4) before split

M₂ = mass before sieving of the split of the minus 4.75 mm (No. 4)

$$\frac{M_1}{M_2} = \frac{1,966 \text{ g}}{512.8 \text{ g}} = 3.835$$

Each "cumulative mass retained" on the fine sieves must be multiplied by this adjustment factor then the cumulative mass of plus 4.75 mm (No. 4) portion of sample is added to equal the adjusted cumulative mass retained .

For example, the adjusted cumulative mass retained on the 0.425 mm (No. 40) sieve is:

$$3.835 \times 395.0 \text{ g} = 1514.8 \text{ g}$$

1514.8 + 1118.3 g = 2633.1: "Total Cumulative Mass Retained" as shown in the following table:

Final Gradation on All Sieves

Calculation by Cumulative Mass

Sieve Size mm (in.)		Cumulative Mass Retained, g (CMR)	Adjusted Cumulative Mass Retained, g (ACMR)	Total Cumulative Mass Retnd., g (TCMR)	Cumulative Percent Retnd. (CPR)	Calc'd Percent Passing (CPP)	Reported Percent Passing* (RPP)
16.0	(5/8)	0		0	0.0	100.0	100
12.5	(1/2)	161.1		161.1	5.0	95.0	95
9.5	(3/8)	642.5		642.5	20.0	80.0	80
4.75	(No. 4)	1118.3		1118.3	34.8	65.2	65
2.0	(No. 10)	207.1 × 3.835	794.2 + 1118.3	1912.5	59.5	40.5	40
0.425	(No. 40)	395.0 × 3.835	1514.8 + 1118.3	2633.1	81.9	18.1	18
0.210	(No. 80)	454.9 × 3.835	1744.5 + 1118.3	2862.8	89.1	10.9	11
0.075	(No. 200)	504.0 × 3.835	1932.8 + 1118.3	3051.1	94.9	5.1	5.1
Pan		511.8 × 3.835	1962.8 + 1118.3	3081.1			

*Report 75 µm (No. 200) sieve to 0.1 percent. Report all others to 1 percent.

Fine check sum:

$$\frac{512.8 \text{ g} - 511.8 \text{ g}}{512.8 \text{ g}} \times 100 = 0.2\%$$

This is less than 0.3 percent therefore the results can be used for acceptance purposes.

For Percent Passing (Calculated) see “Calculation” under Method A.

Method C Sample Calculation

Sample calculation for percent retained and percent passing each sieve in accordance with Method C when the minus 4.75mm (No. 4) material is reduced and then washed:

Dry Mass of total sample:	3304.5 g
Dry Mass of minus 4.75mm (No. 4) reduced portion before wash, M _{#4} :	527.6
Dry Mass of minus 4.75mm (No. 4) reduced portion after wash:	495.3

Gradation on Coarse Sieves

Sieve Size mm (in.)		Cumulative Mass Retained, g (CMR)	Calc'd Percent Retained (CPR)	Calc'd Percent Passing (CPP)	Reported Percent Passing* (RPP)
16.0	(5/8)	0	0.0	100.0	100
12.5	(1/2)	125.9	3.8	96.2	96
9.50	(3/8)	604.1	18.3	81.7	82
4.75	(No. 4)	1295.6	39.2	60.8	61
Pan		2008.9			
Total Dry Sample = 3304.5					

Coarse check sum:

$$\frac{3304.5 \text{ g} - 3304.5 \text{ g}}{3304.5 \text{ g}} \times 100 = 0.0\%$$

This is less than 0.3 percent therefore the results can be used for acceptance purposes.

The pan (2008.9 g) was reduced in accordance with the FOP for AASHTO T 248, so that at least 500 g are available. In this case, the mass determined was M_{#4} = **527.6 g**.

Final Gradation on All Sieves

Calculation by Cumulative Mass

Sieve Size mm (in.)		Cumulative Mass Retained, g (CMR _{#4})	Cumulative Percent Retained _{#4} (CPR _{#4})	Calc'd Percent Passing _{#4} (CPP _{#4})	Calc'd Percent Passing (CPP)	Reported Percent Passing* (RPP)
16.0	(5/8)	0	0.0		100.0	100
12.5	(1/2)	125.9	3.8		96.2	96
9.5	(3/8)	604.1	18.3		81.7	82
4.75	(No. 4)	1295.6	39.2		60.8	61
2.0	(No. 10)	194.3	36.8	63.2	38.4	38

0.425	(No. 40)	365.6	69.3	30.7	18.7	19
0.210	(No. 80)	430.8	81.7	18.3	11.1	11
0.075	(No. 200)	484.4	91.8	8.2	5.0	5.0
Pan		495.1				
Dry mass (M) of minus 4.75 mm (No. 4) sample, before washing: 527.6 g						
Dry mass of minus 4.75 mm (No. 4) sample, after washing: 495.3 g						

*Report 75 μm (No. 200) sieve to 0.1 percent. Report all others to 1 percent

Fine check sum:

$$\frac{495.3 \text{ g} - 495.1 \text{ g}}{495.3 \text{ g}} \times 100 = 0.04\%$$

This is less than 0.3 percent therefore the results can be used for acceptance purposes.

Also note that for minus No. 4 material using this method that:

$$CPP = \frac{CPP_{\#4} \times (M_{\#4} - CMR_{\#4})}{M_{\#4}}$$

Example Calculations ATM 305

Example:

F = 632.6 g, Q = 97.6 g, N = 352.6 g

% Q =

$$\frac{97.6 \text{ g}}{632.6 \text{ g} + 97.6 \text{ g} + 352.6 \text{ g}} \times 100 = 9.0\% \quad \%Q = \mathbf{9\%}$$

Calculate the mass percentage of fractured faces to the nearest 1 percent using the following formula:

$$P = \frac{\frac{Q}{2} + F}{F + Q + N} \times 100$$

Where:

P = Percent of fracture

F = Mass of fractured particles

Q = Mass of questionable or borderline particles

N = Mass of unfractured particles

Example:

F = 632.6 g, Q = 97.6 g, N = 352.6 g

$$P = \frac{\frac{97.6 \text{ g}}{2} + 632.6 \text{ g}}{632.6 \text{ g} + 97.6 \text{ g} + 352.6 \text{ g}} \times 100 \quad \mathbf{P = 63\%}$$

Example Calculations ATM 306

Calculate the cumulative percent retained of each size group flat and elongated (F&E) in relation to the total plus 4.75 mm (No. 4).

$$\text{F\&E Group CPR} = (\text{CPR} \div \#4 \text{ CPR}) \times 100$$

Example:

CPR=35%, #4 CPR=58%

$$\text{Group CPR} = (35\% \div 58\%) \times 100 \quad \text{F\&E Group CPR} = 60\%$$

Calculate the individual percent retained of each group:

$$\text{F\&E Group Individual Percent Retained (IPR)} = \text{F\&E Group CPR} - \text{Next Larger Group CPR}$$

Example:

F&E Group CPR=100%, Next Larger Group CPR=60%

$$\text{F\&E Group Individual Percent Retained (IPR)} = 100\% - 60\%, \quad \text{IPR} = 40\%$$

Calculate the percent flat and elongated for each size group.

$$\% \text{ F\&E for Size Group} = [(\text{Mass F\&E Size Group}) / (\text{Size Group Mass})] \times 100$$

Example:

Mass F&E Size Group=3.3g, Size Group Mass=104.9g

$$\% \text{ F\&E for Size Group (B)} = [(104.9) / (3.3)] \times 100 \quad \text{B} = 3.1\%$$

Calculate the weighted percent for each size to 0.1%.

$$\text{Weighted \% F\&E Size Group} = (\% \text{ F\&E for Size Group} \times \text{F\&E Group IPR}) \div 100$$

Example:

% F&E for Size Group=3.1%, F&E Group IPR=40%

$$\text{Weighted \% F\&E Size Group} = (3.1\% \times 40\%) \div 100 \quad \text{Weighted \% F\&E Size Group} = 1.2\%$$

Calculate the total percentage of F&E by determining the sum of all the weighted % F&E for Size Groups.

$$\text{Total Weighted \% F\&E} = 1.1\% + 1.2\% \quad \text{Total Weighted \% F\&E} = 2\%$$

Example Calculations ATM 308

Perform calculations and determine values using the appropriate formula below. In these formulas, A = oven dry mass, B = SSD mass, and C = weight in water.

Bulk specific gravity (G_{sb})

$$G_{sb} = \frac{A}{B - C}$$

Bulk specific gravity, SSD ($G_{sb}SSD$)

$$G_{sb}SSD = \frac{B}{B - C}$$

Apparent specific gravity (G_{sa})

$$G_{sa} = \frac{A}{A - C}$$

Absorption

$$\text{Absorption} = \frac{B - A}{A} \times 100$$

Sample	A	B	C	B - C	A - C	B - A
1	2030.9	2044.9	1304.3	740.6	726.6	14.0
2	1820.0	1832.5	1168.1	664.4	651.9	12.5
3	2035.2	2049.4	1303.9	745.5	731.3	14.2

Sample	G_{sb}	G_{sb} SSD	G_{sa}	Absorption
1	2.742	2.761	2.795	0.7
2	2.739	2.758	2.792	0.7
3	2.730	2.749	2.783	0.7

These calculations demonstrate the relationship between G_{sb} , G_{sb} SSD, and G_{sa} . G_{sb} is always lowest, since the volume includes voids permeable to water. G_{sb} SSD is always intermediate. G_{sa} is always highest, since the volume does not include voids permeable to water. When running this test, check to make sure the values calculated make sense in relation to one another.

Example Calculations ATM 406

Calculate the asphalt binder content of the sample as follows:

$$P_b = \frac{M_i - M_f}{M_i} \times 100 - C_f - MC$$

Where:

- P_b = the corrected asphalt binder content as a percent by mass of the HMA sample
- M_f = the final mass of aggregate remaining after ignition
- M_i = the initial mass of the HMA sample prior to ignition
- C_f = correction factor as a percent by mass of the HMA sample
- MC = moisture content of the companion HMA sample, percent, as determined by the FOP for AASHTO T 329 (if the specimen was oven-dried prior to initiating the procedure, MC=0).

Example

Correction Factor	=	0.42
Moisture Content	=	0.04
Initial Mass of Sample and Basket	=	5292.7
Mass of Basket Assembly	=	2931.5
M_i	=	2361.2
Total Mass after First ignition + basket	=	5154.4

Sample Mass after First ignition = 2222.9

Sample Mass after additional 15 min ignition = 2222.7

$$\frac{2222.9 - 2222.7}{2222.9} \times 100 = 0.009$$

Not greater than 0.01 percent, so M_f = 2222.7

$$P_b = \frac{2361.2 - 2222.7}{2361.2} \times 100 - 0.42 - 0.04 = 5.41\%$$

$P_b = 5.41\%$

Example Calculations ATM 407

Constant Mass:

Calculate constant mass using the following formula:

$$\%Change = \frac{M_p - M_n}{M_p} \times 100$$

Where:

M_p = previous mass measurement

M_n = new mass measurement

Example:

Mass of container: 232.6 g

Mass of container and sample after first drying cycle: 1361.8 g

Mass, M_p , of possibly dry sample: 1361.8 g – 232.6 g = 1129.2 g

Mass of container and possibly dry sample after second drying cycle: 1360.4 g

Mass, M_n , of possibly dry sample: 1360.4 g – 232.6 g = 1127.8 g

$$\frac{1129.2 \text{ g} - 1127.8 \text{ g}}{1129.2 \text{ g}} \times 100 = 0.12\%$$

0.12 percent is not less than 0.05 percent, so continue drying the sample.

Mass of container and possibly dry sample after third drying cycle: 1359.9 g

Mass, M_n , of dry sample: 1359.9g – 232.6g = 1127.3g

$$\frac{1127.8 \text{ g} - 1127.3 \text{ g}}{1127.8 \text{ g}} \times 100 = 0.04\%$$

0.04 percent is less than 0.05 percent, so constant mass has been reached.

Moisture Content:

Calculate the moisture content, as a percent, using the following formula.

$$\text{Moisture Content} = \frac{M_i - M_f}{M_f} \times 100$$

Where:

M_i = initial, moist mass

M_f = final, dry mass

Example:

$$M_i = 1134.9 \text{ g}$$

$$M_f = 1127.3 \text{ g}$$

$$\text{Moisture Content} = \frac{1134.9 \text{ g} - 1127.3 \text{ g}}{1127.3 \text{ g}} \times 100 = 0.674, \text{ say } 0.67\%$$

Example Calculations ATM 408

Using the aggregate sample obtained from the FOP for AASHTO T 308, determine and record the mass of the sample to 0.1 g (M). This mass shall agree with the mass of the aggregate remaining after ignition (M_f from T 308) within 0.10 percent. If the variation exceeds 0.10 percent the results cannot be used for acceptance.

$$\frac{M_{f(T308)} - M_{(T30)}}{M_{f(T308)}} \times 100$$

Where:

$$M_{(T30)} = 2422.3 \text{ g}$$

$$M_{f(T308)} = 2422.5 \text{ g}$$

$$\frac{2422.5 \text{ g} - 2422.3 \text{ g}}{2422.5 \text{ g}} \times 100 = 0.01\%$$

CHECK SUM

Total mass of material after sieving must agree with mass before sieving to within 0.2 percent.

$$\frac{\text{dry mass after washing} - \text{total mass after sieving}}{\text{dry mass after washing}} \times 100$$

PERCENT RETAINED:

Where:

IPR = Individual Percent Retained

CPR = Cumulative Percent Retained

M = Total Dry Sample mass before washing

IMR = Individual Mass Retained

CMR = Cumulative Mass Retained

$$\text{IPR} = \frac{\text{IMR}}{M} \times 100 \quad \text{OR} \quad \text{CPR} = \frac{\text{CMR}}{M} \times 100$$

PERCENT PASSING and REPORTED PERCENT PASSING:

Where:

PP = Calculated Percent Passing

PCP = Previous Calculated Percent Passing

RPP = Reported Percent Passing

$$PP = PCP - IPR \quad \text{OR} \quad PP = 100 - CPR$$

$$RPP = PP + \text{Aggregate Correction Factor}$$

Example:

Dry mass of total sample, before washing (M): 2422.3 g

Dry mass of sample, after washing out the 75 μm (No. 200) minus: 2296.2 g

Amount of 75 μm (No. 200) minus washed out: 2422.3 g – 2296.2g = 126.1 g

Percent Retained 75 μm / No. 200:

$$\frac{63.5 \text{ g}}{2422.3 \text{ g}} \times 100 = 2.6\% \quad \text{or} \quad \frac{2289.6 \text{ g}}{2422.3 \text{ g}} \times 100 = 94.5\%$$

Percent Passing: 8.1% – 2.6% = 5.5% or 100% – 94.5% = 5.5%

Reported Percent Passing: 5.5% + (-0.6%) = 4.9%

Gradation on All Screens

Sieve Size		Mass Retained (g) (MR)	Percent Retained (PR)	Cumulative Mass Retained (g) (CMR)	Cumulative Percent Retained (CPR)	Calc'd Percent Passing (PP)	Agg. Corr. Factor from T 308 (ACF)	Reported Percent Passing (RPP)
mm	(in.)							
19.0	(3/4)	0.0		0.0	0	100.0		100
12.5	(1/2)	346.9	14.3	346.9	14.3	85.7		86
9.5	(3/8)	207.8	8.6	554.7	22.9	77.1		77
4.75	(No. 4)	625.4	25.8	1180.1	48.7	51.3		51
2.36	(No. 8)	416.2	17.2	1596.3	65.9	34.1		34
01.18	(No. 16)	274.2	11.3	1870.5	77.2	22.8		23
0.600	(No. 30)	152.1	6.3	2022.6	83.5	16.5		16
0.300	(No. 50)	107.1	4.4	2129.7	87.9	12.1		12
0.150	(No. 100)	96.4	4.0	2226.1	91.9	8.1		8
75 μm	(No. 200)	63.5	2.6	2289.6	94.5	5.5	-0.6	4.9
Pan		5.7		2295.3				

Check sum:

$$\frac{2296.2 \text{ g} - 2295.3 \text{ g}}{2296.2 \text{ g}} \times 100 = 0.04\%$$

This is less than 0.2 percent therefore the results can be used for acceptance purposes.

Example Calculations ATM 409

Flask Procedure

$$G_{mm} = \frac{A}{A + D - E} \times R \quad \text{or} \quad G_{mm} = \frac{A}{A_{SSD} + D - E} \times R$$

(for mixtures containing uncoated materials)

Where:

A = Mass of dry sample in air, g

A_{SSD} = Mass of saturated surface-dry sample in air, g

D = Mass of flask filled with water at 25°C (77°F), g, determined during the Standardization of Flask procedure

E = Mass of flask filled with water and the test sample at test temperature, g

R = Factor from Table 2 to correct the density of water – use when a test temperature is outside 25 ±1°C (77 ±2°F)

Example (in which two increments of a large sample are averaged):

Increment 1	Increment 2
A = 2200.3 g	A = 1960.2 g
D = 7502.5 g	D = 7525.5 g
E = 8812.3 g	E = 8690.8 g
Temperature = 26.2°C	Temperature = 25.0°C

$$G_{mm_1} = \frac{2200.3 \text{ g}}{2200.3 \text{ g} + 7502.5 \text{ g} - 8812.3 \text{ g}} \times 0.99968 = 2.470$$

$$G_{mm_2} = \frac{1960.2 \text{ g}}{1960.2 \text{ g} + 7525.5 \text{ g} - 8690.8 \text{ g}} \times 1.00000 = 2.466$$

Allowable variation is: 0.014

2.470 - 2.466 = 0.004, which is < 0.014, so they can be averaged.

Average

$$2.470 - 2.466 = 0.004 \quad 0.004 \div 2 = 0.002 \quad 0.002 + 2.466 = 2.468$$

$$\text{Or } 2.470 + 2.466 = 4.936 \quad 4.936 \div 2 = \mathbf{2.468}$$

Example Calculations ATM 409

Calculations - Method A (Suspension)

$$G_{mb} = \frac{A}{B - C}$$

Where:

A = Mass of dry specimen in air, g

B = Mass of SSD specimen in air, g

C = Weight of specimen in water at $25 \pm 1^\circ\text{C}$ ($77 \pm 1.8^\circ\text{F}$), g

$$\text{Percent Water Absorbed (by volume)} = \frac{B - A}{B - C} \times 100$$

Example:

$$G_{mb} = \frac{4833.6 \text{ g}}{4842.4 \text{ g} - 2881.3 \text{ g}} = 2.465$$

$$\% \text{ Water Absorbed (by volume)} = \frac{4842.4 \text{ g} - 4833.6 \text{ g}}{4842.4 \text{ g} - 2881.3 \text{ g}} \times 100 = 0.4\%$$

Example Calculations ATM 504

- **Density** – Calculate the net mass, M_m , of the concrete in the measure by subtracting the mass of the measure from the gross mass of the measure plus the concrete. Calculate the density, W , by dividing the net mass, M_m , by the volume, V_m , of the measure as shown below.

$$W = \frac{M_m}{V_m}$$

$$\text{Example: } W = \frac{36.06 \text{ lb}}{0.2494 \text{ ft}^3} = 144.6 \text{ lb/ft}^3$$

- **Yield** – Calculate the yield, Y , or volume of concrete produced per batch, by dividing the total mass of the batch, W_1 , by the density, W , of the concrete as shown below.

$$Y = \frac{W_1}{W} \quad \text{Example: } Y = \frac{3978 \text{ lb}}{27 \times 144.6 \text{ lb/ft}^3} = 1.02 \text{ yd}^3$$

Note 5: The total mass, W_1 , includes the masses of the cement, water, and aggregates in the concrete.

- **Cement Content** – Calculate the actual cement content, N , by dividing the mass of the cement, N_t , by the yield, Y , as shown below.

Note 6: Specifications may require Portland cement content and cementitious materials content

$$N = \frac{N_t}{Y} \quad \text{Example: } N = \frac{602 \text{ lb}}{1.02 \text{ yd}^3} = 590 \text{ lb/yd}^3$$

- **Water Content** – Calculate the mass of water in a batch of concrete by summing the:
 - water added at batch plant
 - water added in transit
 - water added at jobsite
 - free water on coarse aggregate
 - free water on fine aggregate
 - liquid admixtures (if the agency requires this)

This information is obtained from concrete batch tickets collected from the driver. Use the following conversion factors.

To Convert From	To	Multiply By
Liters, L	Kilograms, kg	1.0
Gallons, gal	Kilograms, kg	3.785
Gallons, gal	Pounds, lb	8.34
Milliliters, mL	Kilograms, kg	0.001
Ounces, oz	Milliliters, mL	28.4
Ounces, oz	Kilograms, kg	0.0284
Ounces, oz	Pounds, lb	0.0625
Pounds, lb	Kilograms, kg	0.4536

Calculate the mass of free water on aggregate as follows:

$$\text{Free Water Mass} = \text{Total Aggregate Mass} - \frac{\text{Total Aggregate Mass}}{1 + (\text{Free Water Percentage}/100)}$$

Example:

Total Aggregate Mass = 7804 lb

Free Water Percentage = 1.7*

* To determine Free Water percentage:

Total moisture content of the aggregates – absorbed moisture = Free Water

$$\text{Free Water Mass} = 7804 \text{ lb} - \frac{7804 \text{ lb}}{1 + (1.7\%/100)}$$

Example for actual water content:

Water added at batch plant = 79 gal

Water added in transit =

Water added at jobsite = $\frac{11 \text{ gal}}{90 \text{ gal}} = 751 \text{ lb}$

Coarse aggregate: 7804 lbs @ 1.7% free water

Fine aggregate: 5489 lb @ 5.9% free water

$$\text{CA Free Water} = 7804 \text{ lb} - \frac{7804 \text{ lb}}{1 + (1.7\%/100)} = 130 \text{ lb}$$

$$\text{FA Free Water} = 5489 \text{ lb} - \frac{5489 \text{ lb}}{1 + (5.9\%/100)} = 306 \text{ lb}$$

Mass of water in batch = 751 lb + 130 lb + 306 lb = 1187 lb

Water/Cement Ratio – Calculate the water/cement ratio by dividing the mass of water in a batch of concrete by the mass of cementitious material in the batch. The masses of the cementitious materials are obtained from concrete batch tickets collected from the driver.

Example:

Cement: 2094 lb

Fly Ash: 397 lb

Water: 1187 lb

$$W/C = \frac{1187 \text{ lb}}{2094 \text{ lb} + 397 \text{ lb}} = 0.476$$

Report 0.48



STATE OF ALASKA
DOT & PF

FOP for T 180 Modified Proctor
FIELD WORKSHEET

Acceptance Verification Info. IA QC

Sample No: _____

Project Name: _____

Federal No: _____

AKSAS No: _____

Material: _____

Source: _____

Item No: _____

Location: _____

Sampled by / Qualification No: _____

Date: _____

Quantity Represented: _____

Standard Density — Modified Proctor — WAQTC FOP for T 180							METHOD: D	Gradation, % Pass	
COMPACTION TEST		1	2	3	4	5	6	3" / 75mm	
A	Mass of Mold							2" / 50mm	
B	Mass of Mold + Wet Soil							1/4" / 37.5mm	
M	Mass of Wet Sample B - A							1" / 25mm	
MOISTURE CONTENT — WAQTC FOP for T 255 / T 265							$W = [(M_w - MD) / MD] \times 100$		3/4" / 19mm
C	Container							1/2" / 12.5mm	
D	Container + Moist Sample							3/8" / 9.5mm	
M_w	Moist sample D - C							#4 / 4.75mm	
E	Container + Dry Sample							#8 / 2.36mm	
MD	Dry Sample E - C							#16 / 1.18mm	
W	Moisture Content, %							#30 / .600mm	
P_w	Wet Density							#50 / .300mm	
P_d	Dry Density							100 / .150mm	
								200 / .075mm	

ZAV Curve Calculations: $W_s = \frac{(62.4)(G_{sa}) - (Y_d)}{(Y_d)(G_{sa})} \times 100$

Assumed G_{sa}: (if no T 85) _____

W_s % Water Content for complete saturation

1 _____ 2 _____

Dry Density (Y_d) Input for ZAV Curve:

1 _____ 2 _____

V Mold Volume = _____

P_w Wet Density = (M ÷ V)

P_d Dry Density = P_w / [1 + (W / 100)]

SPECIFIC GRAVITY — WAQTC FOP for T 85	
b	SSD Aggregate Mass
c	Aggregate Weight in Water
a	Dry Aggregate Mass
G_{sb}	BULK Specific Gravity = a / (b - c)
	SSD Specific Gravity = b / (b - c)
G_{sa}	Apparent Specific Gravity = a / (a - c)
	Absorption = [(b - a) / a] x 100

MAXIMUM DENSITY (0.1 lb/ft³ or 1 kg/ft³) _____

OPTIMUM MOISTURE (0.1%) _____

Remarks: _____

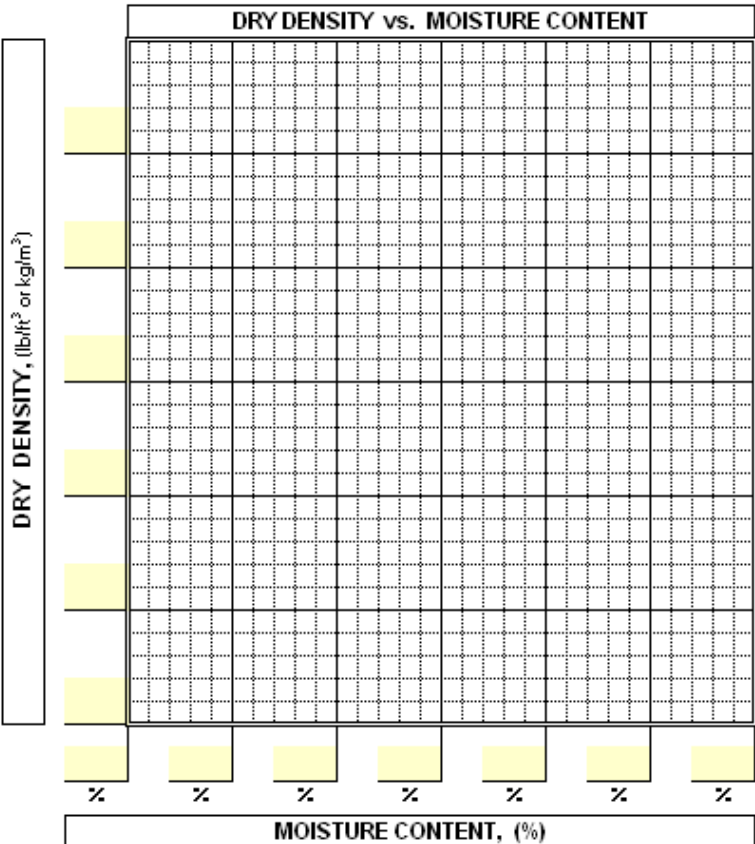

Tested by / Date: _____

Checked by / Date: _____



STATE OF ALASKA
DOT & PF

FOP for T 180 Modified Proctor
FIELD WORKSHEET

Acceptance Verification Info. IA QC

Sample No: BC-SD-1

Project Name: Alaska Highway, MP 1267-1314 Rehabilitation

Federal No: HHE-0A4-3(19)

AKSAS No: 63485

Material: Base Course, D-1

Source: MS-62-2-005-5

Item No: 301(1)

Location: MP 1280, Alaska Highway

Sampled by / Qualification No: J. Groves / #365

Date: 07/24/08

Quantity Represented: Source

Standard Density — Modified Proctor — WAQTC FOP for T 180						METHOD: D	Gradation, % Pass	
COMPACTION TEST		1	2	3	4	5	6	
A	Mass of Mold	12.67	12.67	12.67	12.67	12.67		3" / 75mm
B	Mass of Mold + Wet Soil	23.26	23.51	23.68	23.65	23.64		2" / 50mm
M	Mass of Wet Sample B - A	10.59	10.84	11.01	10.98	10.97		1/4" / 37.5mm
MOISTURE CONTENT — WAQTC FOP for T 255 / T 265						$W = [(M_w - M_D) / M_D] \times 100$		3/4" / 19mm
C	Container	1620.5	1700.5	1670.2	1426.0	1692.3		1/2" / 12.5mm
D	Container + Moist Sample	2636.0	2710.5	2692.3	2438.7	2703.5		3/8" / 9.5mm
M _w	Moist sample D - C	1015.5	1010.0	1022.1	1012.7	1011.2		#4 / 4.75mm
E	Container + Dry Sample	2604.3	2674.9	2651.5	2392.0	2649.2		#8 / 2.36mm
M _D	Dry Sample E - C	983.8	974.4	981.3	966.0	956.9		#16 / 1.18mm
W	Moisture Content, %	3.2	3.7	4.2	4.8	5.7		#30 / .600mm
P _w	Wet Density	141.0	144.3	146.6	146.2	146.1		#50 / .300mm
P _d	Dry Density	136.6	139.2	140.7	139.5	138.2		100 / .150mm
								200 / .075mm

ZAV Curve Calculations: $W_s = \frac{(62.4)(G_{sa}) - (Y_d)}{(Y_d)(G_{sa})} \times 100$

Assumed G_{sa}: (if no T 85)

1 2

Dry Density (Y_d) Input for ZAV Curve:

136.6 140.7

W_s % Water Content for complete saturation

1 11.2 2 9.8

V Mold Volume = 0.0751

P_w Wet Density = (M ÷ V)

P_d Dry Density = P_w / [1 + (W / 100)]

SPECIFIC GRAVITY — WAQTC FOP for T 85

b	SSD Aggregate Mass	2784.3
c	Aggregate Weight in Water	1810.7
a	Dry Aggregate Mass	2765.0
G _{sb}	BULK Specific Gravity = a / (b - c)	2.840
	SSD Specific Gravity = b / (b - c)	2.860
G _{sa}	Apparent Specific Gravity = a / (a - c)	2.897
	Absorption = [(b - a) / a] x 100	0.7

DRY DENSITY, (lb/ft³ or kg/m³)

DRY DENSITY vs. MOISTURE CONTENT

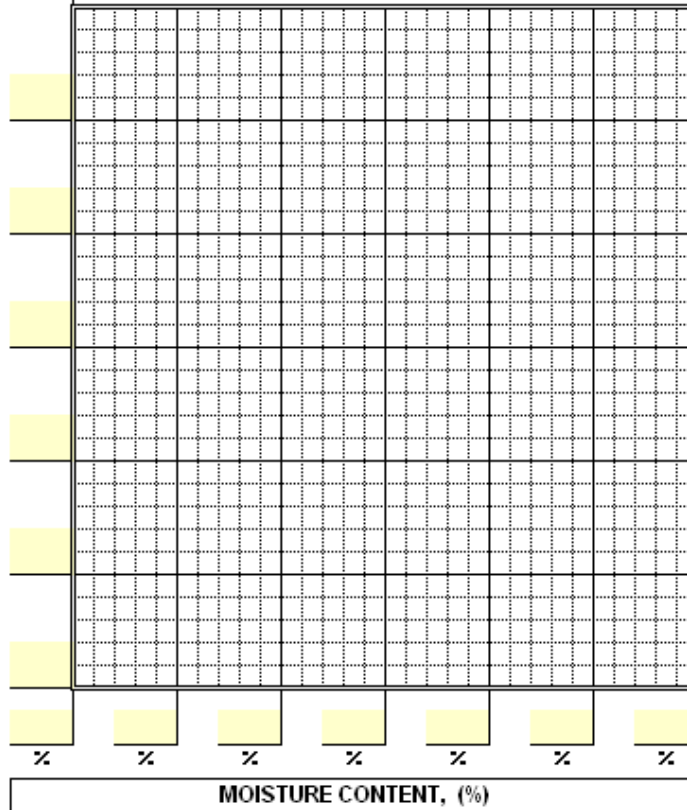

MAXIMUM DENSITY (0.1 lb/ft ³ or 1 kg/m ³)	
OPTIMUM MOISTURE (0.1%)	

Remarks:

Tested by / Date:

Checked by / Date:



**STATE OF ALASKA
DOT & PF
Construction**

ATM 213

WAQTC FOP for AASHTO T 310
FIELD WORKSHEET (METHOD A)

Acceptance Information Assurance

Project Name: _____
State No: _____ 2005
Material: _____ Source _____
Item No. _____ Spec. _____ Gauge Serial No. _____

FIELD DENSITY TEST NUMBER								
STATION								
C/L REFERENCE								
GRADE REFERENCE								
QUANTITY REPRESENTED								
DATE TESTED								
		<input type="checkbox"/> AASHTO T 180	<input type="checkbox"/> ASTM D 1557	<input type="checkbox"/> ATM T-12				
STANDARD DENSITY BY:								
Lab Number								
(A) Standard Density (Maximum Lab)								
Optimum Moisture								
(B) Bulk Specific Gravity								
DENSITY DETERMINATION								
Probe Depth	Reading #1	Reading#2	Reading #1	Reading #2	Reading #1	Reading#2	Reading #1	Reading#2
Wet Density, lbm/f ³	Gauge Readings							
(C) Average Wet Density								
(D) Dry Density (calculated) $C/[1+(M/100)]$								
If Gauge Moisture is used $C/[1+E/100]$								
MOISTURE CONTENT								
%Gauge Moisture								
(E) Average % Moisture (gauge)								
(F) Wet Mass + Tare								
(G) Dry Mass + Tare								
(H) Moisture Mass	F - G							
(J) Tare								
(K) Dry Mass	G - J							
(M) % Moisture (actual) $[H / K] \times 100$	3/4" / #4		3/4" / #4		3/4" / #4		3/4" / #4	
OVERSIZE CORRECTION (Circle Size)								
(P) Wet Mass + Tare	(Under Nuke)							
(Q) Tare								
(R) Wet Mass	P - Q							
(T) Dry Mass	oven dried or $R / [1 + (M / 100)]$							
(V) Oversize Mass + Tare								
(W) Tare								
(X) Oversize Mass	V - W							
(Y) % Oversize	$(X / T) \times 100$							
% Passing	100 - Y							
(Z) Corrected Std. Density (see chart)								
% COMPACTION	$D/Z \times 100$							

REMARKS: _____

Signature: _____
Checked by: _____
Date: _____



STATE OF ALASKA
DOT & PF

WAQTCFOP for T 310 (METHOD A)
FIELD DENSITY WORKSHEET

Acceptance Verification Info. IA QC

Project Name: **AMATS: Old Glenn Highway, South Birchwood Loop to Peters Creek**

Federal No: **HED-0558(7)**

AKSAS No: **50946**

Material: **Subbase, Grading C**

Source: **Moose Horn Pit / Granite**

Item No: **304(1)**

Spec. (min.) **95%**

Gauge S/N: **33529**

FIELD DENSITY TEST NUMBER	SB - D - 44		
STATION	332 + 55		
C _i REFERENCE	6' Lt C/L		
GRADE REFERENCE	Top of Subbase		
QUANTITY REP'D OR PIPE/STRUCT. NO	5,000 tons		
DATE TESTED	09/11/10		

STANDARD DENSITY

WAQTC FOP for T 180: A B C D / ATM 212

Standard Density Lab Number	SB-SD-1		
D _f Standard Density T 99/T 180 (Maximum Lab)	140.4		
Optimum Moisture	7.0		
B Specific Gravity <input checked="" type="checkbox"/> +3/4" Bulk <input type="checkbox"/> -#4 App.	2.75		

DENSITY DETERMINATION

Probe Depth	8"								
	Reading #1	Reading #2	Reading #1	Reading #2	Reading #1	Reading #2	Reading #1	Reading #2	
Wet Density, (lb/ft ³ or kg/m ³)	151.8	151.6							
C Average Wet Density	151.7								
P _d Dry Density (gauge) $\gamma / [1 + (E / 100)]$	144.8								
Dry Density (actual) $\gamma / [1 + (W / 100)]$									

MOISTURE CONTENT

Use WAQTC FOP for T 255/T 265 or use gauge moisture (E) if it is within 1% of actual moisture (W).

% Moisture	Gauge	4.7	4.8						
E Average % Moisture	4.8								
F Wet Mass + Container									
G Dry Mass + Container									
J Container									
W % Moisture (actual) $[(F - G) / (G - J)] \times 100$									

GRADATION / OVERSIZE CORRECTION

*T 99 / T 180 Note: If % Oversize (P_c) is less than or equal to 5%, no correction is required.

ATM212 or *WAQTC FOP for T 224	<input checked="" type="checkbox"/> 3/4" <input type="checkbox"/> #4	<input type="checkbox"/> 3/4" <input type="checkbox"/> #4	<input type="checkbox"/> 3/4" <input type="checkbox"/> #4	<input type="checkbox"/> 3/4" <input type="checkbox"/> #4
P Wet Mass + Container	16.81			
Q Container	2.21			
M _w Wet Mass	P - Q	14.60		
M _d Dry Mass $[M_w / (1 - (E / 100))] \text{ or } [M_w / (1 - (W / 100))]$		13.93		
T +3/4" or +#4 Mass + Container		5.76		
V Container		2.21		
M _{DC} +3/4" or +#4 Mass	T - V	3.55		
P _c % Coarse Particles $(M_{DC} / M_d) \times 100$		25		
P _f % Fines	100 - P _c	75		
T 180 - Corrected Std. Density (D _d formula)		147.1		
ATM212 - Vibratory Standard (Lab Chart)				
% Compaction $P_d / \text{Max. Std. Density} \times 100$		98		

$D_d = (100 * D_f * k) / [(D_f * P_c) + (k * P_f)] \rightarrow k = (62.4 \text{ lb/ft}^3 * B) \text{ or } (1000 \text{ kg/m}^3 * B)$

TCTT = Too Coarse To Test

Signature / Qualification No. / Date: M. Goldfarb / #538 / 9-11-10

Checked by / Date: W. Nelson / 9-12-10

REMARKS:

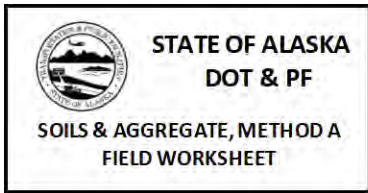

Acceptance Verification Info. IA QC

Sample No: _____

Project Name: _____

Federal No: _____ AKSAS No: _____

Material: _____ Source: _____

Item No: _____ Location: _____

Sta. / Sampled from: _____ Sampled by / Qual. No: _____

^c_l & Grade Reference: _____ Quantity Represented: _____ Date: _____

FRACTURE — WAQTC FOP for T 335

Single Face Double Face All Face

Fractured Mass F		%Q = [Q / (F + Q + N)] x 100
Questionable Mass Q		* % Questionable = _____
Unfractured Mass N		*Recount if > 15%
% Fracture		← [(F + (Q/2)) / (F + Q + N)] x 100
Test by /date:		← Spec.

GRADATION — WAQTC FOP for T 27 / T 11 — Method A

mm / USC	Increment 1	Increment 2	Cumulative Mass Retained C	Cumulative % Retained (C / M) x 100	% Passing = 100 - % Retained	Specs.
*75 / 3"						
50 / 2"						
*37.5 / 1½"						
25 / 1"						
*19.0 / ¾"						
12.5 / ½"						
*9.5 / 3/8"						
6.3 / ¼"						
*4.75 / #4						
*2.36 / #8						
2.00 / #10						
*1.18 / #16						
.850 / #20						
*.600 / #30						
.425 / #40						
*.300 / #50						
*.150 / #100						
.075 / #200						
Cum. Pan				← G	Check Sum (< 0.3%) [(A - G) / A] x 100 =	
Cumulative Mass AFTER Sieving				← G		
Dry Mass AFTER Wash BEFORE Sieving				← A		
Original Dry Mass				← M	Test by /date:	

MOISTURE CONTENT — WAQTC FOP for T 255 / T 265

C	Container	Constant Mass	
		Time	Gross Mass / Net Mass
A	Moist Mass + Contain		
Mw	Wet Mass A - C		
B	Dry Mass + Contain		
Md	Dry Mass B - C		
W	Moisture, %		
W = [(Mw - Md) / Md] x 100 ↑		% Change = _____	
Test by /date:		% Change = [(Mp - Mn) / Mp] x 100	
Mp = Previous Mass Measured / Mn = New Mass Measured			

LIQUID AND PLASTIC LIMIT — WAQTC FOP for T 89 and

		LL	PL
N	Number of Blows		
C	Container		
A	Moist Mass + Container		
Mw	Moist Mass A - C		
B	Dry Mass + Container		
Md	Dry Mass B - C		PL
W	Moisture Content, % [(Mw - Md) / Md] x 100		
LL	W x (N / 25) ^{0.121}		LL Spec
Test by /date:	Plasticity index LL - PL		PL Spec

FM →		← Fineness Modulus Target (From MD)
	to	← FM Limits (± 0.2 of FM & Design FM)
(FM = Fineness Modulus = Total of % Retained of *Sieves / 100)		

Remarks: _____

Signature / Date: _____

Checked by / Date: _____



STATE OF ALASKA
DOT & PF

SOILS & AGGREGATE, METHOD A
FIELD WORKSHEET

Acceptance Verification Info. QC

Sample No: FA-G-1

Project Name: Haines Front Street to Park Street

Federal No: HHE-095-6(032)

AKSAS No: 69999

Material: Fine Concrete Aggregate

Source: Glacier Northwest

Item No: 501(1)

Location: Bellevue, Washington

Sta. / Sampled from: Stockpile, HNS Ready Mix

Sampled by / Qual. No: P. Harmon # 007

C₁ & Grade Reference: N/A

Quantity Represented: 100 CY

Date: 03/24/11

FRACTURE — WAQTC FOP for T 335		
<input type="checkbox"/> Single Face	<input type="checkbox"/> Double Face	<input type="checkbox"/> All Face
Fractured Mass F		%Q = [Q / (F + Q + N)] x 100
Questionable Mass Q		* % Questionable =
Unfractured Mass N		*Recount if > 15%
% Fracture		← [(F+Q/2)) / (F+Q+N)] x 100
Test by / date:		← Spec.

GRADATION — WAQTC FOP for T 27 / T 11 — Method A						
mm / USC	Increment 1	Increment 2	Cumulative Mass Retained C	Cumulative % Retained (C / M) x 100	% Passing = 100 - % Retained	Specs.
*75 / 3"						
50 / 2"						
*37.5 / 1 1/2"						
25 / 1"						
*19.0 / 3/4"						
12.5 / 1/2"						
*9.5 / 3/8"			0.0	0.0	100	100
6.3 / 1/4"						
*4.75 / #4			30.9	5.4	95	95 - 100
*2.36 / #8			89.2	15.6	84	80 - 100
2.00 / #10						
*1.18 / #16			254.4	44.4	56	50 - 85
.850 / #20						
*.600 / #30			338.2	59.0	41	25 - 60
.425 / #40						
*.300 / #50			441.1	77.0	23	10 - 30
*.150 / #100			520.9	90.9	9	2 - 10
.075 / #200			556.8	97.2	2.8	3.0 max
Cum. Pan						
Cumulative Mass AFTER Sieving			557.7	← G	Check Sum (< 0.3%) [(A - G) / A] x 100 =	
Dry Mass AFTER Wash BEFORE Sieving			558.2	← A	0.1%	
Original Dry Mass			573.0	← M	Test by / date: P.H. 3/24/11	

MOISTURE CONTENT — WAQTC FOP for T 255 / T 265			
C	Container	626.3	Constant Mass
A	Moist Mass + Container	1776.3	
Mw	Wet Mass A - C	1150.0	Time
B	Dry Mass + Container	1736.7	
Md	Dry Mass B - C	1110.4	Gross Mass Net Mass
W	Moisture, %	3.6	
W = [(Mw - Md) / Md] x 100		↑	% Change =
Test by / date: P.H. 3/24/11			0.03
Mp = Previous Mass Measured / Mn = New Mass Measured			

LIQUID AND PLASTIC LIMIT — WAQTC FOP for T 89 and			
		LL	PL
N	Number of Blows		
C	Container		
A	Moist Mass + Container		
Mw	Moist Mass A - C		
B	Dry Mass + Container		
Md	Dry Mass B - C		PL
W	Moisture Content, % [(Mw - Md) / Md] x 100		
LL	W x (N / 25) ^{0.121}		LL Spec.
Test by / date:	Plasticity index LL - PL		PI Spec.

FM →	2.92	2.78	← Fineness Modulus Target (From M D)
	2.58	to	2.98 ← FM Limits (±0.2 of M x Design FM)
(FM = Fineness Modulus = Total of % Retained of *Sieves / 100)			

Remarks:

Signature / Date: Patrick H. Harmon / #007 / 3-24-11

Checked by / Date: CJK / 3-25-11

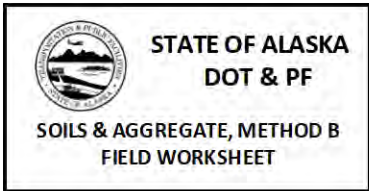

Acceptance Verification Info IA QC

Sample No: _____

Project Name: _____

Federal No: _____ AKSAS No: _____

Material: _____ Source: _____

Item No: _____ Location: _____

Sta. / Sampled from: _____ Sampled by / Qual. No: _____

City & Grade Reference: _____ Quantity Represented: _____ Date: _____

FRAC TURE — WAQTC FOP for T 335

Single Face Double Face All Face

Fractured Mass F	$\% Q = [Q / (F + Q + N)] \times 100$
Questionable Mass Q	* % Questionable = _____
Unfractured Mass N	*Recount if > 15%
% Fracture	$\leftarrow [(F + (Q/2)) / (F + Q + N)] \times 100$
Test by/date:	\leftarrow Spec. (min.)

GRADATION — WAQTC FOP for T 27 / T 11 — Method B

mm / USC	Increment 1	Increment 2	Cumulative Mass Retained C	Cumulative % Retained (C / M) x 100	% Passing = 100 - % Retained	Specs.
*75 / 3"						
50 / 2"						
*37.5 / 1½"						
25 / 1"						
*19.0 / ¾"						
12.5 / 1/2"						
*9.5 / 3/8"						
6.3 / 1/4"						
*4.75 / #4						
Indiv. Pan				\leftarrow M1		
Cumulative Mass AFTER Sieving = (D + M1)				\leftarrow G		CA Check Sum (< 0.3%)
Dry Mass AFTER Wash BEFORE Sieving				\leftarrow A		[(A - G) / A] x 100 =
Original Dry Mass				\leftarrow M		Test by/date:

MOISTURE CONTENT — WAQTC FOP for T 255 / T 265

C	Container	Constant Mass
A	Moist Mass + Container	Time \leftarrow Gross Mass / Net Mass
Mw	Wet Mass A - C	
B	Dry Mass + Container	
Md	Dry Mass B - C	
W	Moisture, %	
$W = [(Mw - Md) / Md] \times 100$		% Change = _____
Test by/date:		% Change = $[(Mp - Mn) / Mp] \times 100$
Mp = Previous Mass Measured / Mn = New Mass Measured		

$\leftarrow F = (M1 / M2) (0.001)$

mm / USC	Cumulative Mass B	Total Sample Cumulative Mass C = [F x B] + D	Cumulative % Retained (C / M) x 100	% Passing = 100 - % Retained	Specs.
*2.36 / #8					
2.00 / #10					
*1.18 / #16					
.850 / #20					
*.600 / #30					
.425 / #40					
*.300 / #50					
*.150 / #100					
.075 / #200					
Cum. Pan P					
M2 \rightarrow		\leftarrow - #4 Mass Actually Sieved			FA Check Sum (< 0.3%)
Test by/date:					[(M2 - P) / M2] x 100 =

LIQUID AND PLASTIC LIMIT — WAQTC FOP for T 89 and

	LL	PL
N	Number of Blows	
C	Container	
A	Moist Mass + Container	
Mw	Moist Mass A - C	
B	Dry Mass + Container	
Md	Dry Mass B - C	FL
W	Moisture Content, % $[(Mw - Md) / Md] \times 100$	
LL	$W \times (N / 25)^{0.121}$	LL Spec.
Test by/date: Plasticity index $LL - PL$		PI Spec.

Remarks: _____

FM \rightarrow		\leftarrow Fineness Modulus Target (From M D)
	to	\leftarrow FM Limits (± 0.2 of M & Design FM)
(FM = Fineness Modulus = Total of % Retained of *Sieves / 100)		

Signature / Date: _____

Checked by / Date: _____

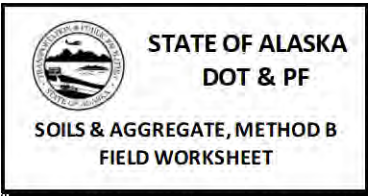

Acceptance
 Verification
 Info.
 QC
 Sample No: **BC-G-1**

Project Name: **Phillips Field Road Upgrades**

Federal No: **STP-0070(3)** AKSAS No: **63481**

Material: **Base Course, D-1** Source: **MS-02-001-32**

Item No: **301(1)** Location: **13 Mile, Miller Road**

Sta. / Sampled from: **28+50 / Roadway** Sampled by / Qual. No: **MK / #508**

Cl & Grade Reference: **12 Rt / -6" Top BC** Quantity Represented: **2000 tons** Date: **07/20/10**

FRACTURE — WAQTC FOP for T 335			
<input checked="" type="checkbox"/> Single Face	<input type="checkbox"/> Double Face	<input type="checkbox"/> All Face	
Fractured Mass F	1113.4	%Q = [Q / (F + Q + N)] x 100	
Questionable Mass Q	132.3	* % Questionable =	8
Unfractured Mass N	352.6	* Recount if > 15%	
% Fracture	74	← [(F + (Q/2)) / (F + Q + N)] x 100	
Test by / date: PH 7-21-10	70%	← Spec. (min.)	

MOISTURE CONTENT — WAQTC FOP for T 255 / T 265			
C	Container	672.1	Constant Mass
A	Moist Mass + Container	3783.8	Gross Mass
			Net Mass
			Time
			1:15 PM
Mw	Wet Mass A - C	3111.7	
			3009.2
			1:45 PM
			3679.8
			3007.7
B	Dry Mass + Container	3681.9	
Md	Dry Mass B - C	3009.8	
W	Moisture, %	3.4	
W = [(Mw - Md) / Md] x 100 ↑		% Change =	0.05
Test by / date: PH 7-20-10		% Change = [(Mp - Mn) / Mp] x 100	
Mp = Previous Mass Measured / Mn = New Mass Measured			

LIQUID AND PLASTIC LIMIT — WAQTC FOP for T 89 and				
		LL	PL	
N	Number of Blows	23		
C	Container	14.20	14.18	
A	Moist Mass + Container	34.22	23.89	
Mw	Moist Mass A - C	20.02	9.71	
B	Dry Mass + Container	31.45	22.79	
Md	Dry Mass B - C	17.25	8.61	FL
W	Moisture Content, % [(Mw - Md) / Md] x 100	16.1	12.8	13
LL	W x (N / 25) ^{0.121}	16		LL Spec.
Test by / date: PH 7-21-10	Plasticity index LL - PL	3	6 max.	PI Spec.

Remarks: _____

GRADATION — WAQTC FOP for T 27 / T 11 — Method B						
mm / USC	Increment 1	Increment 2	Cumulative Mass Retained C	Cumulative % Retained (C / M) x 100	% Passing = 100 - % Retained	Specs.
*75 / 3"						
50 / 2"						
*37.5 / 1½"						
25 / 1"			0.0	0.0	100	100
*19.0 / ¾"			251.8	3.1	97	70 - 100
12.5 / 1/2"			1253.8	15.5	85	
*9.5 / 3/8"			2222.1	27.5	73	50 - 80
6.3 / 1/4"			3291.5	40.7	59	
*4.75 / #4			4067.7	50.3	50	35 - 65
Indiv. Pan			4022.8	← M1		
Cumulative Mass AFTER Sieving = (D + M1)			8090.5	← G		CA Check Sum (< 0.3%)
Dry Mass AFTER Wash BEFORE Sieving			8094.6	← A		[(A - G) / A] x 100 = 0.1%
Original Dry Mass			8094.7	← M		Test by / date: PH 7-20-10

mm / USC	Cumulative Mass B	Total Sample Cumulative Mass C = [F x B] + D	Cumulative % Retained (C / M) x 100	% Passing = 100 - % Retained	Specs.
7.531			← F = (M1 / M2) (0.001)		
*2.36 / #8	153.6	5224.5	64.5	36	20 - 50
2.00 / #10	181.1	5431.6	67.1	33	
*1.18 / #16	238.9	5866.9	72.5	28	
.850 / #20	289.6	6248.7	77.2	23	
*.600 / #30	316.5	6451.3	79.7	20	
.425 / #40	364.9	6815.8	84.2	16	
*.300 / #50	438.1	7367.0	91.0	9	8 - 30
*.150 / #100	457.1	7510.1	92.8	7	
.075 / #200	487.8	7741.3	95.6	4.4	0 - 6
Cum. Pan P	533.1				
M2 →	534.2	← - #4 Mass Actually Sieved			FA Check Sum (< 0.3%)
Test by / date: PH 7-21-10		[(M2 - P) / M2] x 100 = 0.2%			

FM →		← Fineness Modulus Target (From M D)
	to	← FM Limits (± 0.2 of M x Design FM)
(FM = Fineness Modulus = Total of % Retained of *Sieves / 100)		

Signature / Date: **Pat Harmon / #007 / 7-21-10**

Checked by / Date: **MK / 7-22-10**

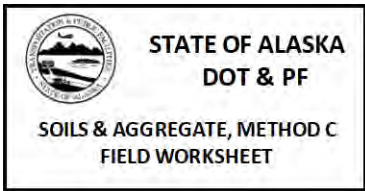

Acceptance Verification Info. IA QC

Sample No: _____

Project Name: _____

Federal No: _____ AKSAS No: _____

Material: _____ Source: _____

Item No: _____ Location: _____

Sta. / Sampled from: _____ Sampled by / Qual. No: _____

Cl & Grade Reference: _____ Quantity Represented: _____ Date: _____

FRAC TURE — WAQTC FOP for T 335

Single Face Double Face All Face

Fractured Mass F	$\%Q = [Q / (F + Q + N)] \times 100$
Questionable Mass Q	* % Questionable = _____
Unfractured Mass N	*Recount if > 15%
% Fracture	$\leftarrow [(F + (Q/2)) / (F + Q + N)] \times 100$
Test by/date: PH 7-21-10	\leftarrow Spec. (min.)

GRADATION — WAQTC FOP for T 27 / T 11 — Method C

mm / USC	Increment 1	Increment 2	Cumulative Mass Retained C	Cumulative % Retained (C/M) x 100	% Passing = 100 - % Retained	Specs.
150 / 6"						
100 / 4"						
*75 / 3"					t	
50 / 2"						
*37.5 / 1 1/2"						
25 / 1"						
*19.0 / 3/4"						
12.5 / 1/2"						
*9.5 / 3/8"						
6.3 / 1/4"						
*4.75 / #4				D		
Indiv. Pan				\leftarrow M1	CA Check Sum ($\leq 0.3\%$)	
Dry Mass AFTER Sieving = (D + M1)				\leftarrow G	$[(M - G) / M] \times 100 =$	
Original Dry Mass BEFORE Sieving				\leftarrow M		

Test by/date: _____

MOISTURE CONTENT — WAQTC FOP for T 255 / T 265

C	Container	Constant Mass	Time	Gross Mass	Net Mass
A	Moist Mass + Container				
Mw	Wet Mass A - C				
B	Dry Mass + Container				
Md	Dry Mass B - C				
W	Moisture, %				
W = $[(Mw - Md) / Md] \times 100$ ↑		% Change = _____			
Test by/date: _____		% Change = $[(Mp - Mn) / Mp] \times 100$			
Mp = Previous Mass Measured / Mn = New Mass Measured					

mm / USC	Cumulative Mass Ret. CMR_{#4}	CPR _{#4} = $(CMR_{\#4} / M_{\#4}) \times 100$	CPP _{#4} = $100 - CPR_{\#4}$	% Passing = $(CPP_{\#4} \times CPP_{\#4}) / 100$	Specs.
*2.36 / #8					
2.00 / #10					
*1.18 / #16					
.850 / #20					
*.600 / #30					
.425 / #40					
*.300 / #50					
*.150 / #100					
.075 / #200				s	
Cum. Pan P		#200 on - 3" = $[(s / \bar{f}) \times 100] \leftarrow$			
H \rightarrow		\leftarrow DRY Mass AFTER Wash		FA Check Sum ($\leq 0.3\%$)	
M _{#4} \rightarrow		\leftarrow - #4 Mass BEFORE Wash		$[(H - P) / H] \times 100 =$	

Test by/date: _____

QUID AND PLASTIC LIMIT — WAQTC FOP for T 89 and T 90

	LL	PL
N	Number of Blows	
C	Container	
A	Moist Mass + Container	
Mw	Moist Mass A - C	
B	Dry Mass + Container	
Md	Dry Mass B - C	PL
W	Moisture Content, % $[(Mw - Md) / Md] \times 100$	
LL	$W \times (N / 25)^{0.121}$	LL Spec
Test by/date: _____	Plasticity Index LL - PL	PL Spec

Remarks: _____

FM \rightarrow		\leftarrow Fineness Modulus Target (From MD)
	to	\leftarrow FM Limits (± 0.2 of FM & Design FM)
(FM = Fineness Modulus = Total of % Retained of *Sieves / 100)		

Signature / Date: _____

Checked by / Date: _____



STATE OF ALASKA
DOT & PF

SOILS & AGGREGATE, METHOD C
FIELD WORKSHEET

Acceptance Verification Info. QC

Sample No: **EXA-G-1**

Project Name: Phillips Field Road Upgrades

Federal No: STP-0070(3)

AKSAS No: 63481

Material: Unclass. Ex.-Useable Type A

Source: Existing

Item No: 203(3)

Location: Project Limits

Sta. / Sampled from: 28+50 / Roadway

Sampled by / Qual. No: MK / #508

%_L & Grade Reference: 12' Rt. / -24" Top Embankment

Quantity Represented: 10,000 tons

Date: 07/20/10

FRACTURE — WAQTC FOP for T 335	
<input type="checkbox"/> Single Face	<input type="checkbox"/> Double Face
<input type="checkbox"/> All Face	
Fractured Mass F	$\% = [(F / (F + Q + N))] \times 100$
Questionable Mass Q	$\% \text{ Questionable}$
Unfractured Mass N	*Recount if > 15%
% Fracture	$\Leftarrow [(F + (Q/2)) / (F + Q + N)] \times 100$
Test by/date: PH 7-2	$\Leftarrow \text{Spec. (min.)}$

GRADATION — WAQTC FOP for T 27 / T 11 — Method C						
mm / USC	Increment 1	Increment 2	Cumulative Mass Retained C	Cumulative % Retained	% Passing = 100 - % Retained	Specs.
150 / #6	0.0	0.0	0.0	100.0	100	
100 / #4	1468.8	1977.4	3446.2	5.5	95	
*75 / #3	2460.0	2866.7	5326.7	8.5	92	
50 / #2	8975.4	11763.2	20738.6	33.2	67	
*37.5 / #1.5	10354.2	13456.4	23810.6	38.2	62	
25 / #1	15674.3	17444.3	33118.6	53.1	47	
*19.0 / #3/4	18543.6	19555.3	38098.9	61.1	39	
12.5 / #1/2	19541.2	20339.7	39880.9	63.9	36	
*9.5 / #3/8	21841.7	22437.9	44279.6	71.0	29	
6.3 / #1/4						
*4.75 / #4	22633.8	23948.6	46582.4	74.7	25	20 - 55
Indiv. Pan	6876.9	8918.3	15795.2	\Leftarrow M1	QA Check Sum (±0.3%)	
Dry Mass AFTER Sieving = (D + M1)			62377.6	\Leftarrow G	$[(M - G) / M] \times 100 =$	
Original Dry Mass BEFORE Sieving			62378.8	\Leftarrow M	0.0	
						Test by/date: PH 7-20-10

MOISTURE CONTENT — WAQTC FOP for T 255 / T 256			
C	Container	Mass	Constant Mass
	672.1		
A	Moist Mass + Container	1534	Time
			Gross Mass
			Net Mass
			1499.7
			#####
Mw	Wet Mass A - C	861.7	827.6
			1499.3
			#####
B	Dry Mass + Container	1500	827.2
Md	Dry Mass B - C	827.6	
V	Moisture, %	4.1	
			% Change = 0.05
			Test by/date: PH 7-2
			Change = $[(M_p - M_n) / M_p] \times 100$
			M = Previous Mass Measured / Mn = New Mass Measured

mm / USC	Cumulative % Ret.	CPR ₄₄ = (CMR ₄₄ / M ₄₄) × 100	CPP ₄₄ = 100 - CPR ₄₄	% Passing = (CPP ₄₄ × CPP ₄₄) / 100	Specs.
*2.36 / #8	163.9	18.3	81.7	21	
2.00 / #10					
*1.18 / #16	298.7	33.4	66.6	17	
.850 / #20					
*.600 / #30	427.9	47.9	52.2	13	
.425 / #40					
*.300 / #50	566.7	63.4	36.6	9	
*.150 / #100	725.6	81.1	18.9	5	
.075 / #200	808.6	90.4	9.6	5	
Cum. Pan P	827.5	200 on - 3" = $[(s / t) \times 100]$		2.6	*0 - 6
H ⇒	827.9	\Leftarrow DRY Mass AFTER Wash		FA Check Sum (±0.3%)	
M₄₄ ⇒	894.3	\Leftarrow - #4 Mass BEFORE Wash		$[(H - P) / H] \times 100 =$	
				0.0	
Test by/date: PH 7-21-10					

LIQUID AND PLASTIC LIMIT — WAQTC FOP for T 89 on			
		LL	PL
N	Number of Blows	23	
C	Container	14.20	14.18
A	Moist Mass + Container	34.22	23.89
Mw	Moist Mass A - C	20.02	9.71
B	Dry Mass + Container	31.45	22.79
Md	Dry Mass B - C	17.25	8.61
			PL
V	Moisture Content, % $[(M_w - M_d) / M_d] \times 100$	16.1	12.8
			13
LL	$V \times (N / 25)^{.121}$	16	
			LL Spec
Test by/date: PH 7-21-10	Plasticity Index LL - PL	3	6 max.
			PL Spec

Remarks: _____
 #200 determined on minus 3-inch material
 Deleterious Free

FM ⇒		\Leftarrow Fineness Modulus Target (From MD)
	to	\Leftarrow FM Limits (±0.2 of Mix Design FM)
(FM = Fineness Modulus = Total of % Retained of *Sieves / 100)		

Signature / Date: Pat Harmon / #007 / 07-21-10

Checked by / Date: MK / 7-22-10

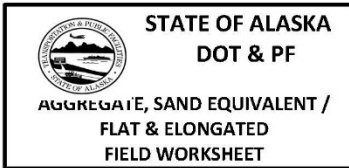

Acceptance
 Verification
 Info.
 IA
 QC
 Sample No: _____

Project Name: _____
 Federal No: _____ AKSAS No: _____
 Material: _____ Source: _____
 Item No: _____ Location: _____

Sta. / Sampled from: _____ Sampled by: _____
 C_L & Grade Reference: _____ Qualification No: _____ Date Sampled: _____

Sand Equivalent — WAQTC FOP for T 176

Sedimentation Time

Trial No.	1	2	3	
Sand Reading (SR)				Average SE <div style="border: 1px solid black; width: 50px; height: 20px; margin: 0 auto;"></div>
Clay Reading (CR)				
Sand Equivalent (SE)*				
Sedimentation Time				

*SE = (SR ÷ CR) * 100 Test by/date:

Flat and Elongated — ATM 306

Ratio: 1:5 1:3 1:2

Size Fraction mm — in.	% Retained (Original Gradation)	F&E Group CPR (Rel. to +No. 4)	F&E Group IPR	Size Group Mass	Mass F&E Size Group	% F&E Size Group (B)	Weighted % F&E Size Group
-37.5 to +19.0	-1½ to +¾						
-19.0 to +9.5	-¾ to +¾						
-9.5 to +4.75	-¾ to +No. 4						
F&E Group CPR = (Smallest Sieve in Group % Retained ÷ % No. 4 Retained) x 100						Total Weighted %	
F&E Group IPR = F&E Group CPR – Next Larger Group CPR						Test by/date: 	
% F&E Size Group (B) = [(Mass F&E Size Group) ÷ (Size Group Mass)] x 100							
Weighted F&E Size Group = [(B) x F&E Group IPR] ÷ 100							

Remarks: _____

CPR = Cumulative Percent Retained
 IPR = Individual Percent Retained

Signature / Date: _____
 Checked by / Date: _____

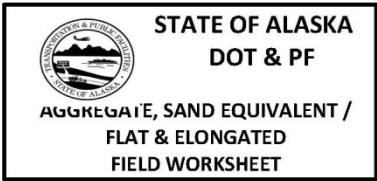

Acceptance
 Verification
 Info.
 IA
 QC
 Sample No: HMA-DA-11

Project Name: Atka Airport Runway Extension & Resurfacing

Federal No: AIP 3-02-0394-005-2008 AKSAS No: 59621

Material: HMA, Type IIB Source: Atka Quarry

Item No: P-401 Location: Atka, AK

Sta. / Sampled from: Coldfeed Sampled by: J. Christensen

C_L & Grade Reference: N/A Qualification No: 165 Date Sampled: 07/10/10

Sand Equivalent — WAQTC FOP for T 176

Sedimentation Time 20 min.

Trial No.	1	2	3	Average SE	
Sand Reading (SR)	4.1	4.3	4.1		
Clay Reading (CR)	6.3	6.7	6.5		
Sand Equivalent (SE)*	66	65	64		65
Sedimentation Time	20 min.	20 min.	20 min.		

*SE = (SR ÷ CR) * 100 Test by/date: J.C. / 7-10-10

Flat and Elongated — ATM 306

Ratio: 1:5 1:3 1:2

Size Fraction mm — in.	% Retained (Original Gradation)	F&E Group CPR (Rel. to +No. 4)	F&E Group IPR	Size Group Mass	Mass F&E Size Group	% F&E Size Group (B)	Weighted % F&E Size Group
-37.5 to +19.0 -1½ to +¾							
-19.0 to +9.5 -¾ to +⅜	35	60	60	753.6	14.5	1.9	1.1
-9.5 to +4.75 -⅜ to +No. 4	58	100	40	104.9	3.3	3.1	1.2
F&E Group CPR = (Smallest Sieve in Group % Retained ÷ % No. 4 Retained) x 100						Total Weighted %	2
F&E Group IPR = F&E Group CPR - Next Larger Group CPR						Test by/date: J.C. / 7-12-10	
% F&E Size Group (B) = [(Mass F&E Size Group) ÷ (Size Group Mass)] x 100							
Weighted F&E Size Group = [(B) x F&E Group IPR] ÷ 100							

Remarks: _____

CPR = Cumulative Percent Retained
IPR = Individual Percent Retained

Signature / Date: J. Christensen / #165 / 7-12-10

Checked by / Date: B. Anderson / 7-13-10



Acceptance Verification Info. IA QC

Sample No: _____

Project Name: _____

Federal No: _____ AKSAS No: _____

Type Mix: _____ Agg. Source: _____

Item No: _____ Asph. Cement Source / Type: _____

Sta. / Location: _____ Sampled by / Qualification No: _____

Offset: _____ Sample Method: _____ Date / Time Sampled: _____

Lift: _____ Quantity Rep'd: Lot: _____ Sublot: _____ Mix Design No: _____ Date Tested: _____

AC Content of HMA by Nuclear Method — ATM 405			
Gauge Make & Model: _____			
Gauge Serial No: _____			
Calib. No: _____		Calib. Date: _____	
*Sample Temperature	_____	⇐ *N/A if using 3241-C	
Sample Pan Mass	_____		
Calib. / Target Mass	_____ ± 5g		
18 Min. Count		Background Count	
Gauge Count	_____		
A	Uncorrected AC	Gauge, 0.01 %	
W	Moisture Content	T 329, 0.01 %	
Corrected AC A - W		0.1 %	
Test by/date: _____		⇐ Specs.	

AC Content of HMA by Ignition — WAQTC FOP for T 308 (External Balance)			
<input checked="" type="checkbox"/> Method A	Furnace No. / ID: _____	<input type="checkbox"/> °F	<input type="checkbox"/> °C
<input type="checkbox"/> Method B	Furnace Temp: _____		
B	Basket Assembly Mass		0.1 g
C	Sample Mass + Basket Assembly		Before Ignition
Mi	Initial Sample Mass C - B		0.1 g
	Furnace Mass: Basket + Sample		± 5g of Mass C
D	Basket Assembly + Sample Mass		0.1 g, After Ignition
Mf	Final Sample Mass D - B		Aggregate Mass
BC	Loss, % $[(Mi - Mf) / Mi] \times 100$		Binder Content, 0.01%
Cf	AC Correction Factor		Oven Specific
A	Uncorrected AC BC - Cf		0.01 %
W	Moisture Content		T 329, 0.01 %
Pb	Corrected AC A - W		0.1 %
Test by/date: _____		⇐ Specs.	

Moisture of HMA — WAQTC FOP for T 329			
Oven, °F:	Sample, °F:	Time In:	Time Out:
C Container, 0.1 g		Constant Mass	
		% Change @ $0.05\% = [(Mp - Mn) / Mp] \times 100$	
A	Wet + Container	1635	% Change
B	Dry + Container	10 min.	
Mi	Moist Mass A - C	+30 min.	
Mf	Dry Mass B - C	+30 min.	
W	Moisture Content, %	+30 min.	
Wet Mass $[(M - Mf) / M] \times 100$		Mp = Previous Net Mass Mn = New Net Mass	
Test by/date: _____		% Wet Mass 0.5% max ⇐ Specs.	

MSG of HMA Mix — WAQTC FOP for T 209 — Flask Method			
D	Mass of Flask + Lid + Water @ 77°F.	0.1 g	
B	Mass of Flask + Lid.	0.1 g	
C	Mass of Flask + Lid + Sample.	0.1 g	
A	Mass of Dry Sample in Air C - B		
E	Flask + Lid + De-aired Water + Sample.	0.1 g	
R	Temperature Correction Factor * (Table 2 in FOP)		
*Use only if a test temperature other than 77°F is used. R = 1 for water @ 77°F			
Temp. of Water, °F = _____		MSG = $[A / (A + D - E)] \times R$	
Test by/date: _____		Mix Design MSG: _____	

Remarks — Gauge / Ignition Printout ↓

Bulk Specific Gravity — WAQTC FOP for T 166 / T 275				Oven Temp: _____	Constant Mass	
Method C / A		Panel	Joint	% Change @ $0.05\% = [(Mp - Mn) / Mp] \times 100$		
C	Weight in Water, 0.1 g			Mp = Previous Net Mass Mn = New Net Mass		% Change
B	Mass at SSD, 0.1 g			Initial Gross	Initial Net	
X	Dry Mass + Pan, 0.1 g			Mass @ -2 hrs.	Net	
Y	Pan			Mass @ -2 hrs.	Net	
A	Dry Mass in Air, 0.1 g (X - Y)			Core Thickness (inches)		
BSG	Bulk SpG, 0.001 A / (B - C)			Panel	Joint	
Absorption, 0.1 $[(B - A) / (B - C)] \times 100$						
Lot MSG						
Compaction, % (BSG / MSG) x 100				0.00	Avg.	0.00
Test by/date: _____		Specs. ⇐				

Signature / Date: _____ Checked by / Date: _____



STATE OF ALASKA
DOT & PF

**HOT MIX ASPHALT (HMA)
FIELD WORKSHEET**

Acceptance Verification Info. IA QC

Sample No: **HMA-OD-11**

Project Name: **Old Glenn Highway: Fire Lake to South Birchwood**

Federal No: **STP-0558(6)**

AKSAS No: **58061**

Type Mix: **HMA, Type IIB**

Agg. Source: **Premier Pit/ Pruhs Const**

Item No: **401(1)**

Asph. Cement Source / Type: **Tesoro / PG 52-28**

Sta. / Location: **240+50**

Sampled by / Qualification No: **S. February / #557**

% Offset: **8' RT (right panel)**

Sample Method: **Plate**

Date / Time Sampled: **9-22-10/ 12:48 PM**

Lift: **Top**

Quantity Rep'd: **Lot: 1**

Sublot: **11**

Mix Design No: **2010A-2181**

Date Tested: **9/22/2010**

AC Content of HMA by Nuclear Method — ATM 405			
Gauge Make & Model: Troxler 3241-C			
Gauge Serial No: 781			
Calib. No: 2010A-2181		Calib. Date: 6/25/2010	
*Sample Temperature	NA	± 5g	*N/A if using 3241-C
Sample Pan Mass	562		
Calib. / Target Mass	7900		
18 Min. Count		Background Count	
Gauge Count	4618	2112	
A	Uncorrected AC	5.43	Gauge, 0.01 %
W	Moisture Content	0.04	T 329, 0.01 %
Corrected AC A - W		5.4	0.1 %
Test by/date: WM/9-22-10 5.0 - 5.8 <input checked="" type="checkbox"/> Specs.			

AC Content of HMA by Ignition — WAQTC FOP for T 308 (External Balance)			
<input checked="" type="checkbox"/> Method A	Furnace No. / ID:	10118848	<input type="checkbox"/> °F <input checked="" type="checkbox"/> °C
<input type="checkbox"/> Method B	Furnace Temp:	538	
B	Basket Assembly Mass	2987.8	0.1 g
C	Sample Mass + Basket Assembly	5366.7	Before Ignition
Mi	Initial Sample Mass C - B	2378.9	0.1 g
Furnace Mass: Basket + Sample		5363.4	± 5g of Mass C
D	Basket Assembly + Sample Mass	5235.7	0.1 g, After Ignition
Mf	Final Sample Mass D - B	2247.9	Aggregate Mass
BC	Loss, % $[(Mi - Mf) / Mi] \times 100$	5.51	Binder Content, 0.01%
Cf	AC Correction Factor	0.37	Oven Specific
A	Uncorrected AC BC - Cf	0.04	0.01 %
W	Moisture Content	5.10	T 329, 0.01 %
Pb	Corrected AC A - W	5.0 - 5.8	0.1 %
Test by/date: WM/9-22-10 5.0 - 5.8 <input checked="" type="checkbox"/> Specs.			

Moisture of HMA — WAQTC FOP for T 329			
Oven, °F:	Sample, °F:	Time In:	Time Out:
235	180	1:15PM	3:15PM
Constant Mass			% Change @ <0.05% =
			$[(Mp - Mn) / Mp] \times 100$
C	Container, 0.1 g	237.1	% Change
A	Wet + Container	2359.5	
B	Dry + Container	2358.7	90 min. 2359.30
Mi	Moist Mass A - C	2122.4	+30 min. 2358.70 0.03
Mf	Dry Mass B - C	2121.6	+30 min.
W	Moisture Content, %	0.04	+30 min.
		$[(Mi - Mf) / Mi] \times 100$	
		0.5% max	
Test by/date: WM/9-22-10 <input checked="" type="checkbox"/> Specs.			

MSG of HMA Mix — WAQTC FOP for T 209 — Flask Method		
D	Mass of Flask + Lid + Water @ 77°F, 0.1 g	7363.8
B	Mass of Flask + Lid, 0.1 g	2984.8
C	Mass of Flask + Lid + Sample, 0.1 g	5027.5
A	Mass of Dry Sample in Air C - B	2042.7
E	Flask + Lid + De-aired Water + Sample, 0.1 g	8597.6
R	Temperature Correction Factor * (Table 2 in FOP)	1.00000
*Use only if a test temperature other than 77°F is used. R = 1 for water @ 77°F		
Temp. of Water, °F =	76.4 MSG = $[A / (A + D - E)] \times R$	2.525
Test by/date: WM 9-22-10 Mix Design MSG:		2.511

↓ Remarks — Gauge / Ignition Printout ↓

Remarks section for Gauge / Ignition Printout.

Bulk Specific Gravity — WAQTC FOP for T 166 / T 275				Oven Temp: 230 F	Constant Mass
Method C / A		Panel	Joint	% Change @ <0.05% = $[(Mp - Mn) / Mp] \times 100$	
C	Weight in Water, 0.1 g	1223.4		Mp = Previous Net Mass	% Change
B	Mass at SSD, 0.1 g	2098.3		Mn = New Net Mass	
X	Dry Mass + Pan, 0.1 g	2327.8		Initial Gross	
Y	Pan	236.4		Initial Net	
A	Dry Mass in Air, 0.1 g (X - Y)	2091.4		Mass @ -2 hrs.	
BSG	Bulk SpG, 0.001 A / (B - C)	2.390		Mass @ -2 hrs.	
Absorption, 0.1 $[(B - A) / (B - C)] \times 100$		0.8		Core Thickness (inches)	
Lot MSG		2.525		Panel	Joint
Compaction, % (BSG / MSG) x 100		94.7		1.75	
Test by/date: WM / 9-23-10 Specs. ⇒ 92 - 98				2.00	
				2.00	
				1.92	Avg. 0.00
				2.0"	

Signature / Date: **William Nelson / #320 / 9-23-10**

Checked by / Date: **Billy Martin / 9-23-10**



**STATE OF ALASKA
DOT & PF**

**HMA Extracted Aggregate Gradation
FOP for T 30 - FIELD WORKSHEET**

Acceptance Verification Info. IA QC

Sample No: _____

Project Name: _____

Federal No: _____ AKSAS No: _____

Material: _____ Source: _____

Item No: _____ Location: _____

Sta. / Sampled from: _____ Sampled by / Qual. No: _____

C_L & Grade Reference: _____ Quantity Represented: Lot: _____ Sublot: _____ Date / Time: _____

FRACTURE — WAQTC FOP for T 335		
<input type="checkbox"/> Single Face <input type="checkbox"/> Double <input type="checkbox"/> All Face		
Fractured Mass F		% Q = [Q / (F + Q + N)] x 100
Questionable Mass Q		* % Questionable ⇒
Unfractured Mass N		*Recount if > 15%
% Fracture		← [(F+(Q/2)) / (F+Q+N)] x 100
Test by/date:		← Spec. (min.)

MOISTURE CONTENT — WAQTC FOP for T 255 / T 265			
C	Container	Constant Mass	
A	Moist Mass + Container	Time	Gross Mass Net Mass
Mw	Wet Mass A - C		
B	Dry Mass + Container		
Md	Dry Mass B - C		
W	Moisture, %		
W = [(Mw - Md) / Md] x 100		% Change ⇒	
Test by/date:		% Change = [(Mp - Mn) / Mp] x 100	
Mp = Previous Mass Measured / Mn = New Mass Measured			

Liquid and Plastic Limit — WAQTC FOP for T 89 and T 90			
		LL	PL
N	Number of Blows		
C	Container		
A	Moist Mass + Container		
Mw	Moist Mass A - C		
B	Dry Mass + Container		
Md	Dry Mass B - C		PL
W	Moisture Content, % [(Mw - Md) / Md] x 100		
LL	W x (N / 25) ^{0.121}		LL Spec.
Test by/date:		Plastic Index LL - PL	PI Spec.

HMA AGGREGATE GRADATION — WAQTC FOP for T 30							
mm / USC	Cumulative Mass Retained C	Cumulative % Retained (C / M) x 100	% Passing = 100 - % Retained	***Aggregate Correction		Reported % Passing	Specs.
				Add	Subtract		
50 / 2"							-
*37.5 / 1½"							-
25 / 1"							-
*19.0 / ¾"							-
12.5 / ½"							-
*9.5 / 3/8"							-
6.3 / 1/4"							-
*4.75 / #4							-
*2.36 / #8							-
2.00 / #10							-
*1.18 / #16							-
.850 / #20							-
*.600 / #30							-
.425 / #40							-
*.300 / #50							-
*.150 / #100							-
.075 / #200			*				-
Pan (only)		← P	* #200 = {(M - A) + P} / M} x 100				
Cumulative Mass AFTER Sieving					← G	Test by/date:	
Dry Mass AFTER Wash BEFORE Sieving					← A		
**Dry Sample Mass BEFORE Wash					← M ** (within 0.1% of M _f , FOP for T 308)		

** (M) vs. (M_f) check (≤ 0.1%):

$$\frac{[(M_{f(T308)} - M_{(T30)}) / M_{f(T308)}] \times 100 = \quad}{\quad} \leq 0.1\%$$
 Wetting Agent Used

Check Sum (≤ 0.2%)

$$[(A - G) / A] \times 100 = \quad$$

*** To adjust sieves correctly for aggregate correction, you must input numbers from the HMA Correction Factors Worksheet. Use minus sign in subtract column. Enter "0" in column if no adjustment.

FM ⇒		← Fineness Modulus Target (From MD)
	to	← FM Limits (± 0.2 of Mix Design FM)
(FM = Fineness Modulus = Total of % Retained of *Sieves / 100)		

Remarks: _____

Copy to Contractor / Date: _____
 Tested by / Qual. #: _____
 Signature / Date: _____
 Checked by / Date: _____



**STATE OF ALASKA
DOT & PF**

**HMA Extracted Aggregate Gradation
FOP for T 30 - FIELD WORKSHEET**

Acceptance Verification Info. IA QC

Sample No: **HMA-G-1**

Project Name: Haines Highway-Ferry Terminal to Union Street

Federal No: NH-095-6(18) AKSAS No: 72170

Material: HMA, Type II B Source: Haines Quarry & U.S. Oil

Item No: 401(1) Location: Haines, AK

Sta. / Sampled from: 133+00 Sampled by / Qual. No: Joe Example #110

C/L & Grade Reference: 6' Rt., Top Lift Quantity Represented: Lot: 1 Sublot: 1 Date / Time: 03/24/10 9:00 AM

FRACTURE — WAQTC FOP for T 335			
<input checked="" type="checkbox"/> Single Face	<input type="checkbox"/> Double Face	<input type="checkbox"/> All Face	
Fractured Mass F	1165.2	% Q = [Q / (F + Q + N)] x 100	
Questionable Mass Q	21.5	*% Questionable =>	2
Unfractured Mass N	73.1	*Recount if > 15%	
% Fracture	93	= [(F+Q/2) / (F+Q+N)] x 100	
Test by/date: JE 3-24-10	80%	= Spec. (min.)	

MOISTURE CONTENT — WAQTC FOP for T 255 / T 265			
C	Container	448.4	Constant Mass
A	Moist Mass + Container	2684.3	
Mw	Wet Mass A - C	2235.9	Time
B	Dry Mass + Container	2584.0	4:00 PM
Md	Dry Mass B - C	2135.6	4:30 PM
W	Moisture, %	4.7	
W = [(Mw - Md) / Md] x 100		% Change =>	0.01
Test by/date: JE#110/3-24-10		% Change = [(Mp - Mn) / Mp] x 100	
Mp = Previous Mass Measured / Mn = New Mass Measured			

LIQUID AND PLASTIC LIMIT — WAQTC FOP for T 89 and T 90			
N	Number of Blows	23	PL
C	Container	14.20	14.18
A	Moist Mass + Container	34.22	23.89
Mw	Moist Mass A - C	20.02	9.71
B	Dry Mass + Container	31.45	22.79
Md	Dry Mass B - C	17.25	8.61
W	Moisture Content, % [(Mw - Md) / Md] x 100	16.1	12.8
LL	W x (N / 25) ^{0.121}	16	LL Spec.
Test by/date: JE #110 / 3-25-10	Plastic Index LL - PL	3	4 Max. PI Spec.

HMA AGGREGATE GRADATION — WAQTC FOP for T 30								
mm / USC	Cumulative Mass Retained C	Cumulative % Retained (C/M) x 100	% Passing = 100 - % Retained	***Aggregate Correction		Reported % Passing	Specs.	
				Add	Subtract			
50 / 2"							-	
*37.5 / 1½"							-	
25 / 1"							-	
*19.0 / ¾"	0.0	0.0	100.0	0.0	0.0	100	100 - 100	
12.5 / 1/2"	501.1	22.3	77.7	0.0	0.0	78	71 - 83	
*9.5 / 3/8"	818.0	36.4	63.6	0.0	0.0	64	56 - 68	
6.3 / 1/4"							-	
*4.75 / #4	1259.9	56.1	43.9	0.0	0.0	44	36 - 48	
*2.36 / #8	1551.7	69.1	30.9	0.0	0.0	31	23 - 35	
2.00 / #10							-	
*1.18 / #16	1729.7	77.0	23.0	0.0	0.0	23	16 - 26	
.850 / #20							-	
*.600 / #30	1858.2	82.7	17.3	0.0	0.0	17	11 - 19	
.425 / #40							-	
*.300 / #50	1967.8	87.6	12.4	0.0	0.0	12	7 - 15	
*.150 / #100	2052.1	91.4	8.6	0.0	0.0	9	5 - 11	
.075 / #200	2115.5	94.2	* 5.8	0.0	0.0	5.8	3.5 - 7.5	
Pan (only)	20.0	= P					* #200 = {(M - A) + P} / M x 100	
Cumulative Mass AFTER Sieving			2135.5	= G		Test by/date: 3/24/10		
Dry Mass AFTER Wash BEFORE Sieving			2135.9	= A		Joe Example # 110		
**Dry Sample Mass BEFORE Wash			2246.4	= M **	(within 0.1% of Mf, FOP for T 308)			

** (M) vs. (Mf) check (≤ 0.1%): Wetting Agent Used

[[(Mf_{T308} - M_{T308}) / Mf_{T308}] x 100 =

[[(2247.9 - 2246.4) / 2247.9] x 100 = 0.1 (≤ 0.1%)

Check Sum (≤ 0.2%)

[(A - G) / A] x 100 = 0.0

***To adjust sieves correctly for aggregate correction, you must input numbers from the HMA Correction Factors Worksheet. Use minus sign in subtract column. Enter "0" in column if no adjustment

FM =>		= Fineness Modulus Target (From MD)
	to	= FM Limits (± 0.2 of Mix Design FM)
(FM = Fineness Modulus = Total of % Retained of *Sieves / 100)		

Remarks: _____

Copy to Contractor / Date: 03/24/10

Tested by / Qual. #: Joe Example / # 110

Signature / Date: _____

Checked by / Date: MK / 3-25-10



STATE OF ALASKA
DOT & PF
ATM 406
HMA Correction Factors
FIELD WORKSHEET

Acceptance Verification Info. IA QC

Sample No: _____

Project Name: _____

Federal No: _____ AKSAS No: _____

Material: _____ Agg. Source: _____

Item No: _____ Location: _____

WAQTC FOP for T 308, Method: _____ Mix Design No.: _____ Furnace No. / ID: _____

ASPHALT CEMENT CORRECTION				WAQTC FOP for T 308		CORRECTION FACTORS	AGGREGATE CORRECTION		Sample #1	Sample #2
Mix Design %AC #1		After Burn %AC #1		%AC Diff #1			D	Sample & Basket Assembly		
Mix Design %AC #2		After Burn %AC #2		%AC Diff #2			B	Basket Assembly		
Cf	AC CORRECTION FACTOR (average of differences)						Mf	Mass after Ignition (D-B)		

HMA AGGREGATE GRADATION				WAQTC FOP for T 30		AGGREGATE CORRECTION						WAQTC FOP for T 308			
mm / USC	Correction Factor Blank Sample			Correction Factor Sample #1			Correction Factor Sample #2			Cumulative Mass Retained C	Cumulative % Retained (C/M) x 100	% Passing = 100 - % Retained	Cumulative Mass Retained C	Cumulative % Retained (C/M) x 100	% Passing = 100 - % Retained
	Cumulative Mass Retained C	Cumulative % Retained (C/M) x 100	% Passing = 100 - % Retained	Cumulative Mass Retained C	Cumulative % Retained (C/M) x 100	% Passing = 100 - % Retained	Cumulative Mass Retained C	Cumulative % Retained (C/M) x 100	% Passing = 100 - % Retained						
25 / 1"															
19.0 / 3/4"															
12.5 / 1/2"															
9.5 / 3/8"															
4.75 / #4															
2.36 / #8															
1.18 / #16															
.600 / #30															
.300 / #50															
.150 / #100															
.075 / #200															
Cum. Pan Mass															
			←Check Sum ≤0.2												←Check Sum ≤0.2
Dry Mass After Wash															
M	Mass Before Wash			M	Mass Before Wash			M	Mass Before Wash						Calculate & Report % Passing to 0.1%

mm / USC	Allowable Difference	Blank Sample % Passing	Sample #1 % Passing	Sample #2 % Passing	Difference from Blank Sample		Average Difference	*Sieves to Adjust	
					#1	#2		Add	Subtract
25 / 1"	± 5.0 %								
19.0 / 3/4"	± 5.0 %								
12.5 / 1/2"	± 5.0 %								
9.5 / 3/8"	± 5.0 %								
4.75 / #4	± 5.0 %								
2.36 / #8	± 5.0 %								
1.18 / #16	± 3.0 %								
.600 / #30	± 3.0 %								
.300 / #50	± 3.0 %								
.150 / #100	± 3.0 %								
.075 / #200	± 0.5 %								

Adjust Sieves for FOP for T 30 Gradation: Use "0" if adjustment N/A; use minus sign for negative numbers in subtract column.

Remarks: _____

Signature / Date: _____
 **Checked by / Date: _____

Rev.12/31/05

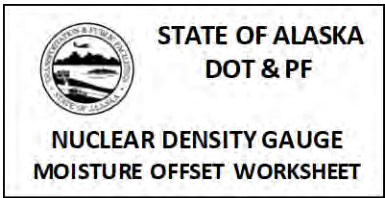

Project Name: _____
 Federal No: _____ AKSAS No: _____
 Material: _____ Source: _____
 Item No: _____ Location: _____
 Gauge Serial No. / Model No: _____

OVEN DRY MOISTURE (0.1%) 1) _____ 2) _____ 3) _____ 4) _____ 5) _____ _____ (A)* AVERAGE	GAUGE MOISTURE (0.1%) 1) _____ 2) _____ 3) _____ 4) _____ 5) _____ _____ (B)* AVERAGE
--	---

A — B = _____ (C)*

OFFSET FACTOR (k) = $\frac{C}{100 + B} \times 1000 = \boxed{}$ ** / ***

NOTE:
 *Round (A), (B), & (C) to one decimal place.
 **Report offset factor (k value) as a whole number.
 ***Remember to maintain the appropriate algebraic symbol (– or +

MOISTURE CONTENT — WAQTC FOP for T 255 / T 265			
$\%M = [(a - b) / (b - c)] \times 100$			
	c	a	b
Sample #.	Tare Mass	Wet Mass + Tare	Dry Mass + Tare
1			
2			
3			
4			
5			

Remarks: _____

Signature / Qualification No. / Date: _____

Checked by / Date: _____



STATE OF ALASKA
DOT & PF

NUCLEAR DENSITY GAUGE
MOISTURE OFFSET WORKSHEET

Project Name: Old Glenn Highway, South Birchwood Loop to Peters Creek
 Federal No: ARA-0558(7) AKSAS No: 50946
 Material: Borrow, Type A Source: Moose Horn Pit / Granite
 Item No: 206(6A) Location: Chugiak, AK
 Gauge Serial No. / Model No: 33402 / Troxler 3430

**OVEN DRY
MOISTURE
(0.1%)**

- 1) 6.9
- 2) 4.5
- 3) 3.7
- 4) 5.1
- 5) 4.2

4.9 (A)*
AVERAGE

**GAUGE
MOISTURE
(0.1%)**

- 1) 7.5
- 2) 5.1
- 3) 4.2
- 4) 5.8
- 5) 4.8

5.5 (B)*
AVERAGE

A - B = -0.6 (C)*

OFFSET FACTOR (k) = $\frac{C}{100 + B} \times 1000 = \boxed{-6}$ ** / ***

NOTE:

- *Round (A), (B), & (C) to one decimal place.
- **Report offset factor (k value) as a whole number.
- ***Remember to maintain the appropriate algebraic symbol (- or +)

MOISTURE CONTENT — WAQTC FOP for T 255 / T 265			
%M = [(a - b) / (b - c)] x 100			
Sample #:	c	a	b
	Tare Mass	Wet Mass + Tare	Dry Mass + Tare
1	1.25	11.97	11.28
2	1.12	12.02	11.55
3	1.83	13.53	13.11
4	1.46	12.66	12.12
5	1.55	11.88	11.46

Remarks: _____

Signature / Qualification No. / Date: Cleve Cooper / #002 / 3-29-11
 Checked by / Date: Tom Fisher / 3-30-11



**STATE OF ALASKA
DOT & PF
Construction**

**ATM 412 Control Strip
FIELD WORKSHEET**

Acceptance Information Assurance

Project Name: Kotzebue A/P & Safety Area Improvements
 State No: AIP 3-02-0160-016 2010
 Material RAP Source Existing
 Item No. P-181 Spec. 98% Gauge Serial No. 22929

FIELD DENSITY TEST NUMBER	RAP-D-46	RAP-D-47	RAP-D-47R	RAP-D-48					
STATION	112+27	423+08	422+77	440+69					
STATION									
STATION									
C/L REFERENCE	12' RCL	06' LCL	CL	5' RCL					
C/L REFERENCE									
C/L REFERENCE									
GRADE REFERENCE	Top RAP	Top RAP	Top RAP	Top RAP					
QUANTITY REPRESENTED	1000 tons	1000 tons	1000 tons	1000 tons					
DATE TESTED									
STANDARD DENSITY BY: <input checked="" type="checkbox"/> ATM 412 <input type="checkbox"/> ASTM D 1557 <input type="checkbox"/> ATM 1-12									
Lab Number	RAP-SD-4	RAP-SD-4	RAP-SD-4	RAP-SD-4					
(A) Standard WET Density (Field Established)	150.4	150.4	150.4	150.4					
Optimum Moisture	N/A	N/A	N/A	N/A					
(B) Bulk Specific Gravity	N/A	N/A	N/A	N/A					
DENSITY DETERMINATION									
Probe Depth	Backscatter		Backscatter		Backscatter		Backscatter		
	Reading #1	Reading #2	Reading #1	Reading #2	Reading #1	Reading #2	Reading #1	Reading #2	
Wet Density, lbm/f ³	Gauge Readings	147.4	147.8	142.3	139.7	148.1	147.4	149.2	148.7
Wet Density, lbm/f ⁴	Gauge Readings								
Wet Density, lbm/f ⁵	Gauge Readings								
(C) Average Wet Density		147.6	141.0	147.8	149.0				
% COMPACTION	C/A x 100	98%	91%	98%	99%				

REMARKS: _____

Signature: _____
 Checked by: _____
 Date: _____



STATE OF ALASKA
DOT & PF
Construction
ATM 412 Control Strip
FIELD WORKSHEET

Acceptance Information Assurance

Project Name: _____
 State No: _____
 Material _____ Source _____
 Item No. _____ Spec. _____ Gauge Serial No. _____

FIELD DENSITY TEST NUMBER				
STATION				
STATION				
STATION				
C/L REFERENCE				
C/L REFERENCE				
C/L REFERENCE				
GRADE REFERENCE				
QUANTITY REPRESENTED				
DATE TESTED				

STANDARD DENSITY BY:

ATM 412 ASTM D 1557 ATM 1-12

Lab Number				
(A) Standard Density (Field Established)				
Optimum Moisture				
(B) Bulk Specific Gravity				

DENSITY DETERMINATION

Probe Depth		Backscatter		Backscatter		Backscatter		Backscatter	
		Reading #1	Reading #2	Reading #1	Reading #2	Reading #1	Reading #2	Reading #1	Reading #2
Wet Density, lbm/f ³	Gauge Readings								
Wet Density, lbm/f ⁴	Gauge Readings								
Wet Density, lbm/f ⁵	Gauge Readings								
(C) Average Wet Density									
% COMPACTION	C/A x 100								

REMARKS: _____

Signature: _____
 Checked by: _____
 Date: _____

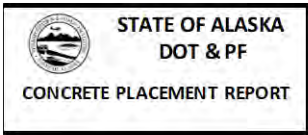

Acceptance Verification Info IA QC

PROJECT NAME: _____ POUR No: _____
 FEDERAL No: _____ AKSAS No: _____
 ITEM No: _____ TICKET No: _____ DATE: _____
 TRUCK No. _____ NRMCA Certified? Yes No Mix Design No: _____

BATCH (SCALE) WEIGHTS			
A. Coarse Aggregate (CA) _____		Type of Construction: _____	
B. Intermediate Aggregate (IA) _____		Bridge No: _____ Station(s): _____	
C. Fine Aggregate or Sand (FA) _____		Portion of Structure or Section Represented: _____	
D. Cements* _____ + _____ * + _____ = Total: _____		Quantity Represented: <input type="checkbox"/> 50 CY <input type="checkbox"/> 1/2 Days Pour	
E. Water from batch ticket: _____ (gallons x 8.33)		<input type="checkbox"/> 200 CY <input type="checkbox"/> Precast Member	
E1. plus water added at site: _____ (gallons x 8.33)		Source / Manufacturer of Concrete: _____	
F. Total Batch Weight (A + B + C + D + E + E1) _____		Brand & Type of Cement (MD): _____	
* D2 and D3 for Fly Ash, Slag or Silica Fume			

AGGREGATE MOISTURE CORRECTIONS			
C A	a. Moistures (decimal) _____ + _____ = _____ <small>(free water) absorption * (total moisture)</small>	Class of Concrete: _____ (A, A-A, P, DS, Other)	
	b. Dry Weight [A / (1 + total moisture)] _____	Mix time: _____	
	c. SSD Weight [b * (1 + absorption)] _____	Pour time: Start: _____ Finish: _____	
I A	d. Moistures (decimal) _____ + _____ = _____ <small>(free water) absorption * (total moisture)</small>	Weather Conditions: _____	
	e. Dry Weight [B / (1 + total moisture)] _____	Concrete Sampled from: _____	
	f. SSD Weight [e * (1 + absorption)] _____	Concrete Wasted: _____	
F A	g. Moistures (decimal) $\frac{0.0227}{\text{free water}} + \frac{0.012}{\text{absorption *}} = \frac{0.0347}{\text{total moisture}}$	Concrete Rejected: _____	
	h. Dry Weight [C / (1 + total moisture)] _____ 0	Test Specimen Identification: <input type="checkbox"/> Compressive <input type="checkbox"/> Flexural	
	j. SSD Weight [h * (1 + absorption)] _____ 0	Specimens making procedure: _____	
* from Mix Design		Initial cure procedure: _____	
		No. of Test Specimens and sizes: _____	

WATER WEIGHT CORRECTIONS		REMARKS:																					
G. Free Water in CA (A - c) _____																							
H. Free Water in IA (B - f) _____																							
J. Free Water in FA (C - j) _____																							
K. Total Water Weight (E + E1 + G + H + J) _____																							
L. Total Water in Gallons (K / 8.34) _____																							
		<table border="1" style="width:100%; border-collapse: collapse;"> <thead> <tr> <th>Admixture</th> <th>MD oz/cy</th> <th>oz/batch from ticket</th> <th>oz/cy</th> <th>% off MD</th> </tr> </thead> <tbody> <tr><td> </td><td> </td><td> </td><td> </td><td> </td></tr> <tr><td> </td><td> </td><td> </td><td> </td><td> </td></tr> <tr><td> </td><td> </td><td> </td><td> </td><td> </td></tr> </tbody> </table>		Admixture	MD oz/cy	oz/batch from ticket	oz/cy	% off MD															
Admixture	MD oz/cy	oz/batch from ticket	oz/cy	% off MD																			

TEST DATA		↓ SPECIFICATIONS ↓	↓ MD TEST RESULT DATA ↓
Concrete Temperature (°F): _____ Slump (in): _____			
Air Content, % (- Agg. Corr. Factor from MD) _____			
M. Density, (pcf) _____			

BATCH DATA		↓ MD Checks ↓	
N. Sacks of Cement per Batch (D / 94) _____		Cement Factor, Sacks/CY (MD): _____	
P. Yield, CY per Batch [(F / M) / 2.7] _____		W / Cm, lbs. / lbs. (MD) _____	
R. Water / Cementitious Ratio, lbs. / lbs. (K / D) _____		% 2nd cementitious material (MD): _____	
S. % 2nd cementitious material [(D2 / Total) x 100] _____		% 3rd cementitious material (MD): _____	
T. % 3rd cementitious material [(D3 / Total) x 100] _____		% Sand (MD): _____	
U. % Sand [j / (c + f + j)] x 100 _____		Mix Ratios (MD) 1: _____ : _____ : _____	
V. Mix Ratios 1: (c / D) : (f / D) : (j / D) _____ : _____ : _____ <small>(CA) (IA) (FA)</small>		<small>(CA) (IA) (FA)</small>	

SSD BATCH WEIGHTS REDUCED FOR 1 CY		↓ SPECIFICATIONS ↓	
Coarse Aggregate (c / P) _____	% off MD _____	* _____ ± 2% of _____	Batch Weights / CY (from MD)
Intermediate Aggregate (f / P) _____		* _____ ± 2% of _____	
Fine Aggregate (j / P) _____		* _____ ± 2% of _____	
Cement Content (D / P) _____		_____ ± 1% of _____	
Water (K / P) _____		_____ ± 3% of _____	

INSPECTOR / QUAL. No: _____ CHECKED BY: _____ DATE: _____
 PROJECT ENGINEER: _____ DATE: _____



STATE OF ALASKA
DOT & PF

CONCRETE PLACEMENT REPORT

Acceptance Verification Info IA QC

PROJECT NAME: **Glenn Hwy., MP 109-118 Resurface, Box Culverts** POUR No: **27**
 FEDERAL No: **IM-0A1-5(27)** AKSAS No: **52095**
 ITEM No: **514(1)** TICKET No: **227426** DATE: **7/30/11**
 TRUCK No. **459** NRMCA Certified? Yes No Mix Design No: **Cast5 SCC 6500**

BATCH (SCALE) WEIGHTS																									
A. Coarse Aggregate	(CA)	11380	Type of Construction: <u>Box Culvert Section, 14'x12'x4'</u> Bridge No: <u>n/a</u> Station(s): <u>MP 114.5</u> Portion of Structure or Section Represented: <u>BC-2</u> Quantity Represented: <input type="checkbox"/> 50 CY <input type="checkbox"/> 1/2 Days Pour <input type="checkbox"/> 200 CY <input checked="" type="checkbox"/> Precast Member Source / Manufacturer of Concrete: <u>AS&G</u> Brand & Type of Cement (MD): <u>ABI Type III</u>																						
B. Intermediate Aggregate	(IA)	4900																							
C. Fine Aggregate or Sand	(FA)	16360																							
D. Cements* 7090 + _____ + _____ = Total:		7090																							
E. Water from batch ticket:	(gallons x 8.33)	2480																							
E1. plus water added at site:	(gallons x 8.33)																								
F. Total Batch Weight (A + B + C + D + E + E1)		42210																							
* D2 and D3 for Fly Ash, Slag or Silica Fume																									
AGGREGATE MOISTURE CORRECTIONS																									
C A	a. Moistures (decimal)	-0.0038 + 0.010 = 0.0062 <small>(free water) absorption * (total moisture)</small>	Class of Concrete: <u>SCC</u> (A, A-A, P, DS, Other) Mix time: <u>12:27:00 PM</u> Pour time: Start: <u>1:13 PM</u> Finish: _____ Weather Conditions: <u>Sunny 65</u> Concrete Sampled from: <u>Truck Chute</u> Concrete Wasted: <u>none</u> Concrete Rejected: <u>none</u> Test Specimen Identification: <input checked="" type="checkbox"/> Compressive <input type="checkbox"/> Flexural Specimens making procedure: <u>WAQTC FOR for AASHTO T23</u> Initial cure procedure: <u>WAQTC FOR for AASHTO T23</u> No. of Test Specimens and sizes: <u>4 ea., 4"x8"</u>																						
	b. Dry Weight [A / (1 + total moisture)]	11310																							
	c. SSD Weight [b * (1 + absorption)]	11423																							
I A	d. Moistures (decimal)	0.0049 + 0.010 = 0.0149 <small>(free water) absorption * (total moisture)</small>																							
	e. Dry Weight [B / (1 + total moisture)]	4828																							
	f. SSD Weight [e * (1 + absorption)]	4876																							
F A	g. Moistures (decimal)	0.0227 + 0.012 = 0.0347 <small>(free water) absorption * (total moisture)</small>																							
	h. Dry Weight [C / (1 + total moisture)]	15811																							
	j. SSD Weight [h * (1 + absorption)]	16001																							
* from Mix Design																									
WATER WEIGHT CORRECTIONS			Remarks: _____																						
G. Free Water in CA	(A - c)	-43																							
H. Free Water in IA	(B - f)	24	<table border="1" style="width:100%; border-collapse: collapse;"> <thead> <tr> <th>Admixture</th> <th>MD oz/cy</th> <th>oz/batch from ticket</th> <th>oz/cy</th> <th>% off MD</th> </tr> </thead> <tbody> <tr> <td>Micro Air</td> <td>6.45</td> <td>60.00</td> <td>5.5</td> <td>-15%</td> </tr> <tr> <td>PS-1466</td> <td>65.8</td> <td>532.00</td> <td>48.8</td> <td>-26%</td> </tr> <tr> <td>BASF VMA</td> <td>39.4</td> <td>388.00</td> <td>35.6</td> <td>-10%</td> </tr> </tbody> </table>			Admixture	MD oz/cy	oz/batch from ticket	oz/cy	% off MD	Micro Air	6.45	60.00	5.5	-15%	PS-1466	65.8	532.00	48.8	-26%	BASF VMA	39.4	388.00	35.6	-10%
Admixture	MD oz/cy	oz/batch from ticket				oz/cy	% off MD																		
Micro Air	6.45	60.00				5.5	-15%																		
PS-1466	65.8	532.00				48.8	-26%																		
BASF VMA	39.4	388.00	35.6	-10%																					
J. Free Water in FA	(C - j)	359																							
K. Total Water Weight	(E + E1 + G + H + J)	2820																							
L. Total Water in Gallons	(K / 8.34)	338.1																							
TEST DATA			↓ SPECIFICATIONS ↓																						
Concrete Temperature (°F):	67	Slump (in):	27.00	↓ MD TEST RESULT DATA ↓																					
Air Content, % (-Agg. Corr. Factor from MD)	6.0			30" max. Spread																					
M. Density, (pcf)	143.2			6.0% + 1.5%																					
				11"																					
				6.0%																					
				143.8																					
BATCH DATA			↓ MD Checks ↓																						
N. Sacks of Cement per Batch	(D / 94)	75.4	6.9 Cement Factor, Sacks/CY (MD): _____																						
P. Yield, CY per Batch	[(F / M) / 27]	10.9	W / On, lbs. / lbs. (MD) <u>.45 max</u>																						
R. Water / Cementitious Ratio, lbs. / lbs.	(K / D)	0.40	% 2nd cementitious material (MD): <u>n/a</u>																						
S. % 2nd cementitious material	[D2 / (Total) x 100]	N/A	% 3rd cementitious material (MD): <u>n/a</u>																						
T. % 3rd cementitious material	[D3 / (Total) x 100]	N/A	% Sand (MD): <u>40%</u>																						
U. % Sand	[j / (c + f + j)] x 100	49.5	Mix Ratios (MD) 1: _____ : _____ : _____																						
V. Mix Ratios 1: (c / D) : (f / D) : (j / D)	1.61 : 0.69 : 2.26		(CA) (IA) (FA)																						
	(CA) (IA) (FA)																								
SSD BATCH WEIGHTS REDUCED FOR 1 CY			↓ SPECIFICATIONS ↓																						
Coarse Aggregate	(c / P)	1048	Batch Weights / CY (from MD)																						
Intermediate Aggregate	(f / P)	447	* 1023 - 1065 ± 2% of <u>1044</u>																						
Fine Aggregate	(j / P)	1468	* 431 - 449 ± 2% of <u>440</u>																						
Cement Content	(D / P)	650	* 1438 - 1496 ± 2% of <u>1467</u>																						
Water	(K / P)	259	651 - 665 ± 1% of <u>658</u>																						
			286 - 304 ± 3% of <u>295</u>																						

INSPECTOR / QUAL. No: 568 CHECKED BY: _____ DATE: _____

PROJECT ENGINEER: _____ DATE: _____



**STATE OF ALASKA
DOT & PF**

**RELATIVE STANDARD DENSITY OF SOILS
by the CONTROL STRIP METHOD
ATM 309 - FIELD WORKSHEET**

Acceptance Information

Sample No: _____

Project Name: _____

Federal No: _____ AKSAS No: _____

Material: _____ Source: _____

Item No: _____ Gauge Model: _____ Gauge S/N: _____

Lane: _____ Width: _____ Station to Station: _____ Std. Count: _____

Date: _____

**Initial (Control Strip) readings shall be taken in backscatter position. The final (ten random location) readings shall be performed in direct transmission when practicable. All readings are to be Dry Density.*

***Continue the compaction & testing cycle until there is a pass with less than 1 lb/ft³ increase in the average dry density of the test locations, and a second consecutive pass with less than 1 lb/ft³ increase in the average dry density of the test locations.*

Equipment:	Pass #:	*Location 1	*Location 2	*Location 3	**Average	Remarks:
Roller #1:	1					
	2					
	Roller Brand:	3				
	Roller Model Number:	4				
	Roller Type:	5				
	6					
	Compaction Mode: Vibe or Static (Circle)	7				
Roller #2:	1					
	2					
	Roller Brand:	3				
	Roller Model Number:	4				
	Roller Type:	5				
	6					
	Compaction Mode: Vibe or Static (Circle)	7				

Locations ⇒ 1 2 3 4 5 6 7 8 9 10

Reading 1 (1 minute)											Relative Standard Density
Reading 2 (1 minute)											
Average Dry Density											

Reading 1 (% moisture)											Average Moisture
Reading 2 (% moisture)											
Average % Moisture											

Remarks: _____

Signature / Qualification No / Date: _____

Checked by / Date: _____

Rev. 06/01/2019



**STATE OF ALASKA
DOT & PF
Construction**

**ATM 213 - In-place Density Report
for ATM 309- Control Strip SD**

<input checked="" type="checkbox"/> Acceptance	<input type="checkbox"/> Information	<input type="checkbox"/> Assurance
--	--------------------------------------	------------------------------------

Project Name: _____

State No: _____

Material _____ Source _____

Item No. _____ Spec. _____ Gauge Serial No. _____

FIELD DENSITY TEST NUMBER				
STATION				
STATION				
STATION				
C/L REFERENCE				
C/L REFERENCE				
C/L REFERENCE				
GRADE REFERENCE				
QUANTITY REPRESENTED				
DATE TESTED				

STANDARD DENSITY BY: ATM 309

Lab Number				
(A) Standard Density (Field Established)				
Optimum Moisture	N/A	N/A	N/A	N/A
(B) Bulk Specific Gravity	N/A	N/A	N/A	N/A

DENSITY DETERMINATION

Probe Depth		Backscatter		Backscatter		Backscatter		Backscatter	
		Reading #1	Reading#2	Reading #1	Reading #2	Reading #1	Reading#2	Reading #1	Reading#2
Wet Density, lbm/ft ³	Gauge Readings								
Wet Density, lbm/ft ³	Gauge Readings								
Wet Density, lbm/ft ³	Gauge Readings								
(C) Average Wet Density									
% COMPACTION	C/A x 100								

REMARKS: _____

Signature: _____

Checked by: _____

Date: _____



Acceptance
 Verification
 Info
 PA
 QC

Sample No: _____

Project Name: _____

Federal No: _____ AKSAS No: _____

Material: _____ Source: _____

Item No: _____ Specification: _____ Quantity Represented: _____

Gauge Model No: _____ Gauge Serial No: _____ Density Standard (pcf): _____ Standard No. ID: _____

*Correlation Factor: _____ Location and Area Represented: _____ Date: _____

FIELD DENSITY TEST NUMBER	1	2	3	4	5	6	7	8	9	10
STATION										
C_u REFERENCE (Offset)										
GRADE REFERENCE										
QUANTITY REPRESENTED										

DENSITY DETERMINATION		(Reading #2 is rotated 90° from Reading #1)									
		Bariscale Mode									
D	Wet Density, lbs/ft ³ (Difference ? 2.5 lbs/ft ³)	Reading #1									
E	Average Wet Density	Reading #2									
F	Adjusted Density (use *Correlation Factor)										
G	% Compaction (E or F / Density Std.) x 100										

CORRELATION with CORES											
WAQTC FOP for AASHTO T 166											
H	Core Thickness (inches)	Core 1	Core 2	Core 3	Core 4	Core 5	Core 6	Core 7	Core 8	Core 9	Core 10
A	Mass of Dry Specimen in Air										
B	Mass of SSD Specimen in Air										
C	Weight of Specimen in Water										
J	Bulk Specific Gravity (0.001)										
K	Unit Weight = Bulk SpG x 62.4 (pcf)										
E	Average Wet Density (from E above)										
L	Difference = Unit Weight - Average Wet Density K - E										

Filler Material (Native Finest) used? _____ Average Difference: _____
 Standard Deviation (? 2.5): _____

Remarks: _____
 Test by / Certification No: _____
 Signature / Date: _____
 Checked by / Date: _____

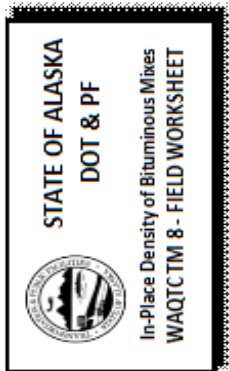

Acceptance
 Verification
 Info
 IA
 QC

Sample No: CABCD-1

Project Name: POW - Craig-Klawock Highway Reconditioning

Federal No: HDP-0003-93 AKSAS No: 68744

Material: Crushed Asphalt Base Course Source: Project Grindings

Item No: 300(1) Specification: 98% min. Quantity Represented: 5,000 S.Y.

Gauge Model No: 3430 Gauge Serial No: 33529 Density Standard (pcf): 145.5 Standard NomD: CABCD-2

*Correlation Factor: N/A Location and Area Represented: Sta. 31+00 to 50+00 Date: 06/24/10

FIELD DENSITY TEST NUMBER	1	2	3	4	5	6	7	8	9	10
STATION	31+25	36+35	41+35	46+40	49+95	50+00	48+05	44+00	39+50	34+75
C_L REFERENCE (Offset)	6RL	4RL	3RL	8RL	5RL	10RL	41L	61L	31L	81L
GRADE REFERENCE	Top CABCD	Top CABCD	Top CABCD	Top CABCD	Top CABCD	Top CABCD	Top CABCD	Top CABCD	Top CABCD	Top CABCD
QUANTITY REPRESENTED	375	375	375	375	375	375	375	375	375	375

Backscatter Mode (Reading #2 is rotated 90° from Reading #1)

D	Wet Density, lbs/ft ³ (Difference ? 2.5 lbs/ft ³)		DENSITY DETERMINATION							
	Reading #1	Reading #2	<input checked="" type="checkbox"/> Backscatter Mode							
	143.5	145.2	144.1	143.8	142.9	146.0	145.6	144.3	143.9	146.2
	144.2	145.3	144.6	145.0	144.4	144.7	144.9	143.9	145.2	144.8
E	143.9	145.3	144.4	144.4	143.7	145.4	145.3	144.1	144.6	145.5
F	Adjusted Density (use *Correlation Factor)									
G	% Compaction (E or F / Density Std.) x 100									
	99.9	99.9	99.2	99.2	98.8	99.9	99.9	99.0	99.4	100.0

CORRELATION with CORES

WAQTC FOP for AASHTO T 166

H	Core Thickness (inches)	Core 1	Core 2	Core 3	Core 4	Core 5	Core 6	Core 7	Core 8	Core 9	Core 10
A	Mass of Dry Specimen in Air										
B	Mass of SSD Specimen in Air										
C	Weight of Specimen in Water										
J	Bulk Specific Gravity (0.001)										
K	Unit Weight = Bulk SpG x 62.4 (pcf)										
E	Average Wet Density (from E above)										
L	Difference = Unit Weight - Average Wet Density K - E										

Filler Material (Native Fines) used?

Average Difference: _____

Standard Deviation (? 2.5): _____

Remarks

Test by / Qualification No: C.J. McKean0909

Signature / Date: _____

Density Strip Average = 99.4%

Checked by / Date: NUB-26-10



STATE OF ALASKA
DOT & PF

Sand Cone ATM 211

Acceptance Verification Info. QC

Sample No: _____

Project Name: _____

Federal No: _____ AKSAS No: _____

Material: _____ Source: _____

Item No: _____ Location: _____

Sta. / Sampled from: _____ Sampled by / Qual. No: _____

°/L & Grade Reference: _____ Quantity Represented: _____ Date: _____

Determination of Bulk Density of Sand and Cone Correction Factor

Bulk Density

Mf	_____	Mass of filled calibration container
Mt	_____	Mass of the calibration container
V	_____	Volume of the container in cubic feet
Pb	_____	Bulk Density

$$P_b = \frac{m_f - m_t}{V}$$

Cone Correction Factor

Mi	_____	Mass of Filled Aparatus
Mf	_____	Mass of Aparatus After Filling Cone
C	_____	Cone Correction Factor

$$C = \frac{m_i - m_f}{P_b}$$

Density Determination

Mi	_____	Mass of Filled Aparatus
Mf	_____	Mass of Aparatus After Filling Hole
Vh	_____	Volume of Hole
Md	_____	Mass of Dry Material from Hole
Pd	_____	Dry Density
D	_____	Corrected Standard Density
%C	_____	Percent Compaction

$$V_h = \frac{m_i - m_f}{P_b} - C$$

$$P_d = \frac{M_d}{V_h}$$

Remarks

Signature _____

Checked _____

Rev. 03/07/11

Reserved SP 11

This page intentionally left blank.

Materials Sample Identification System SP 12

Table VII, Materials Sample Identification System, also see ACM 5.4			
<p>Each materials sample taken on a construction contract project will be assigned a four part number that identifies the type of sample, the type of material, the test that will be performed on the sample and the sequential number of the test in that series on that type of material and sample. When a test sample fails to meet the specifications, the test number is circled in the Materials Testing Summary. A retest of a failing test is identified by adding the letter "A" after the test number for the first retest; a second retest adds the letter "B", and so on. Samples sent to the regional lab for testing will also be identified by this system, in addition to the project name and number, the location the sample was taken, and the name of the sampler. This sample identification system will be used on test results from the field lab and from the regional lab, and on the Materials Testing Summary form.</p>			
Types of Samples			
Acceptance	No prefix	Information	I
Independent Assurance	A	Quality	Q
Types of Materials			
Aggregate Base Course (C-1, D-1 etc)	BC ()	Gas Line Conduit	GC
Aggregate Surface Course	SC	Hot Mix Asphalt	HMA
Asphalt Cement	AC	Grout	GR
Asphalt Pathway	AP	Manhole Type (1, II, III)	MH()
Asphalt Sidewalk	AS	Medium Cure Liquid Asphalt	MC
Asphalt Surface Treatment	AST	Mineral Filler	MF
Asphalt Treated Base Course	ATB	Performance Grade Liquid Asphalt	PG
Bed Course Material	BCM	Porous Backfill	PB
Bedding and Backfill	BB	Reclaimed Asphalt Pavement	RAP
Borrow Material Type (A, B, C)	BM()	Rip Rap	RR
Common Excavation	CX	Rock Excavation	RX
Concrete Cylinder	CYL		
Concrete Coarse Aggregate	CA	Sewer Conduit	SC
Concrete Fine Aggregate	FA	Sidewalk	SW
Cover Coat Grading B	CCB	Stone Mastic Asphalt	SMA
Crushed Asphalt Base Course	CABC	Structural Backfill Material	SF
Culvert	C	Structural Plate Pipe	SPP
Ditch Lining	DL	Subbase (A, B, C, D, E)	SB()
Electrical Conduit	EC	Telephone Conduit	TC
Electrical - Miscellaneous	EL	Television Conduit	TV
Emulsified Asphalt Materials	EAM	Top Soil	TS
Emulsified Treated Base	ETB	Type A Inlet	AI
Field Inlet	FI	Unclassified Excavation	EX
Filter Blanket	FB	Useable Excavation, Type (A, B, C)	EX()
Filter Material	FM	Waste	EXW
Fire Hydrant	FH	Water Conduit	WC
Foundation Fill	FF	Waterline	WL
Gabion Backfill	GB	Warm Mix Asphalt	WMA
Types of Tests			
Correction Factor - Ignition Oven	CF	Mix Design	MD
Field Density	D	Moisture	M
Fracture Count	F	Oil Content	O
Gradation	G	Plastic Index	PI
Joint Density	DJ	Plastic Limit	PL
Mat Density	DM	Strength (Concrete)	S
Liquid Limit	LL	Standard Density	SD

This page intentionally left blank.