

MEMORANDUM

State of Alaska
Department of Transportation & Public Facilities
Northern Region Preconstruction

TO: Sarah Schacher, P.E.
Engineering Manager
Northern Region

THRU: Kevin Maxwell *KFM*
Regional Engineering Geologist
Northern Region

FROM: Tim Weiss *TW*
Engineering Geologist
Northern Region

DATE: April 6, 2015

FILE NO: H:\preconstruction\Support_Materials\Projects\working\highways\Dalton \Dalton 0-9\report\2014 Prelim memo for design.doc

TELEPHONE NO: 458-6883

FAX NO: 451-2353

SUBJECT: Dalton Highway MP 0 to 9
Realignment Project.
Preliminary Geotechnical
Investigation Memo
AKSAS 60911

Introduction

This memorandum is a preliminary draft intended to assist designers for planning, pre-environmental and preliminary design purposes. It is not to be included in, or attached by appendix to, any published final documents, nor referenced in the Notice to Bidders. A final geotechnical memo or report will be prepared at a later date.

The Alaska Department of Transportation and Public Facilities (ADOT&PF) Northern Region design engineers are planning to realign the Dalton Highway from Milepost 0 to 6. The project consists of realigning the Dalton Highway from its current start at milepost 0 to near the West Folk of the Tolovana River approximately 4,800 feet south on the Elliott Highway. The new alignment will run approximately five miles west along the north side of the Tolovana River Valley to approximately Lost Creek, then turn north along the west side of Lost Creek for approximately two miles and then meet back with the existing Dalton Highway at Milepost 6.2 (Figure 1). The realignment is proposed to be a gravel surfaced road.

Additional design considerations for the project include:

- A smooth transition from the existing Elliott Highway near MP 72.6 to the new alignment with newly constructed curves.
- Reconstruction of the existing Dalton Highway from Milepost 6 to 8.5 consists of road widening and grade adjustments.
- Estimated embankment material needed for the project is approximately 1.3 million cubic yards or more.

To assist with planning, Northern Region's Material Section (NRMS) personnel conducted a geotechnical investigation along the proposed realignment corridor, proposed curves to transition the Elliott Highway to the new alignment, and existing Dalton Highway from MP 6 to 8.5.

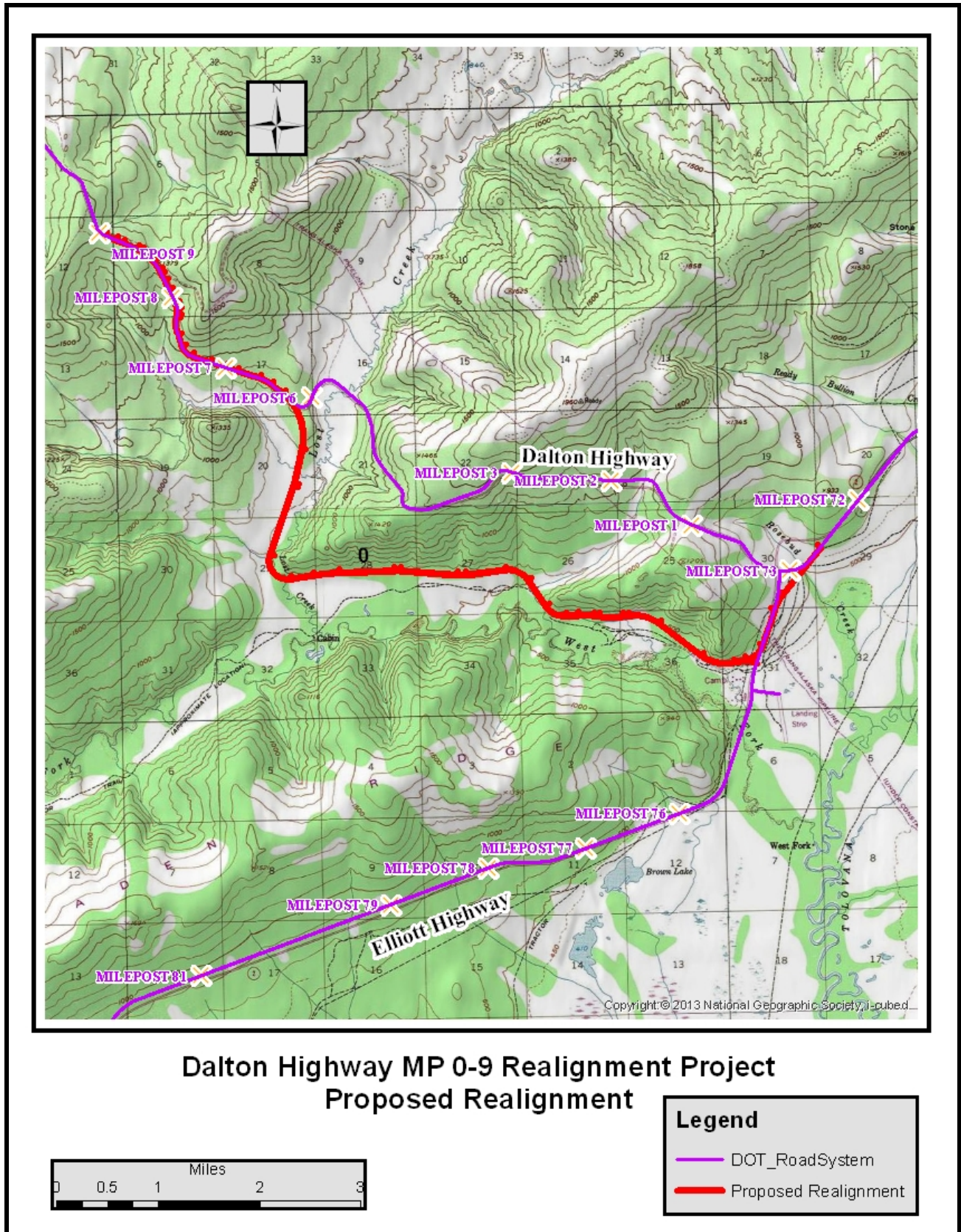

Figure 1: Project Location Map, Dalton Highway Realignment Project MP 0 to 9. Red line is realignment portion of project.

The purpose of this investigation was to characterize the subsurface soil conditions and recommend design considerations for the project. The investigation included:

- Drilling a total of 121 test holes for the realignment area. Test holes were located approximately 200- to 400-feet between holes, up to 10-feet left or right of the proposed centerline, and drilled from 15- to 27-feet in depth.
- Drilling a total of 19 test holes for the proposed two road curves from approximately MP 72.6 of the Elliott Highway to the proposed realignment.
- Drilling a total of 21 test hole along the existing Dalton Highway from MP 6.2 to 8.5.
- Drilling eleven test holes for a borrow source along the new realignment.
- Drilling three water monitoring wells at two locations.
- Installing one temporary and two long-term thermistors to monitor subsurface temperatures.
- Collecting a total of approximately 574 soil samples for laboratory testing.
- An Ohm-Mapper ground resistivity survey of the proposed realignment and the portion of the existing Dalton Highway within the project limits was completed by the US Army Cold Regions Research Laboratory.

Summary

Drilling along the proposed realignment generally encountered ice-rich silt overlying frozen sand or gravel. The thickness of the silt varied from 1-foot to more than 20-feet thick, and the visible ice content was zero to well over 75 percent. Massive ice was encountered along the hill leading to the existing Dalton Highway. Silt material in some locations was also high in organics, with some peat zones within the silt. Figure 2 below indicates areas along the realignment with ice-rich silt greater than 8-feet thick. A mile long segment north of Lost Creek appeared to have the greatest ice-rich silt or ice wedges. Figures 3 and 4 indicate the results of the Ohm-Mapper resistivity survey for the realignment portion only. These figures are in general agreement with drilled test hole results and Figure 2.

Drilling encountered sandy material along the proposed realignment from approximately ½- mile to 2-miles east of Lost Creek (Station 270+00 to 320+00). Additional drilling in the area indicated a possible significant quantity of sand with gravel that could be used as borrow material for construction of standard embankment sections.

Overall the realignment area is highly variable from a geologic and geotechnical perspective; therefore, design recommendations will be considered for specific segments of the new alignment. The intent of this memorandum is to give generalized broad recommendations that will be refined with collection of additional drilling data and finalization of the alignment.

Drilling at the first proposed curve near the beginning of the project, Elliott Highway MP 72.5, encountered generally very loose to loose, thawed silt or clay from near the surface to depths of approximately 7- to 9-feet. The soil transitions to frozen and ice-rich near the creek at the Elliott Highway. Some test holes encountered highly weathered bedrock underlying silt or clay to depths explored. The second proposed curve joining the existing Elliott Highway near MP 74 to the proposed realignment, encountered generally thawed, highly-weathered bedrock material.

The proposed realignment will require at least one bridge crossing at Lost Creek. Foundation drilling for the proposed bridge crossing was not a part of this investigation.

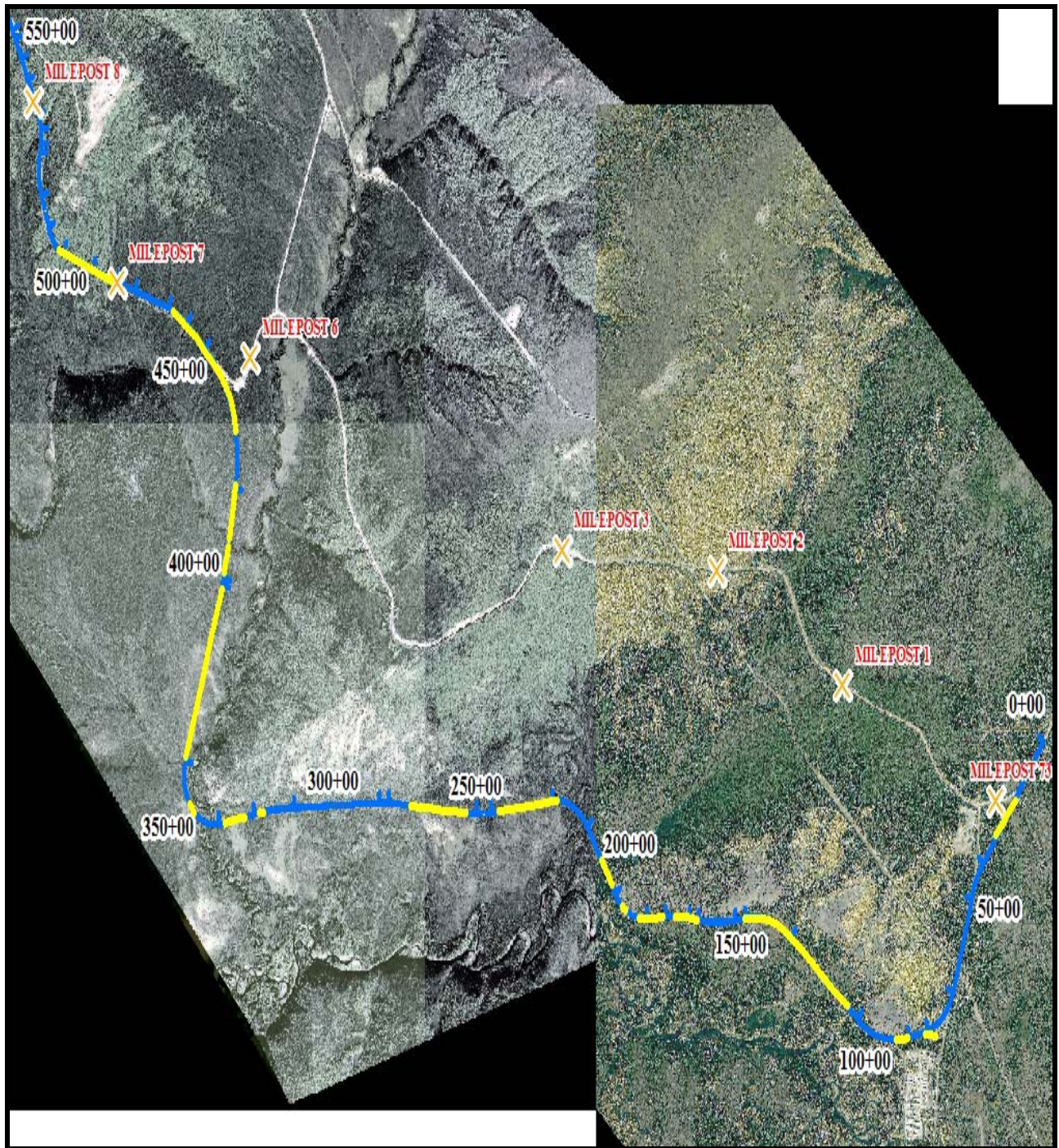

Figure 2: Dalton Highway Realignment Project MP 0 to 9. Proposed realignment and reconstruction, with yellow representing those areas with ice-rich silt greater than 8-feet thick. These areas represent approximately 42 percent of the project. Map is based on drilled test hole information only.

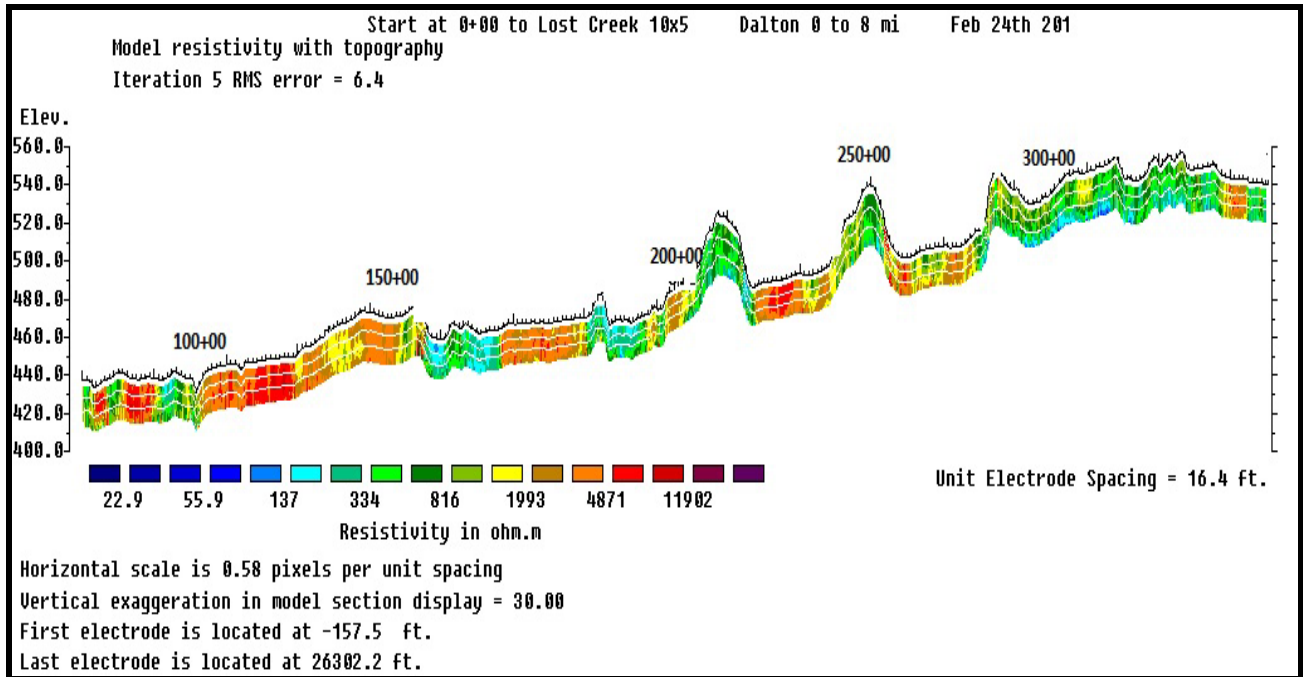

Figure 3: Dalton Highway Realignment Project MP 0 to 9. Ohm-Mapper resistivity survey results from Elliott Highway to Lost Creek (approximately Stations 76+00 to 340+00). Hot colors (orange and red) indicate ice-rich subsurface soils and cool colors (blue and green) indicate ice-poor subsurface soils in those areas indicated. Survey also indicates topography.

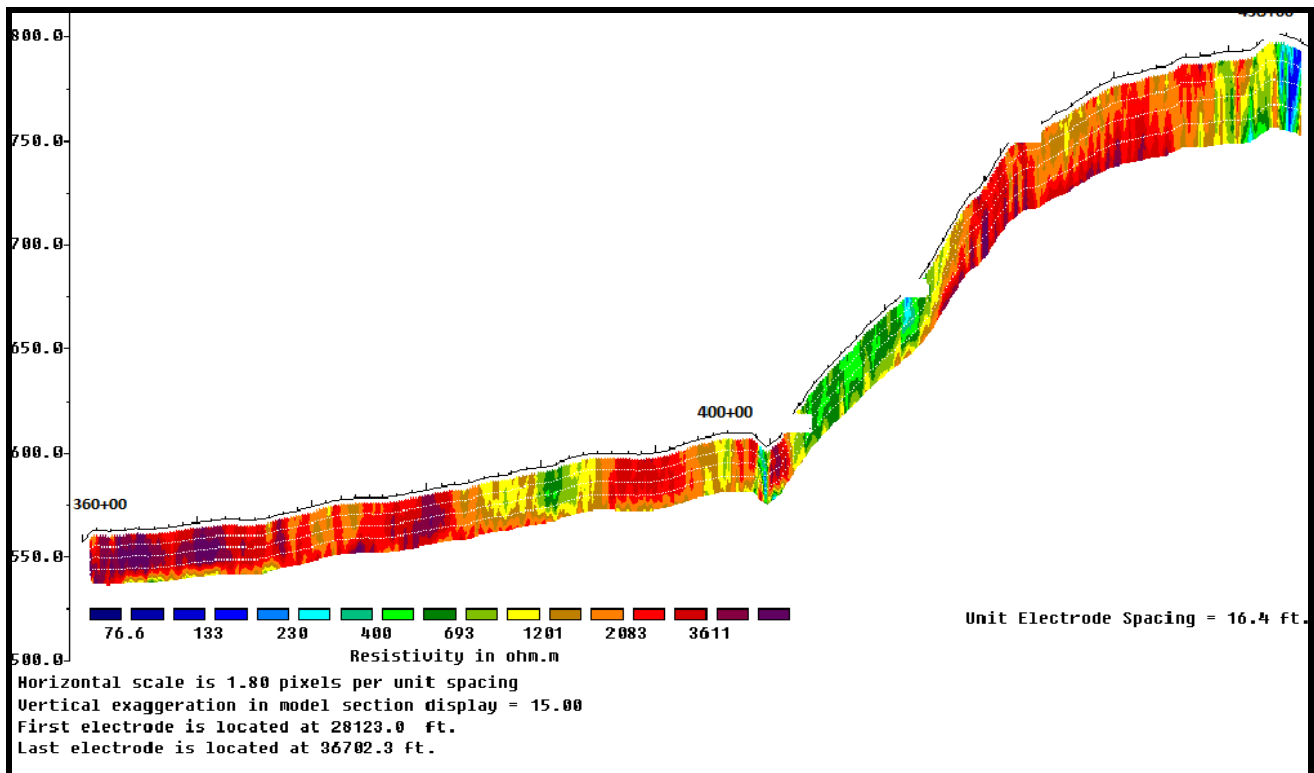

Figure 4: Dalton Highway Realignment Project MP 0 to 9. Ohm-Mapper resistivity survey results from near Lost Creek to Dalton Highway MP 6.2 (approximately Stations 360+00 to 450+00). Hot colors (orange and red) indicate ice-rich subsurface soils and cool colors (blue and green) indicate ice-poor soils in those areas. Survey also indicates topography.

Field Investigation

The field investigation was conducted in two phases with the first taking place from February 21st thru April 5th, 2014, and the second from July 22nd to August 1st, 2014. A track mounted CME 850X drill rig equipped with 6-inch solid stem and 6.5-inch hollow stem augers was used to drill the test holes during both periods. The crews consisted of drillers S. Parker, P Lanigan, G. Nelson, M. Sousa, and engineering geologist T. Weiss. Drilling and test hole conditions were logged in the field using the Unified Soil Classification System (USCS).

Most soil samples were collected directly from solid stem auger cuttings. Twenty-nine test holes were drilled with hollow stem augers, with relatively undisturbed samples collected from a split spoon sampler and Standard Penetration Test (SPT) blow counts recorded. The SPT sampler is driven with a 140-pound auto-hammer over an interval of 2-feet. Soil temperature readings were recorded with a hand held digital probe and recorded on the logs in degrees Fahrenheit. The recorded temperatures from solid stem augers are approximate.

Laboratory analysis of the samples was conducted by the Northern Region Materials Laboratory (NRML). The testing program included; grain size analyses, classification, moisture and organic contents, and quality related testing including; LA abrasion, degradation, and sodium sulfate soundness. Additional laboratory testing was performed by outside labs. Frozen soil unit weight testing was performed by Shannon and Wilson Inc., and thaw consolidation testing by Dowl HKM Inc. The test holes were located using a hand held Global Positioning System (GPS) Garmin GPS 62s model using the North American Datum (NAD) 83. The accuracy of the GPS is plus or minus 50-feet. After drilling all test holes were backfilled with auger cuttings.

Preliminary Expected Physical Site Conditions

- Expect the distribution of frozen soils to vary from those presented. The distribution of frozen soils is climate and season dependant.
- Massive ice was encountered in some test holes and could be present at areas not explored.
- Expect water table elevations to fluctuate from those shown in this report. The water table generally fluctuates in response to changing river levels and precipitation.
- Expect perched groundwater on top of frozen layers.
- Expect thawing of ice-rich soils when excavated or after removal of the organic mat.
- Expect pumping of silt soils at the bottom of excavations.
- Expect difficulty handling moist or wet silty soils.

Generalized Site Description

The project is approximately 10-miles in length over undeveloped terrain and existing highway, and includes a variety of subsurface soil conditions. The proposed realignment portion of the project is over undeveloped terrain that starts at the Elliott Highway near MP 74.1 and progresses west along the Tolvana river valley to Lost Creek. The terrain through this section varies from sparse stunted black spruce trees to thick willow and large spruce, and from relatively flat areas to moderate hill slopes and uneven river flood plains. At Lost Creek, the proposed realignment turns north and gradually to moderately climbs in elevation toward the

Dalton Highway MP 6.2. Two unnamed small creeks are crossed through this section with the lower creek being deeply incised with steep side slopes.

Thaw Strain of Frozen Materials

Selected samples of frozen foundation soils were obtained from split-spoon samples and preserved for laboratory testing. Twenty six samples were delivered to Shannon and Wilson in Fairbanks for determination of bulk frozen density and frozen dry density to allow for estimation of volumetric moisture (ice) content and thaw strain. Four samples were also sent to DOWL HKM in Anchorage for thaw consolidation testing to determine thaw strain.

The results of the thaw strain testing were 13 and 53 percent consolidation for ice-poor silt with natural moisture contents of 44 and 47 percent respectively, and 30 and 63 percent consolidation for more ice-rich silt with natural moisture contents of 109 and 142 percent respectively.

The results of fifteen silt samples tested for bulk frozen density and dry density, resulted in estimated thaw strain ranging from 0 to 15 percent moisture for ice-poor silt and 55 to 60 percent moisture for ice-rich silt.

Preliminary Thermal Modeling Methods, Results and Embankment Design Considerations

The major geotechnical issue for the Dalton Highway MP 0 to 9 project is the presence of ice-rich foundation soils and ice-wedges. In order to determine the acceptable embankment geometry and construction methodology to mitigate the potential thaw-settlement of these ice-rich soils, NRMS personnel conducted preliminary thermal modeling using GEO-SLOPE TEMP/W, a finite element program.

The basic approach to thermal modeling is to establish model geometry and material types, material physical and thermal properties, boundary conditions in the form of air temperature versus time, modifying factors to estimate ground surface temperatures from air temperatures, and a constant temperature at the bottom of the model. The subsurface profile was developed based on exploratory drilling along the realignment route. The typical subsurface profile, approximated from the top down, is the following:

- 1.0-foot Organic Material,
- 9.0-foot Very Ice-rich Silt,
- 6.0-foot Ice-rich Silt,
- Sand and Gravel from 16.0-feet to an unknown depth.

The modeled embankment was assumed be 8-feet in height, 36-feet in width, with 3:1 side slopes, and assumed to be conventional construction consisting of Select Material, Type A and borrow.

The next step in the modeling process was to establish temperature boundary conditions. The model lower boundary condition was set as a fixed temperature based on temperature profiles from a nearby University of Alaska Fairbanks permafrost monitoring borehole. For the upper boundary or surface boundary condition, an air temperature versus time function was required. The average daily air temperature for Livengood, AK was obtained from historic air temperature data from the

National Climate Data Center. This data was used to input daily temperatures in the model over a 100 year time frame.

After inputting the air temperature function into the model, it was then necessary to add modifier functions for each surface condition. N-factors derived from published sources were used to generate modifier functions relating air temperature to ground surface temperature. A primary consideration is the assumption that snow on the roadway would be removed during the winter months and pushed to the sides of the roadway, thereby increasing the snow cover on the side slopes of the embankment. Physical and thermal properties of each of the material types used in the model were also estimated and input into the model.

The model without the road embankment was run to allow ground temperatures to reach a state of equilibrium. Ground temperatures versus depth were plotted and compared to actual ground temperatures from the nearby permafrost monitoring test holes. Tundra N-factors were adjusted until the model results approximated actual measured ground temperatures.

The final step in the establishment of thermal boundary conditions was the development of estimates for future air temperatures. Permafrost and mean annual air temperatures have increased in Alaska over the last several decades. The 2050 projected air temperature estimates were obtained from the University of Alaska Fairbanks International Arctic Research Center's Scenarios Network for Alaska, and Arctic Planning (SNAP) for the Mid-Range Emissions Climate Model for Livengood, Alaska.

A model with no embankment, consisting of only the organic mat and foundation soils, was run for 10 years in order to obtain equilibrium ground condition temperatures. A model embankment with a gravel surface, with and without insulation board at the bottom was then placed on the ground surface on August 1st. Each configuration model was then run with the newly constructed embankment, through the end of that year, and then for an additional 11 years. This was done to obtain equilibrium conditions in order to determine the maximum thaw depth assuming no thaw settlement. Each embankment configuration was then run for 11 years using climate temperature projections for 2050, in order to determine the maximum thaw depth assuming no thaw settlement for projected future climate temperatures.

The model results indicate the typical active layer thickness in the project area is approximately 2.4-feet. This corresponds well to the typical active layer thicknesses from test holes drilled in undisturbed areas over ice-rich soils. The active layer was estimated to increase to 2.8-feet in depth for the 2050 temperature projections. Model results are shown below in Figures 5 and 6.

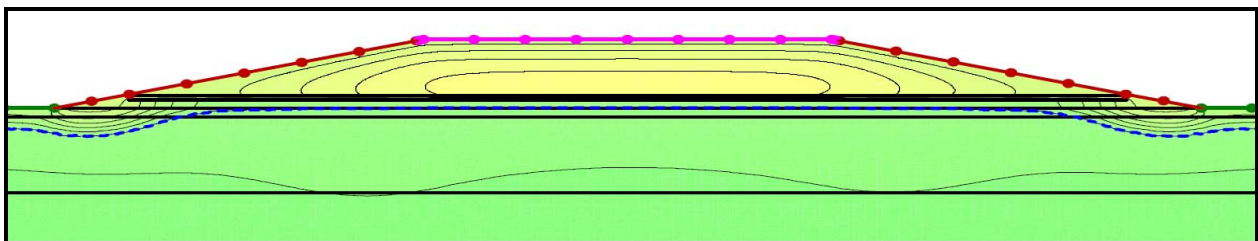

Figure 5: Eight foot embankment with 6-inches of insulation board under historic temperatures. Maximum depth of thaw occurs approximately during the last week in September. Dashed blue line is the 32 degrees Fahrenheit isotherm.

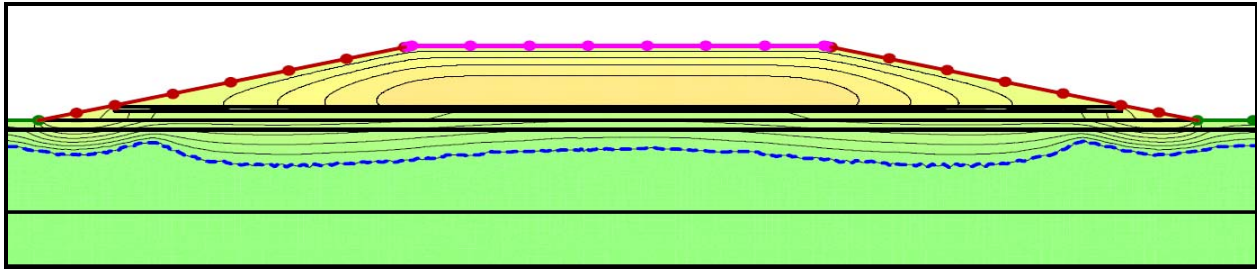

Figure 6: Eight foot embankment with 6-inches of insulation board under projected 2050 temperatures. Maximum depth of thaw occurs approximately during the last week in September. Dashed blue line is the 32 degrees Fahrenheit isotherm.

Model Results Tabulation and Discussion

Modeled ground temperatures versus depth data was developed for the centerline of the embankment, the toe of the structural core of the embankment, and the area of maximum thaw depth under the toe of the side slopes. The depth of maximum annual thaw for each of these locations within or below the embankment was determined for each embankment configuration under both historic and projected 2050 air temperatures, results are shown in Table 1. The maximum depth of thaw occurs during the last week in September.

Thermal stability for an embankment configuration is defined as one in which the maximum depth of thaw under the structural toe of the embankment (1H:1V projection from the edge of road shoulder) does not progress deeper than the original ground surface.

Table 1: Thermal Modeling Results.

Model Configuration all are 8-foot embankment and gravel surface	Maximum depth of thaw below centerline (feet)	Maximum depth of thaw below 1H:1V structural toe (feet)	Maximum depth of thaw below toe of slope (feet)	Depth of Active Layer (feet)
historic temperatures, no insulation	1.3	2.0	3.4	2.4
historic temperatures with 6-inches insulation board	0.0	0.1	3.5	2.4
future temperatures, with 6-inches insulation board	3.3	5.0	3.8	2.8

The 8-foot embankment without insulation board, was not thermally stable under historic air temperatures. The 8-foot embankment, with 6-inches of insulation board, was marginally thermally stable under historic temperatures, but was thermally unstable for projected 2050 temperatures.

The historic air temperature record was used to determine the air freezing and air thawing indices for Livengood, and the Air Convection Embankment (ACE) Design Guide (Alaska DOT&PF, McHattie and Goering, 2009) was used to evaluate ACE embankment design considerations for this project. It

was determined that a minimum ACE embankment thickness of 5-feet would adequately maintain freezing temperatures in the foundation soils under an ACE embankment near Livengood.

Based on the preliminary thermal modeling results:

- 1) Construction of a conventional fill embankment will not be thermally stable and will result in unacceptable thaw settlement where constructed over ice-rich foundation soils.
- 2) Construction of a conventional fill embankment with insulation board will not be thermally stable under projected 2050 temperatures and will result in unacceptable thaw settlement where constructed over ice-rich foundation soils.
- 3) Construction of an Air Convection Embankment is recommended for road segments constructed over ice-rich foundation soils.
- 4) Additional thermal modelling will be conducted using ground temperatures measured in test holes along the realignment and more detailed embankment design recommendations will be provided in a future final geotechnical report.

Preliminary Comments and Recommendations

The intent of this memorandum is to give generalized recommendations based on the results of this investigation with more specific recommendations to follow in a final memo or report. These generalized recommendations are based on the above thermal modeling discussion and segments shown in Figure 2. The figure indicates in yellow those areas of the project with ice-rich silt greater than 8-feet thick. These areas represent the highest level of geotechnical design consideration and the greatest long-term threat to stability of standard embankments, being those areas most likely to experience significant thaw settlement due to degrading permafrost. Those areas with ice-poor foundations or ice-rich material less than 8-feet thick, are considered less susceptible to significant thaw settlement and thus require a lower level of geotechnical design consideration. Based on Figure 2, a generalized approximate station to station geotechnical design summary is given below in Table 2.

Table 2: Generalized approximate station to station geotechnical design recommendation summary.

Station to Station	Geotechnical Concern or Foundation Condition	Preliminary Design Recommendations	Additional Comments and Considerations
0+00 to 20+00	Thawed, wet, loose soils at culvert	Multiple layers of reinforcement geotextile in culvert foundation and road embankment near culvert.	
20+00 to 26+00	Ice-rich silts, thaw unstable	ACE embankment.	

Station to Station	Geotechnical Concern or Foundation Condition	Preliminary Design Recommendations	Additional Comments and Considerations
26+00 to 50+00	Thawed, loose fine grained soils	4-foot embankment with reinforcement geotextile at bottom.	
50+00 to 75+00	Thawed, loose fine grained soils	Raise embankment to grade.	
75+00 to 85+00	Highly Weathered Bedrock	Bring embankment to design grade. Cut areas, material is useable as Select Material Type C	Right and left side slopes most likely stable
85+00 to 90+00	Ice-rich silts, thaw unstable	ACE embankment.	
90+00 to 110+00	Thawed fine or coarse grained material	4-foot embankment with reinforcement geotextile at bottom.	
110+00 to 150+00	Ice-rich silts, thaw unstable	ACE embankment.	
150+00 to 200+00	Variable thawed and Ice-rich fine to coarse grained material	10-foot embankment with reinforcement geotextile fabric at bottom and multiple layers of geotextile within embankment. Potential use of Insulation Board.	Right side slopes may have unstable ice-rich silts, some are stable bedrock.
200+00 to 225+00	Frozen Ice-poor silt or sand	4-foot embankment with reinforcement geotextile at bottom. Right side slopes most likely stable.	Cut areas, material is useable as Select Material Type C
225+00 to 240+00	Ice-rich silts with organics, thaw unstable	ACE embankment.	Right side slopes may have unstable ice-rich silts.
240+00 to 255+00	Frozen Ice-poor silt or sand	4-foot embankment with reinforcement geotextile at bottom. Right side slopes most likely stable.	Cut areas, material is useable as Select Material Type C.
255+00 to 275+00	Ice-rich silts with organics, thaw unstable	ACE embankment.	
275+00 to 325+00	Frozen Ice-poor sand	4-foot embankment, right side slopes most likely stable.	Cut areas, material is useable as Select Material Type B or C.
325+00 to 360+00	Variable ice-poor to ice-rich silts	ACE embankment.	Two or three Creek Crossings.
360+00 to 450+00	Ice-rich silts with organics, ice wedges, thaw unstable	ACE embankment.	Right or left side slopes unstable ice-rich silts.

Station to Station	Geotechnical Concern or Foundation Condition	Preliminary Design Recommendations	Additional Comments and Considerations
450+00 to 500+00	Existing road, Ice-rich silts with organics, ice wedges, thaw unstable	Potential ACE embankment side slopes and/or insulation board and multiple layers of reinforcement geotextile.	Right side slopes unstable ice-rich silts.
500+00 to 550+00	Thawed or frozen ice-poor sands, silt or bedrock	4-foot embankment, right side slopes most likely stable.	Cut areas, material is useable as Select Material Type B or C.

The geotechnical design recommendations given above are generalized and could change significantly once more specific design considerations are analyzed.

Below are selected photographs beginning at station 25+00 and proceeding west and north along the project to the existing Dalton Highway near MP 8. Some of these photos include a description of potential geotechnical considerations or subsurface soil conditions.



Figure 7: Existing utility easement near Rose Bud Creek and station 25+80. Photo is looking east with the Dalton Highway embankment to the left. The fiber optic excavation experienced approximately 3- to 4-feet of thaw settlement over a period of approximately two months in 2014.



Figure 8: Proposed realignment near station 77+43. Photo is looking southwest at high ground composed mostly of highly weathered bedrock in a probable cut area. Photo is taken within a small material site excavation.



Figure 9: Proposed realignment near station 81+90. Photo is looking west along existing small access road. The access road starts at the Elliott Highway and travels west approximately 1-mile before come to a dead end.



Figure 10: Proposed realignment near station 116+80. Photo is looking northwest at the alignment to the left of the photo and hills bounding the alignment to the north. Drilling indicated ice-rich subsurface soils in this area.



Figure 11: Proposed realignment near station 167+57. Photo is looking east with a hill slope to the left and low drainage area to the right. The hill slope could have unstable ice-rich silt material near the surface. Drilling indicated thawed soils underlying seasonally frozen soils in this area of the alignment.



Figure 12: Proposed realignment near station 182+20. Photo is looking west. Drilling in this low lying area indicated ice-rich subsurface soils.



Figure 13: Proposed realignment near station 194+66. Photo is looking east at the east-ridge bedrock outcropping.



Figure 14: Proposed realignment near station 206+52. Photo is looking to the west and up a gradual slope toward a hill. Drilling in this area indicated ice-poor subsurface soils.



Figure 15: Proposed realignment near station 224+15. Photo is looking west at abrupt change from wooded hill slope area to flat low-lying open area. Drilling indicated wooded high ground areas generally consisted of ice-poor sand or silt, while flat low-lying open areas consisted of ice-rich soils.



Figure 16: Proposed realignment near station 245+93. Photo is looking west at wooded hill area. Drilling in this area indicated frozen ice-poor sand or silt subsurface soil.



Figure 17: Proposed realignment near station 278+09. Photo is looking west at abrupt elevation change or bench located in the middle background. The change is also a transition between ice-rich and ice-poor surface soils.



Figure 18: Proposed realignment near station 303+85. Photo is looking east. Drilling in the area indicated ice-poor sandy subsurface soil.



Figure 19: Proposed realignment near station 332+00. Photo is looking east at low-lying area just east of Lost Creek. Drilling in this area indicated ice-rich subsurface soils.



Figure 20: Proposed realignment near station 340+00. Photo is looking west at an oxbow branch of Lost Creek, just north of the originally planned alignment crossing at Lost Creek.



Figure 21: Proposed realignment near station 358+00. Photo is looking west at an unnamed creek. The creek has a narrow thaw bulb and is deeply incised into silty soils at approximately 6- to 8-foot depth.



Figure 22: Proposed realignment near station 378+80. Photo is looking south. Drilling in this area indicated highly ice-rich subsurface silt soil.



Figure 23: Proposed realignment near station 406+65. Photo is looking south at 2nd unnamed creek. This second creek is smaller and not as deeply incised as the previous creek crossing.



Figure 24: Proposed realignment near station 412+16. Photo is looking north. Drilling in this area indicated ice-rich silt. The test hole just south of this location encountered an ice wedge.



Figure 25: Proposed realignment near station 429+19. Photo is looking north. Drilling encountered ice-rich silt, while two test holes drilled just to the south encountered ice-poor sand.



Figure 26: Existing Dalton Highway near station 458+50. Photo is looking southeast. The road has deep fills on the right and minor cut or fills on the left side. The ditch on the right is uneven ground with ponded water in some areas and drunken trees near those areas.



Figure 27: Existing Dalton Highway near station 467+00. Photo is looking northwest at north side ditch and side slopes at 7- to 10-feet higher in elevation than the road elevation. Drilling in the ditch at this location encountered highly ice-rich silts to 25-foot depth, indicating road widening in this area will cut into ice-rich side slopes.



Figure 28: Existing Dalton Highway near station 510+00. Photo is looking north at east ditch with a highly weathered bedrock slope at the vehicle pullout.



Figure 29: Existing Dalton Highway near station 537+00. Photo is looking to the north at east ditch side slopes. Test holes drilled on the slope encountered shallow thawed highly weathered bedrock.

Material Source Explorations

While exploring the proposed realignment from approximately station 275+00 to 320+00, drilling generally encountered seasonally frozen sand with gravel to depths explored. This area was found to have more sandy material than any other area along the proposed realignment. It was decided to add extra test hole locations to explore for a potential material source, these added test holes are shown below in Figure 30.

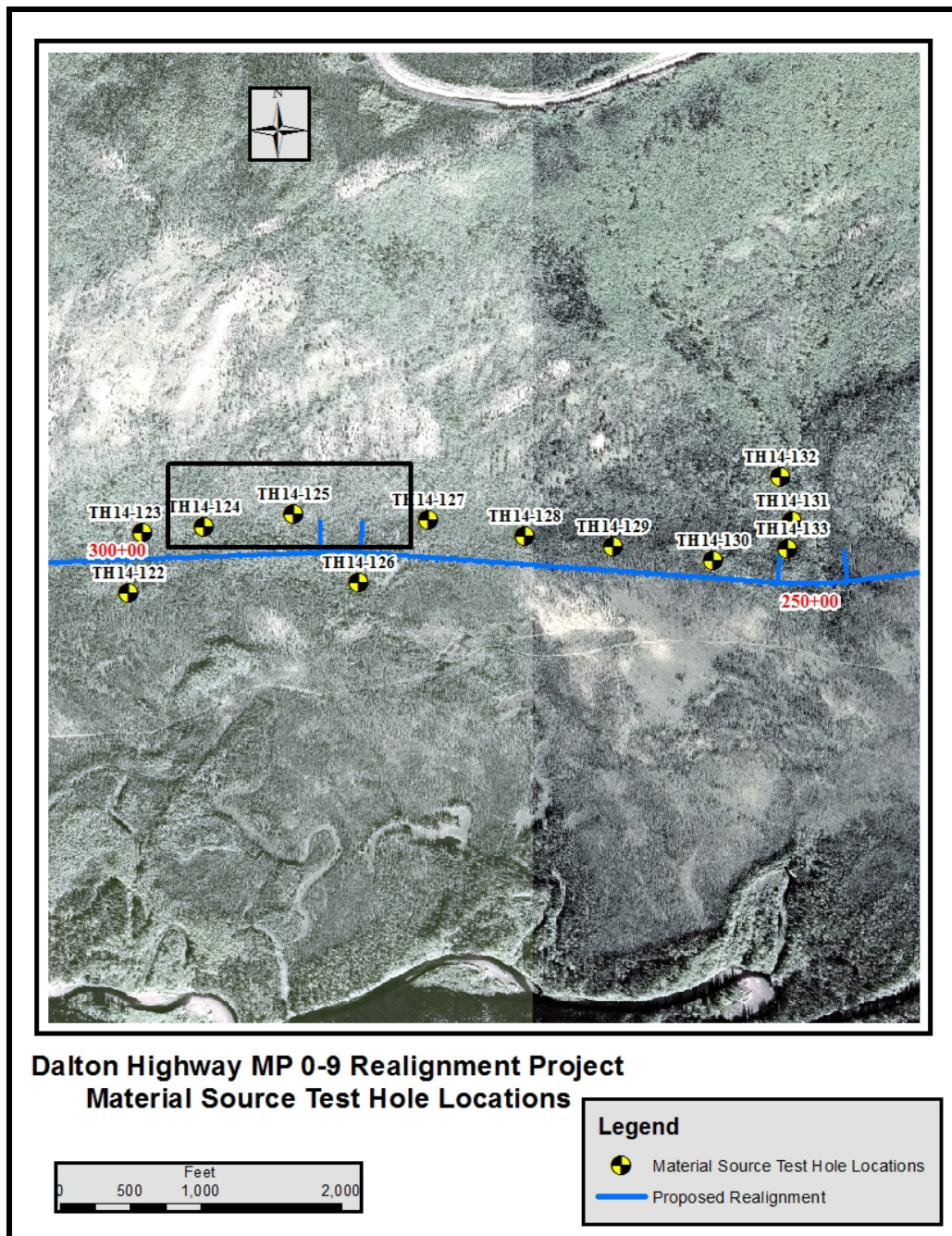

Figure 30: Dalton Highway Realignment Project MP 0 to 9. Potential material source test hole locations. The outlined rectangle is approximately 1,700-feet in length by 600-feet wide. Test holes drilled in the area encountered approximately 20-feet of sand with gravel. This rectangle area encompass 750,000 cubic yards of potential borrow material.

This exploration program resulted in the following, two test holes drilled south of the alignment (TH14-122 and TH14-126), encountered sand with gravel from 1-to 8-feet and 8.5-to 13-feet depth respectively. The four test holes drilled north of the alignment (TH14-123, TH14-124, TH14-125 and TH14-127), encountered significantly more potential borrow material than those test holes drilled south of the alignment. Laboratory testing indicated the material was generally classified as silty sand with gravel, with quality related testing of: LA abrasion loss 24, degradation value 67, and sodium sulfate soundness at 14.2 for the course fraction and 15.1 for fine fraction. These results meet standard specifications for Select Material Type C.

Three test holes located on “the bench” (TH14-128 thru TH14-130) were drilled for two purposes, first as another borrow material source, second as a potential alignment adjustment to the proposed realignment (Figure 31). These holes encountered sandy material from 2- to 21-feet in depth; indicating the “bench” is a better option to move the realignment away from ice-rich silt encountered on the original alignment and also an extension of the previously outlined borrow area encountered to the west.

Three test holes were also drilled at a second potential borrow area, TH14-131 thru TH14-133 (Figure 30). These holes were drilled on an alluvial fan, and generally encountered sandy silt or silty sand. Two of the three test holes encountered sandy material, TH14-131 from 5- to 24-feet in depth and TH14-132 from 2-to 15-feet in depth. Generally, these test holes for potential borrow material encountered higher silt content than other locations located to the west.

Table 3 below is a summary of subsurface soil conditions encountered from the potential material source test hole locations. This summary does not include those test holes drilled on “the bench” (TH14-128 to TH14-130); these are summarized in the next section discussing Alternate Alignment Five. The summary below includes selected laboratory test results.

Table 3: Summary of subsurface soil conditions for a potential material source near stations 245+00 to 300+00 of the realignment. Summary is arranged by increasing station.

Test Hole (TH)	Station and Offset	Silt Overburden and Depth (feet)	Sand or Gravel Material Depth (feet)	Frozen Soil Depth (feet)	Moisture Content (%) and Depth (feet)	Lab Gradation Results: Percent Passing #200 Sieve and Depth (feet)
14-131	250+60 449R	1.0 to 5.0	5.0 to 28.5	0.0 to 6.0	18.4% at 7.5 23.4% at 27.0	23.4% (7.0 to 11.0) 15.1% (18.0 to 22.0)
14-133	251+20 247R	1.0 to 10.0	10.0 to 12.5	0.0 to BOH*	None	None
14-132	251+80 755R	1.0 to 2.0	2.0 to 15.0	0.0 to 15.0 and 18.5 to BOH	16.4% at 10.0	65.4% (16.0 to 20.0)

Test Hole (TH)	Station and Offset	Silt Overburden and Depth (feet)	Sand or Gravel Material Depth (feet)	Frozen Soil Depth (feet)	Moisture Content (%) and Depth (feet)	Lab Gradation Results: Percent Passing #200 Sieve and Depth (feet)
14-127	276+58 285 R	1.0 to 2.0	2.0 to BOH*	0.0 to 6.0	18.5% at 7.5	22.1% (2.0 to 6.5) 30.7% (10.0 to 13.5)
14-126	281+57 210 L	1.0 to 8.5	8.5 to 13.5	0.0 to 6.0	None	18.1% (8.5 to 11.0)
14-125	286+00 280R	1.0 to 3.5	3.5 to BOH	0.0 to 6.0	4.2% at 22.0	27.8% (8.0 to 13.0) 17.5% (22.0 to 28.0)
14-124	292+46 210R	1.0 to 3.0	3.0 to 31.5	0.0 to 6.5	3.2% at 20.5	28.8% (4.0 to 8.0) 14.5% (13.0 to 17.0)
14-123	296+90 190R	1.0 to 2.5	2.5 to 24.0	0.0 to 9.0	4.0% at 11.0 7.3% at 21.0	17% (6.0 to 10.0)
14-122	298+00 238L	None	1.0 to 11.0	0.0 to 10.0	6.9% at 4.5	None

*BOH is Bottom of Hole.

Proposed Adjustments to Realignment Based on Exploration Results and Alternate Alignment Five

During exploration drilling of the proposed realignment, a suspected sand or gravel bench with an abrupt elevation change of approximately 8-feet was observed just north of the proposed realignment centerline at approximately station 250+00 to 275+00 (Figure 31). Three test holes (TH14-128 to TH14-130) previously drilled for a potential material source also served to explore the “bench”. Drilling on the bench confirmed sand and gravel material in the subsurface, and indicates “the bench” as outlined below in Figure 31 is a better alternative to the original realignment in order to avoid ice-rich silt foundation material.

A second potential realignment adjustment was observed on the hill leading to the existing Dalton Highway near MP 6.2 (Figure 32). The original proposed realignment runs along the north side of the hill from approximately station 420+00 to 440+00. Test holes drilled in the area generally encountered ice-rich silt foundation material except at three hole locations.

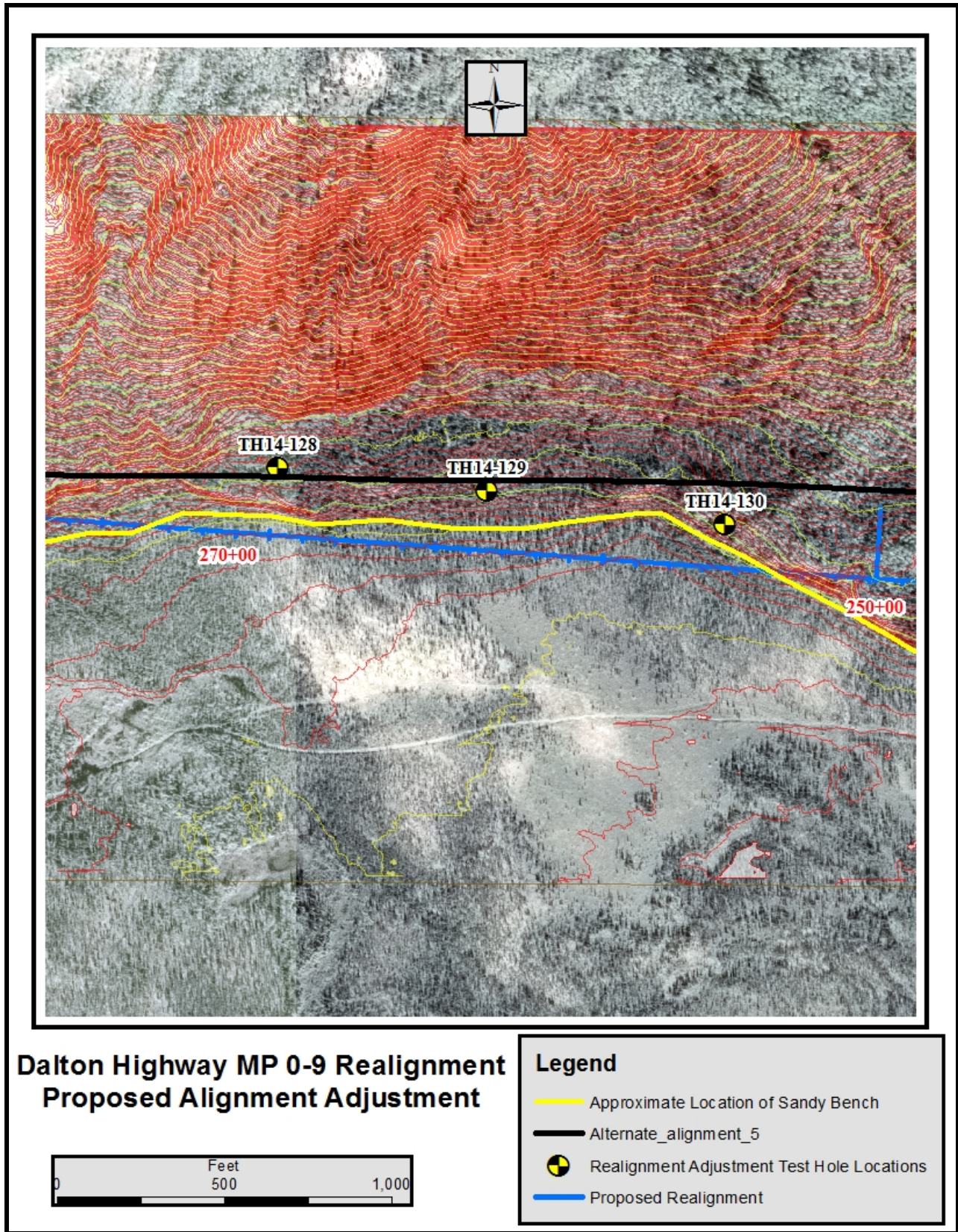

Figure 31: Dalton Highway Realignment Project MP 0 to 9. Realignment adjustment test hole locations. Yellow line represents the approximate location of the observed “bench”.

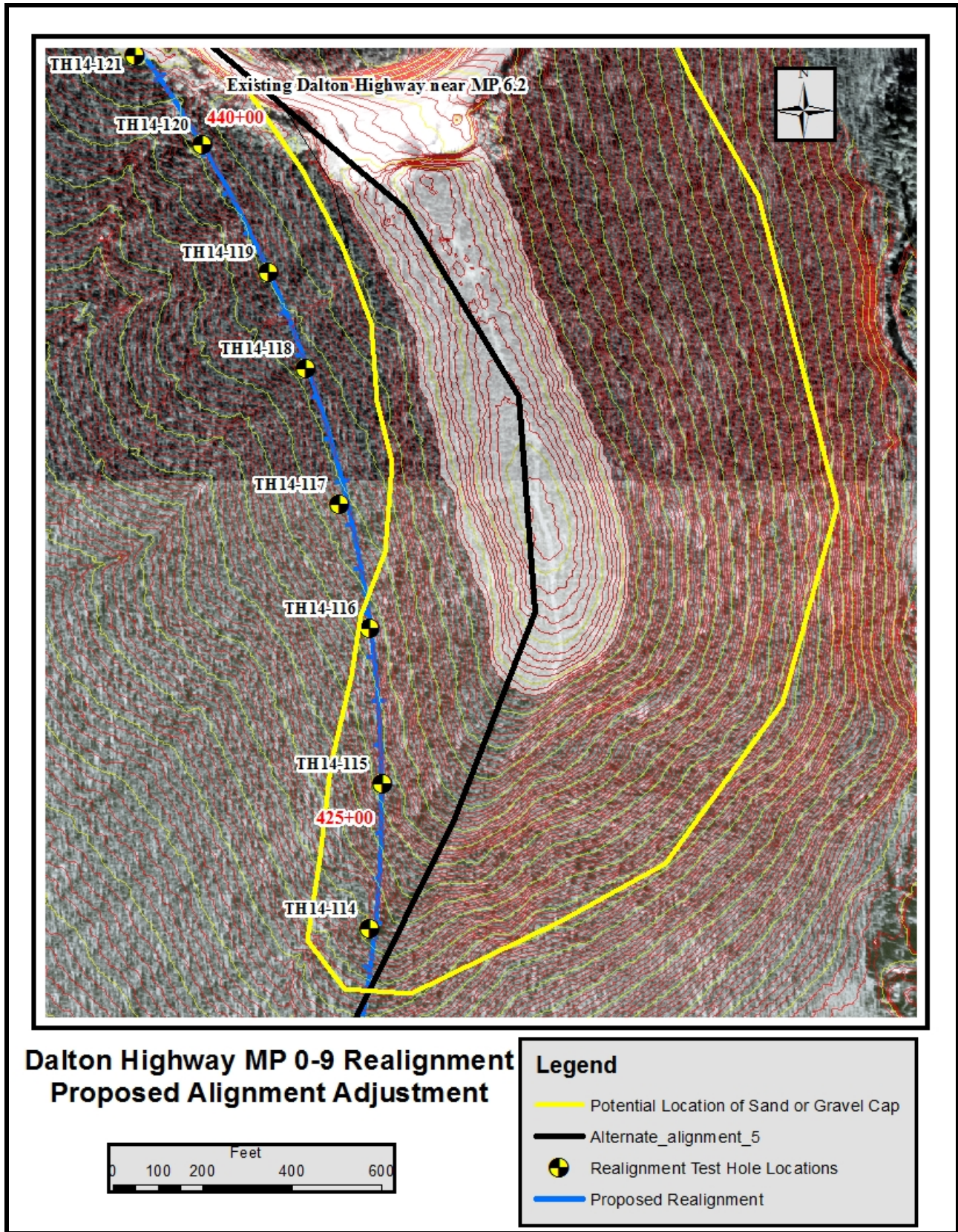

Figure 32: Dalton Highway Realignment Project MP 0 to 9, second proposed realignment adjustment. Yellow area represents the approximate location of a potential sand or gravel cap to the hill, including the three test hole locations that encountered the material.

These three test holes (TH14-114 to TH14-116) encountered sand and gravel to depths explored, and gravel material was observed in small excavations at the top of the hill. From these observations we propose a second adjustment to the original realignment.

Based on results of the overall realignment exploration program, realignment adjustment options were considered for other areas to avoid ice-rich silt material as much as possible. The primary focus was the more than 1-mile long area north of Lost Creek. In addition, a large ridge east of Lost Creek appeared to be composed of bedrock and sandy soil. Up to seven different road alternate alignments near Lost Creek were considered. From this analysis Alternate Alignment Five was chosen as the preferred alignment for road design considerations (Figure 33). Alternate Alignment Five also included the “bench” area, and the hill near the existing Dalton Highway as previously discussed.

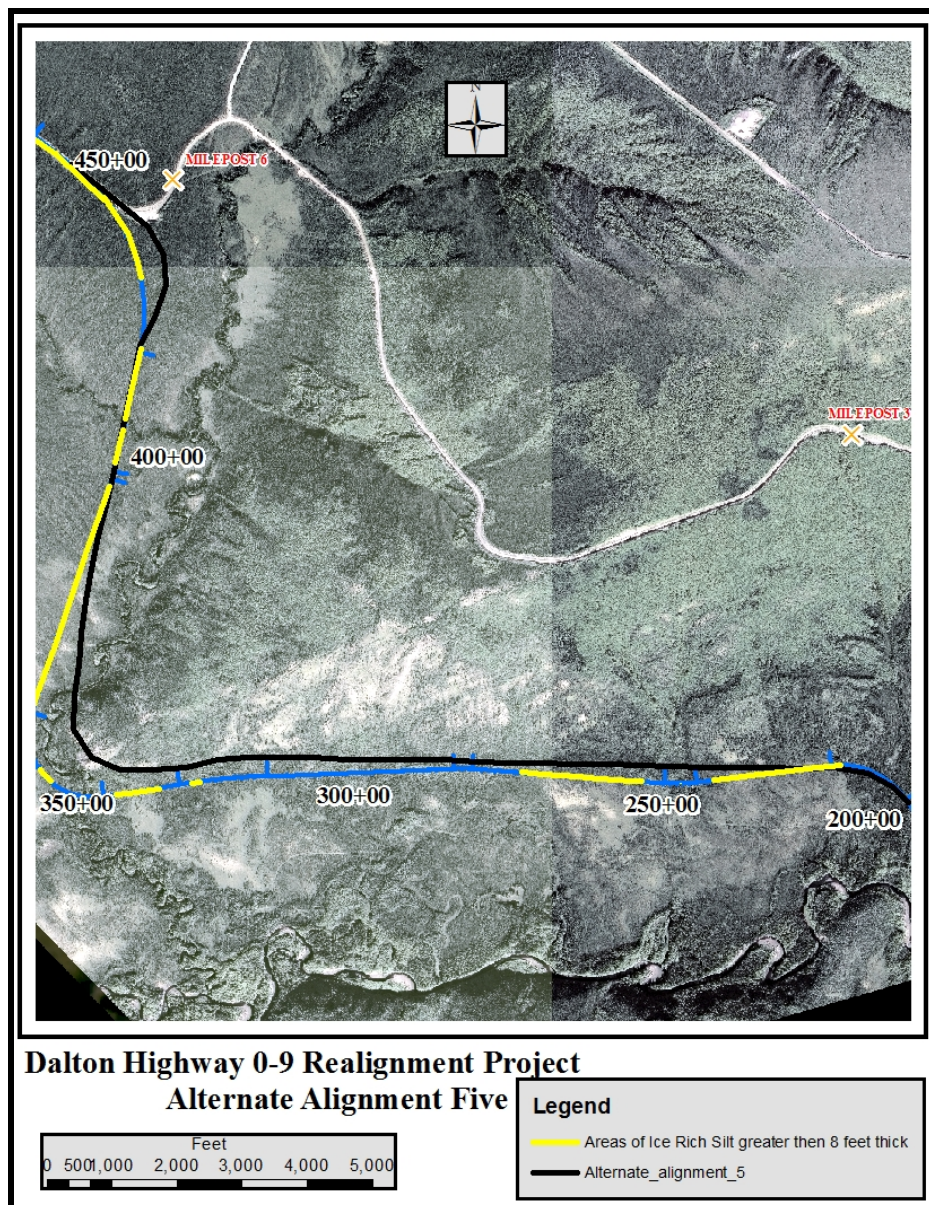

Figure 33: Dalton Highway Realignment Project MP 0 to 9. Proposed adjustment to original realignment, black line is preferred Alternate Alignment Five.

Based on the results of this investigation to date and pending additional drilling planned for the summer of 2015, Alternate Alignment Five has the following advantages from the original project realignment:

1. Alternate Alignment Five has the potential to eliminate approximately 5,000 feet of ice-rich foundation soils, and potential design considerations for those areas of an ACE embankment. This elimination is approximately 1,300-feet at the hill leading to the existing Dalton Highway (Station 428+00 to 440+00), 2,000-feet north of Lost Creek (Station 350+00 to 370+00), and 1,800-feet near “the bench” (Station 272+00 to 254+00).
2. Although most of Alternate Alignment five has not been drilled, indications are the alignment will be founded on mostly sandy material or bedrock. The exception is the proposed crossing at Lost Creek and north to the original realignment, where foundations soils are predicted to be ice-rich.
3. Cutting through the west ridge for Alternate Alignment Five will potentially generate borrow and material suitable for ACE embankment construction.
4. One or possibly two large culvert crossing will be eliminated with Alternate Alignment Five.

Disadvantages for Alternate Alignment Five are:

1. Elimination of some potential borrow material, as most of the area explored for borrow material is now occupied by Alternate Alignment Five; meaning additional areas may need to be explored for borrow. This depends on the amount of material generated by the alignment in planned cut areas.
2. Alternate Alignment Five is moving up onto higher ground from the original realignment, thus increasing the potential for unstable side slopes.
3. Alternate Alignment Five at the hill leading to the existing Dalton Highway at MP 6.2, may require a deep cut at the hill for required grade. This deep cut may eliminate all potential sand or gravel foundation material observed capping the hill. Planned drilling for the summer of 2015 will determine this scenario.
4. Most of Alternate Alignment Five has not been explored and any geotechnical or geological conditions at the new Lost Creek bridge location are not known.
5. If Alternate Alignment Five is chosen as the preferred final alignment, we recommend a slight adjustment near our current permanently installed thermistor location at station 384+86. We recommend the embankment be placed over the present thermistor installation location in order to avoid reinstallation if possible.

Based on the above discussion we recommend proceeding with Alternate Alignment Five as an alternate to the original alignment, pending the results of the planned drilling program in 2015.

Attachments:

- Test Hole Logs,
- Symbols and Definitions,

cc: Jeff Currey, P.E., Material Engineer
Steve McGroarty, P.E., Geotechnical Engineer
Jeff Stutzke, P.E., Hydrology Engineer; and Andrew Wells, Project Design Engineer.

TEST HOLE LOGS

STATE	PROJECT DESIGNATION	YEAR	SHEET NO.	TOTAL SHEETS
ALASKA	----	2017	----	####

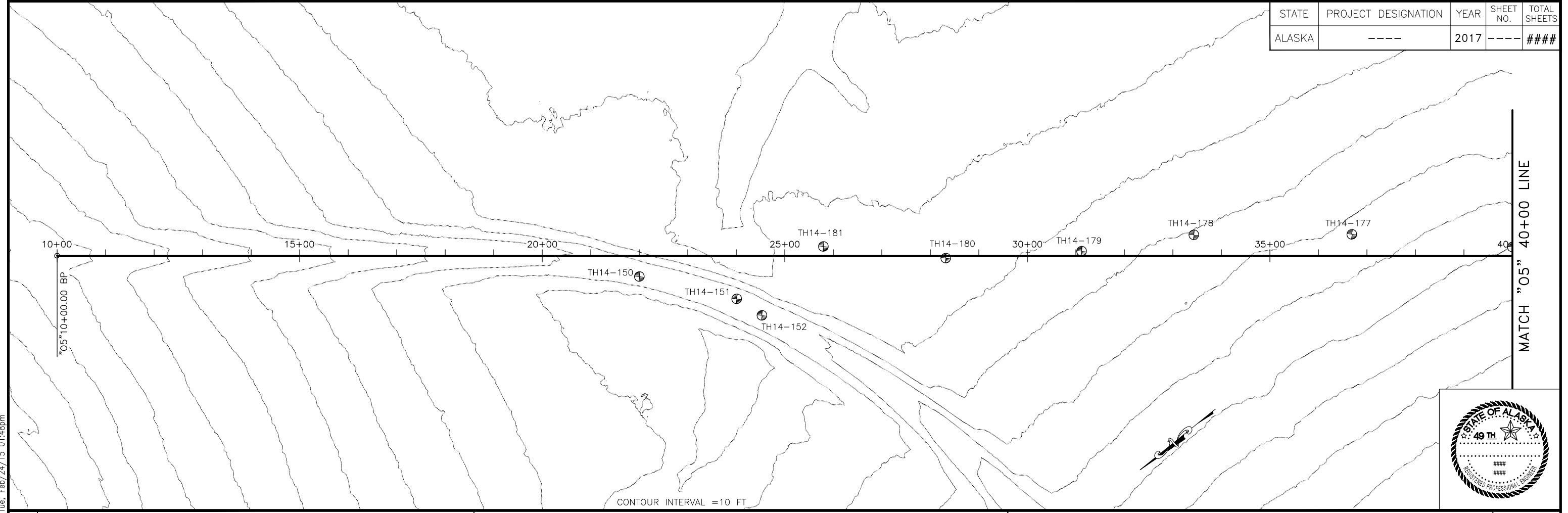

MATCH "05" 40+00 LINE

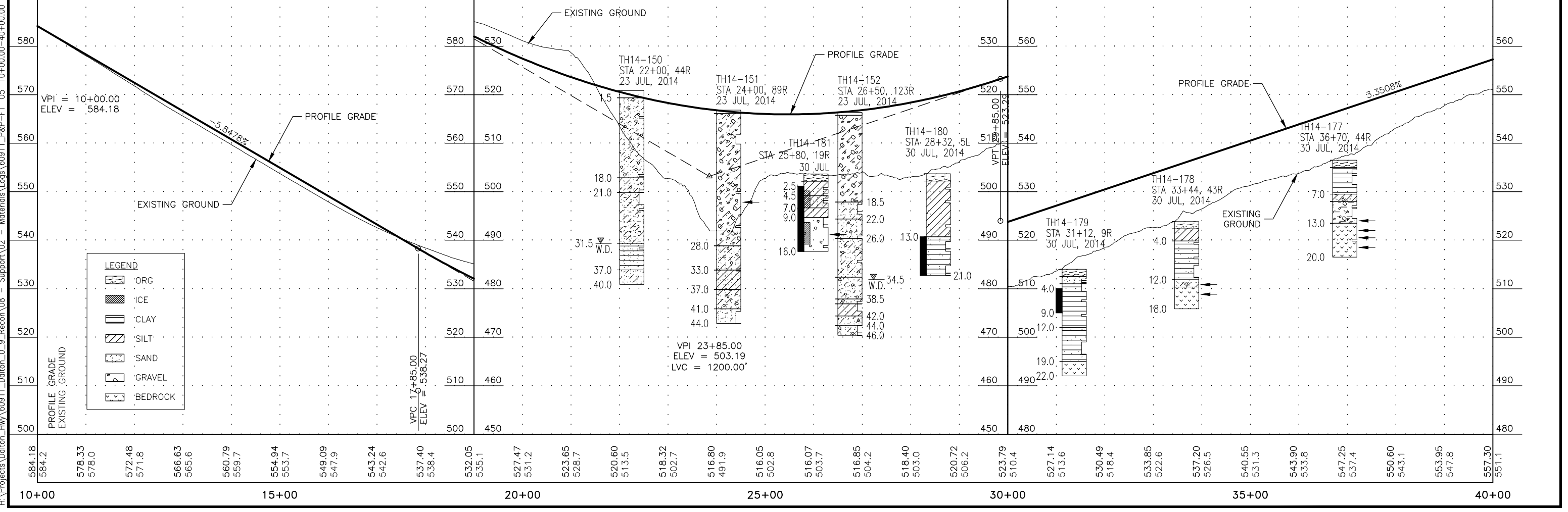

H:\Projects\Dalton_Hwy\60911_Dalton_0_9_Recon\08 - Support\02 - Materials\Logs\60911_P&P-F1 '05' 10+00.00-40+00.00 Tue, Feb/24/15 01:48pm

STATE	PROJECT DESIGNATION	YEAR	SHEET NO.	TOTAL SHEETS
ALASKA	----	2017	----	####

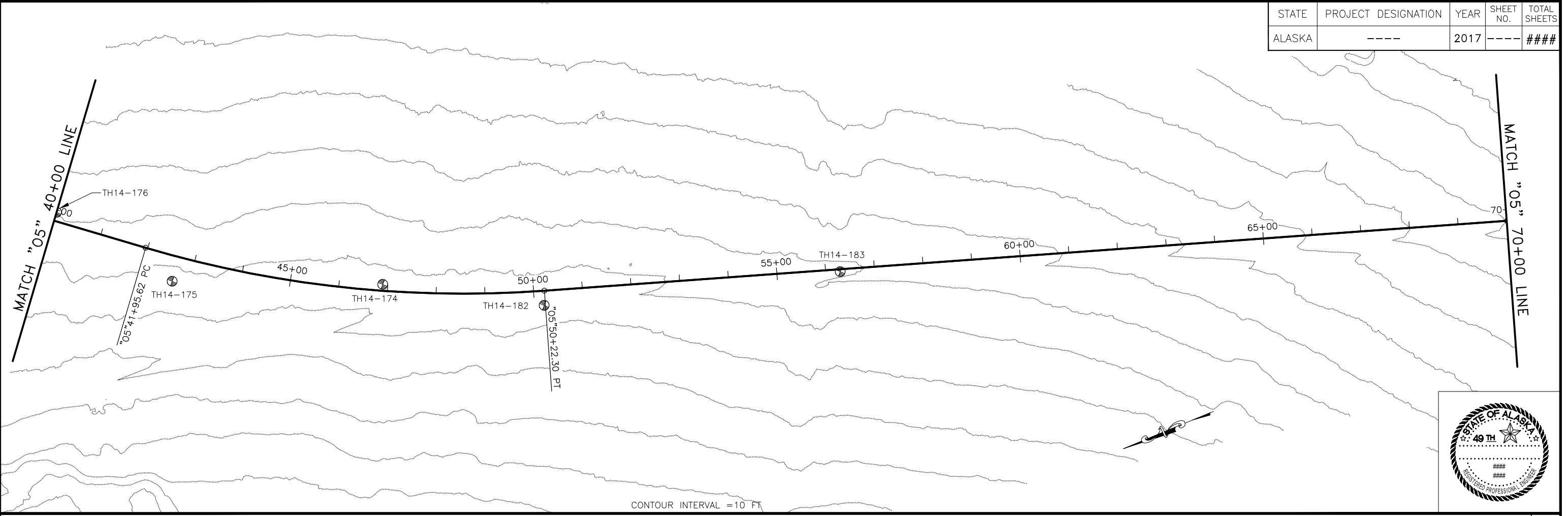

CONTOUR INTERVAL = 10 FT

H:\Projects\Dalton_Hwy\60911_Dalton_0_9_Recom\08 - Support\02 - Materials\Logs\60911_P&P-F2_05_40+00.00-70+00.00_Tue, Feb/24/15 01:50pm

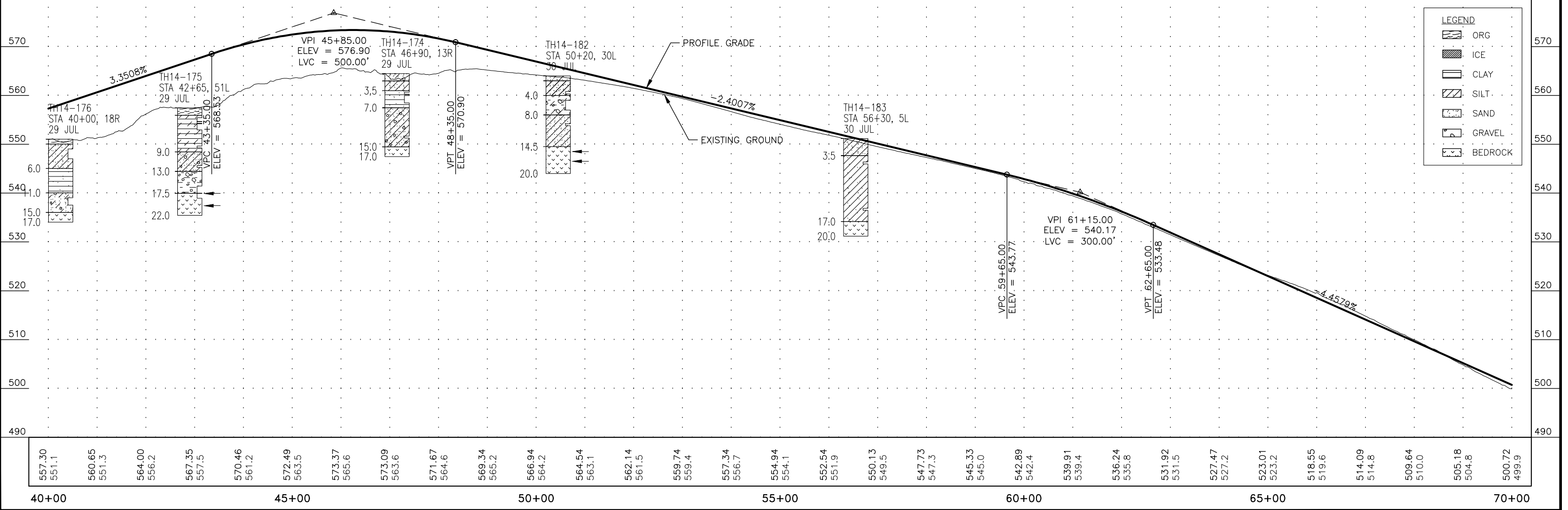

STATE	PROJECT DESIGNATION	YEAR	SHEET NO.	TOTAL SHEETS
ALASKA	----	2017	----	####

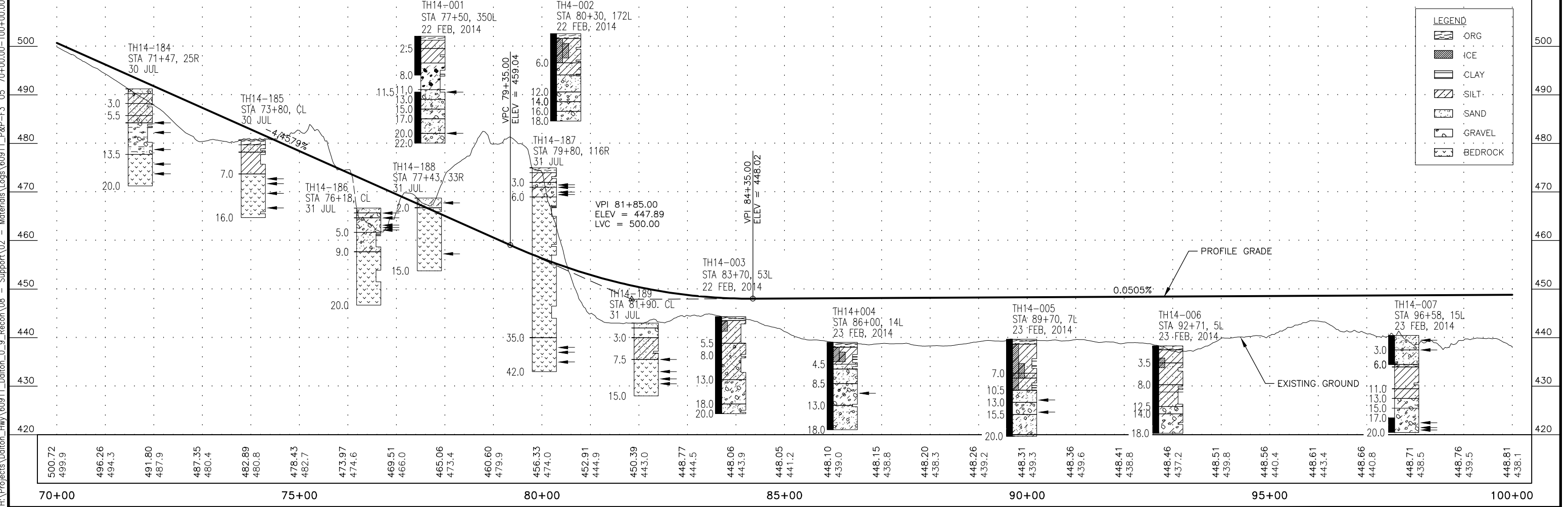
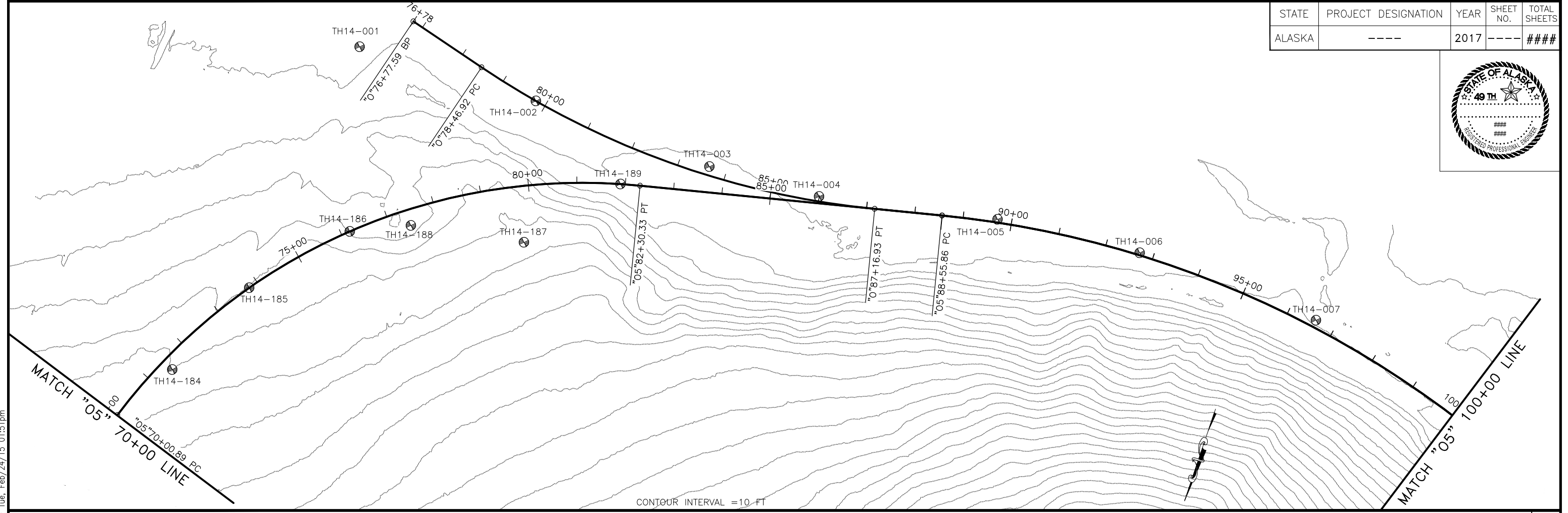
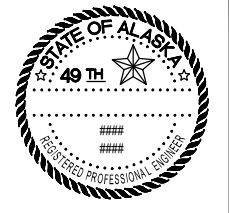

H:\Projects\Dalton_Hwy\60911_Dalton_0_9_Recon\08 - Support\02 - Materials\Logs\60911_P&P-F3 '05' 70+00.00-100+00.00 Tue, Feb/24/15 01:51pm

STATE	PROJECT DESIGNATION	YEAR	SHEET NO.	TOTAL SHEETS
ALASKA	----	2017	----	####

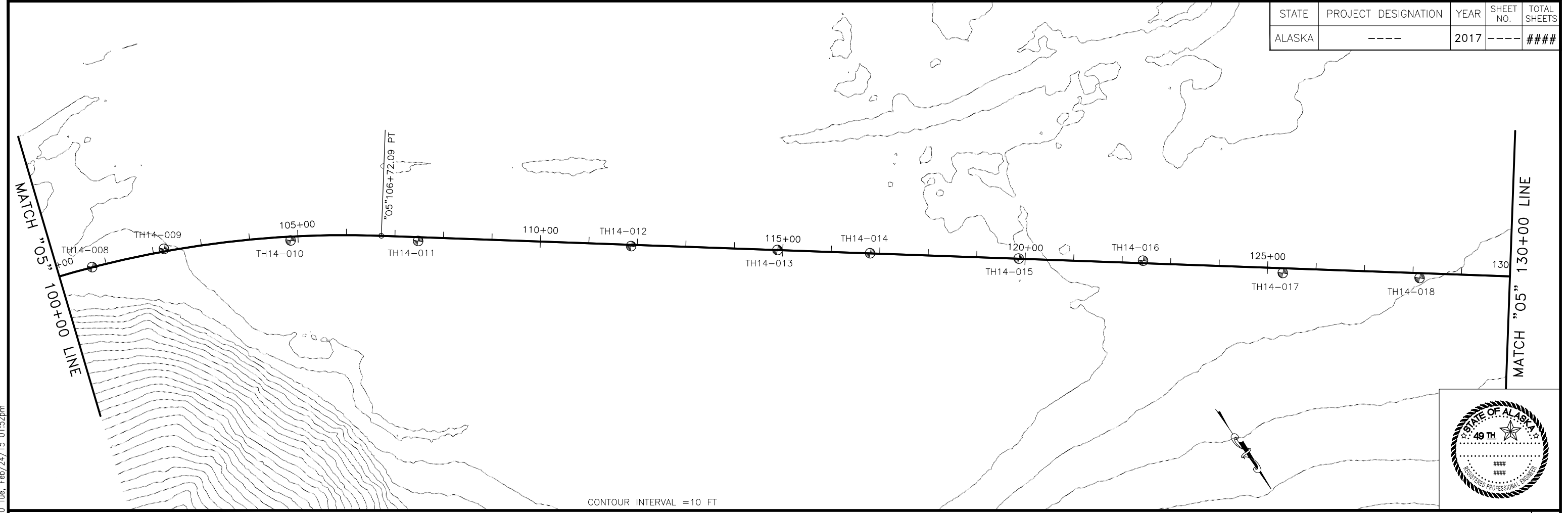

H:\Projects\Dotlon_Hwy\60911_Dotlon_0_9_Recom\08 - Support\02 - Materials\Logs\60911_P&P-F4_05_100+00.00-130+00.00_Tue_Feb/24/15_01:52pm

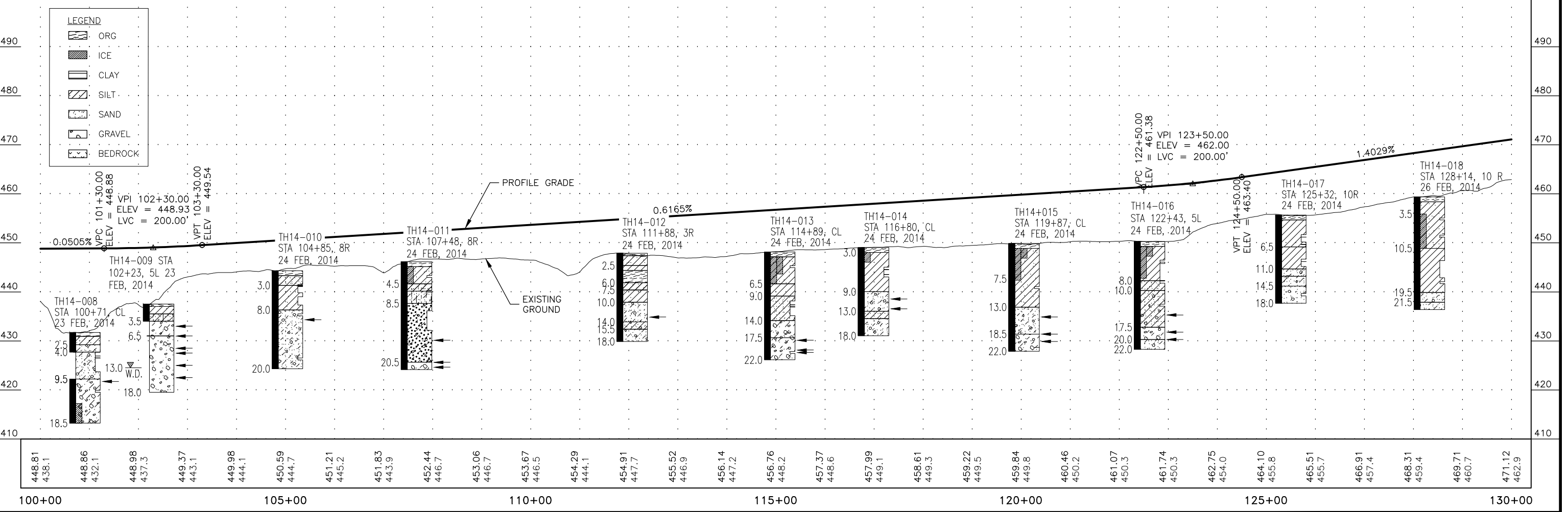

STATE	PROJECT DESIGNATION	YEAR	SHEET NO.	TOTAL SHEETS
ALASKA	----	2017	----	####

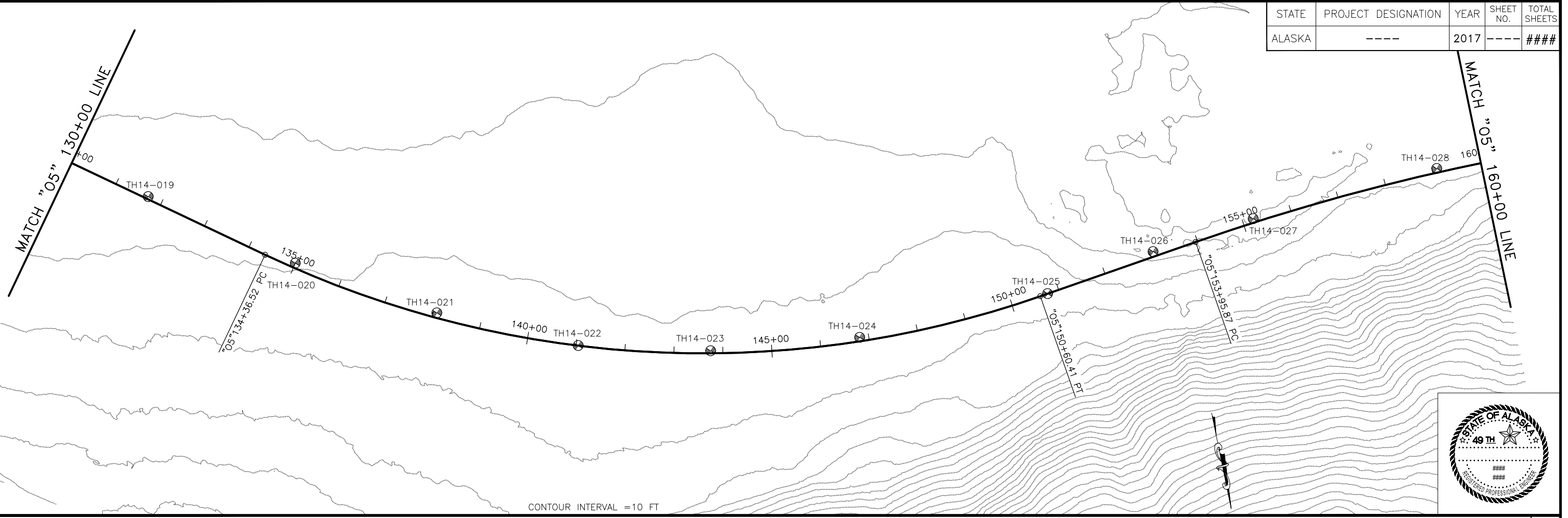

CONTOUR INTERVAL = 10 FT

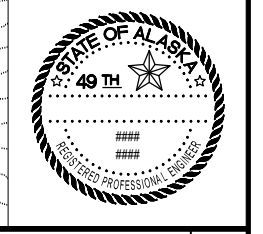

H:\Projects\Dotlon_Hwy\60911_Dotlon_0_9_Recom\08 - Support\02 - Materials\Logs\60911_P&P-F5 '05' 130+00.00-160+00.00_Tue, Feb/24/15 01:53pm

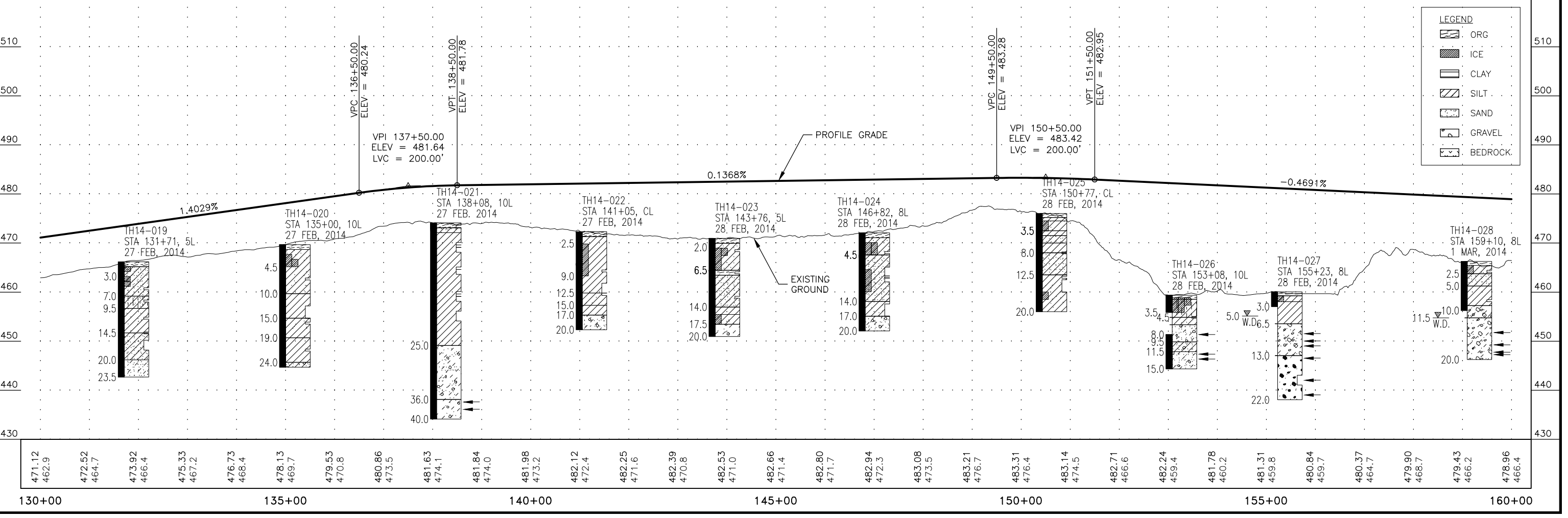

LEGEND

- ORG
- ICE
- CLAY
- SILT
- SAND
- GRAVEL
- BEDROCK

STATE	PROJECT DESIGNATION	YEAR	SHEET NO.	TOTAL SHEETS
ALASKA	----	2017	----	####

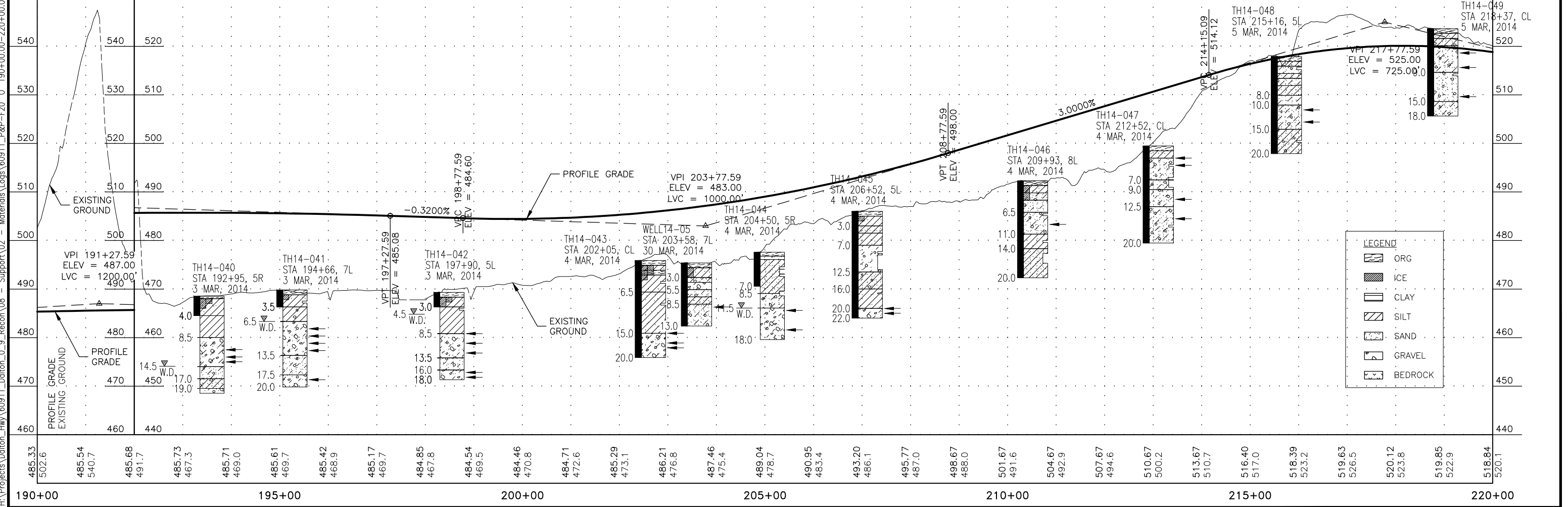
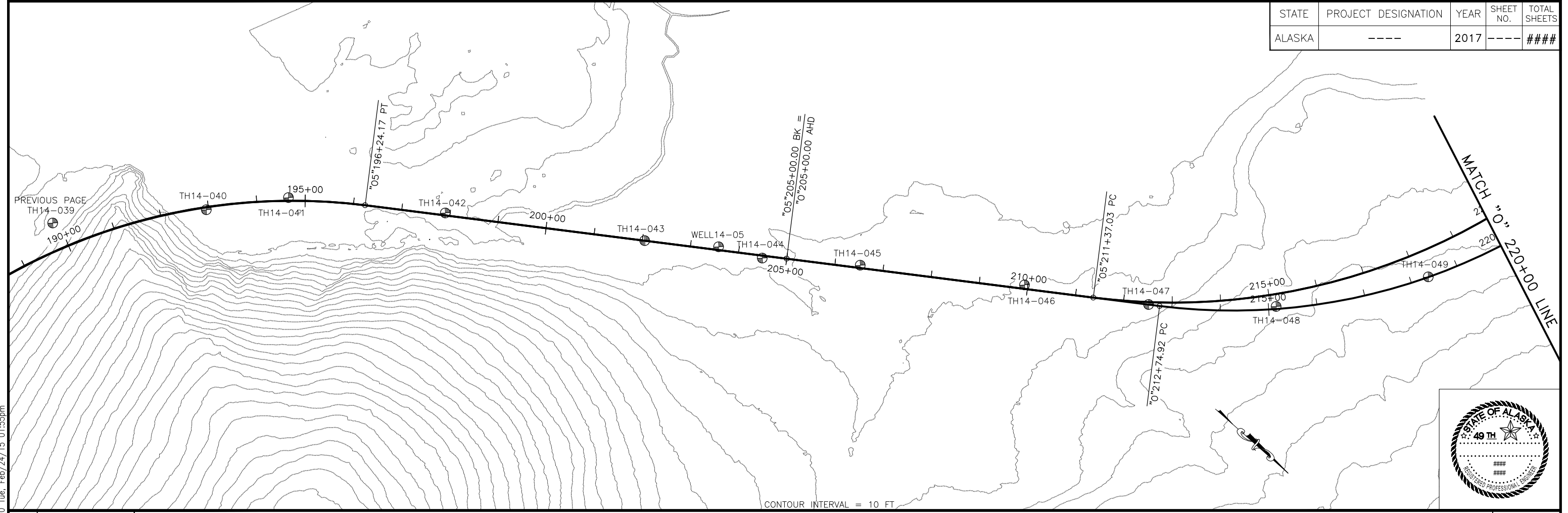

LEGEND

[Pattern]	ORG
[Pattern]	ICE
[Pattern]	CLAY
[Pattern]	SILT
[Pattern]	SAND
[Pattern]	GRAVEL
[Pattern]	BEDROCK

H:\Projects\Dotlon_Hwy\60911_Dotlon_0_9_Recon\08 - Support\02 - Materials\Logs\60911_P&P-F20 '0' 190+00.00-220+00.00_Tue, Feb/24/15 01:55pm

STATE	PROJECT DESIGNATION	YEAR	SHEET NO.	TOTAL SHEETS
ALASKA	----	2017	----	####

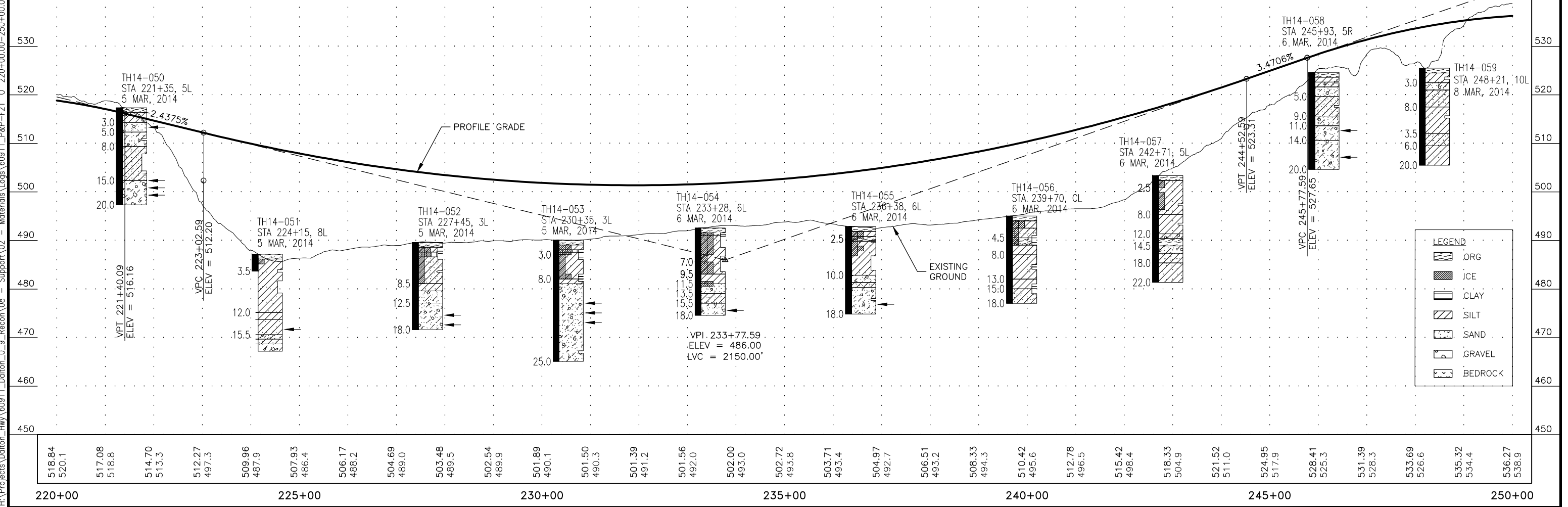
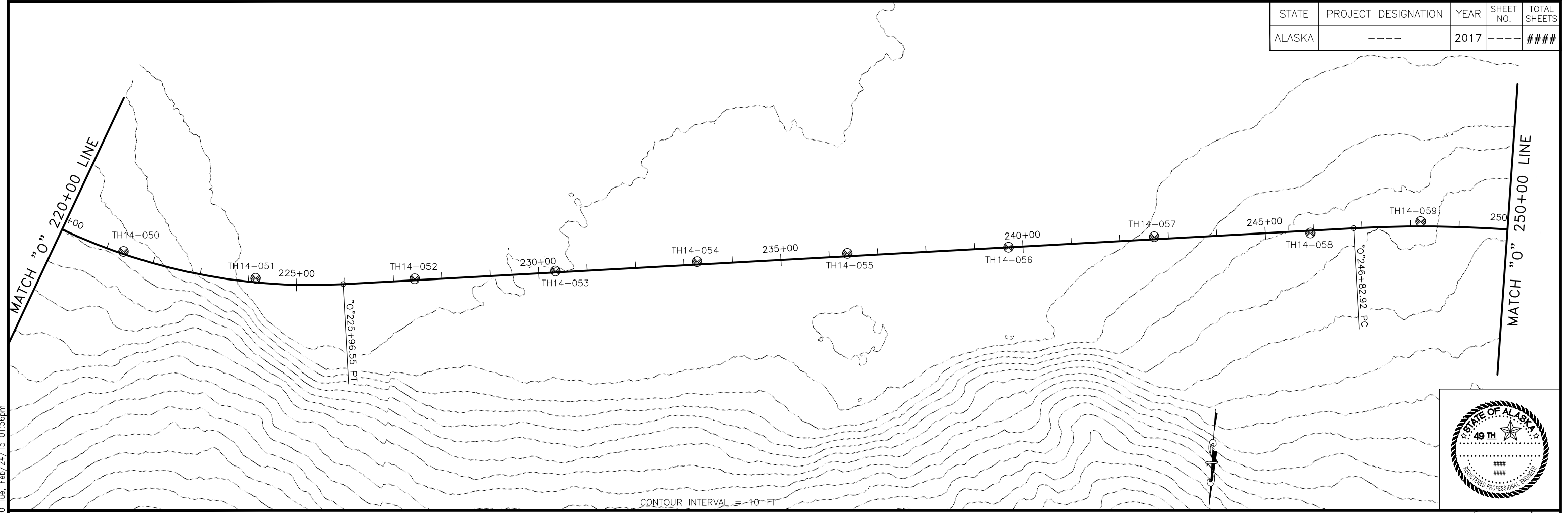

H:\Projects\Dotlon_Hwy\60911_Dotlon_0_9_Recom\08 - Support\02 - Materials\Logs\60911_P&P-F21_0 - 220+00.00-250+00.00_Tue, Feb/24/15 01:56pm

STATE	PROJECT DESIGNATION	YEAR	SHEET NO.	TOTAL SHEETS
ALASKA	----	2017	----	####

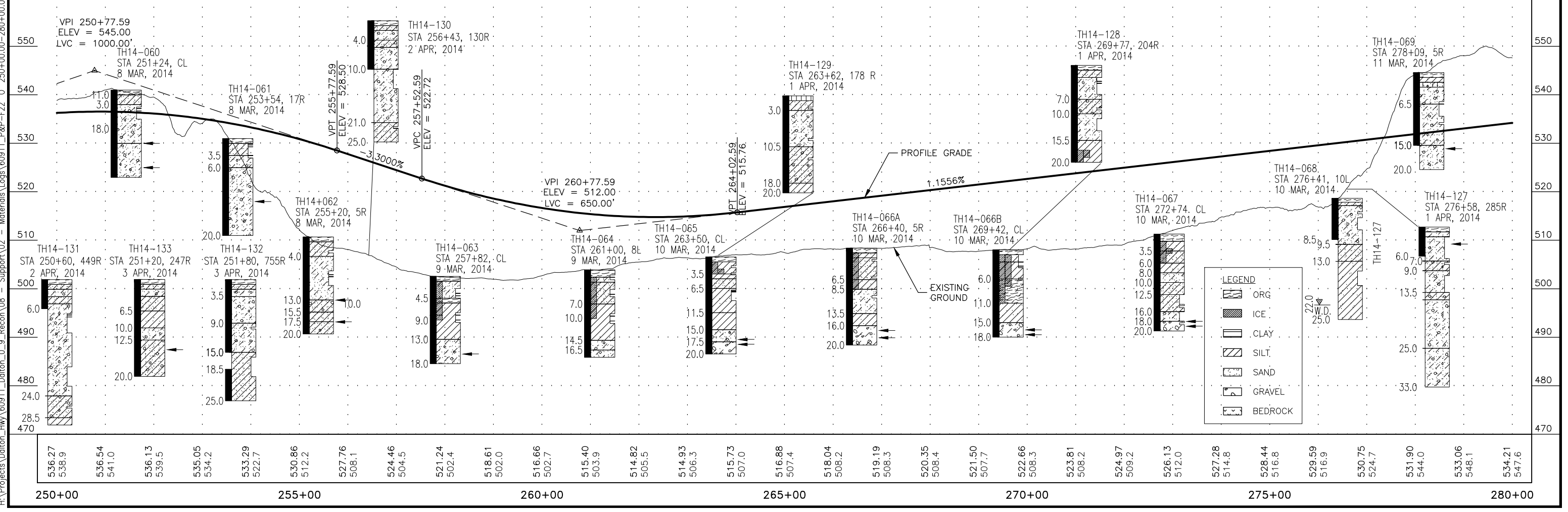
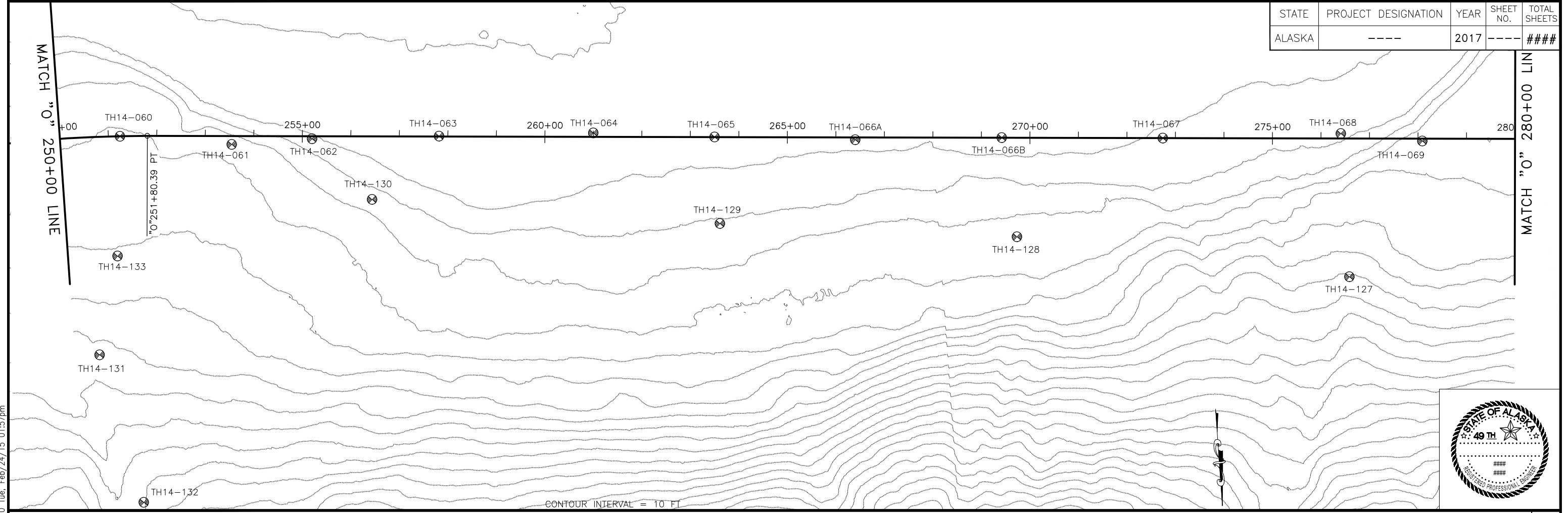

H:\Projects\Dotlon_Hwy\60911_Hwy\60911_P&P-F22_0_250+00.00-280+00.00_Tue_Feb/24/15 01:57pm

STATE	PROJECT DESIGNATION	YEAR	SHEET NO.	TOTAL SHEETS
ALASKA	----	2017	----	####

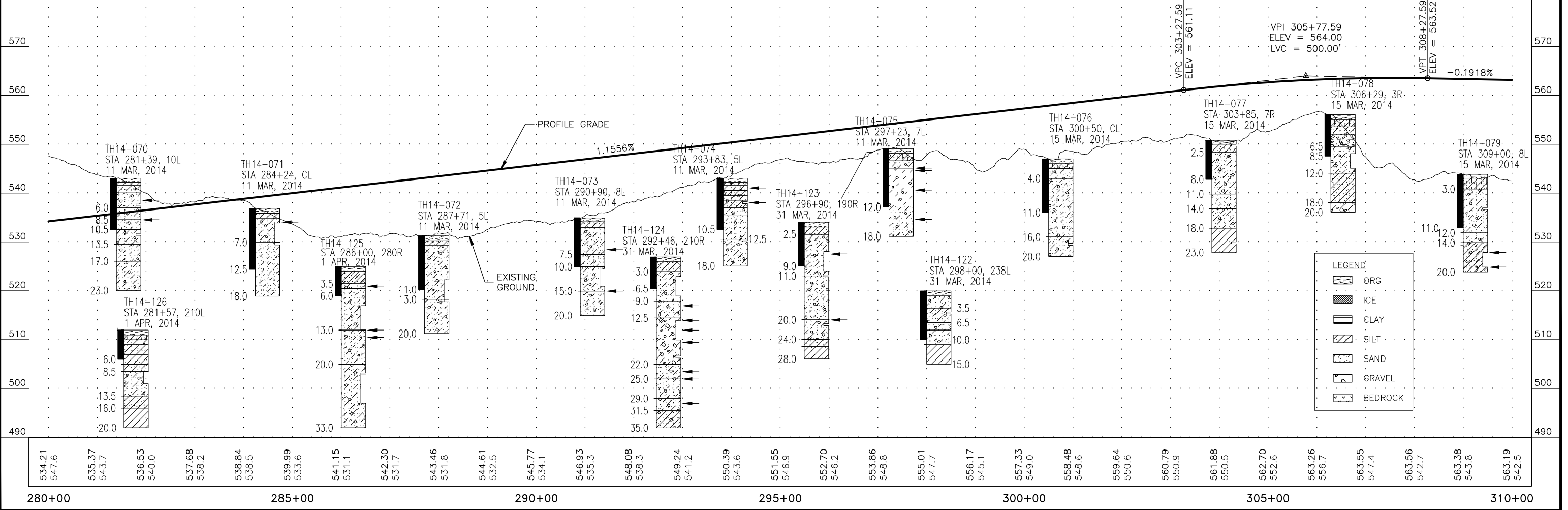
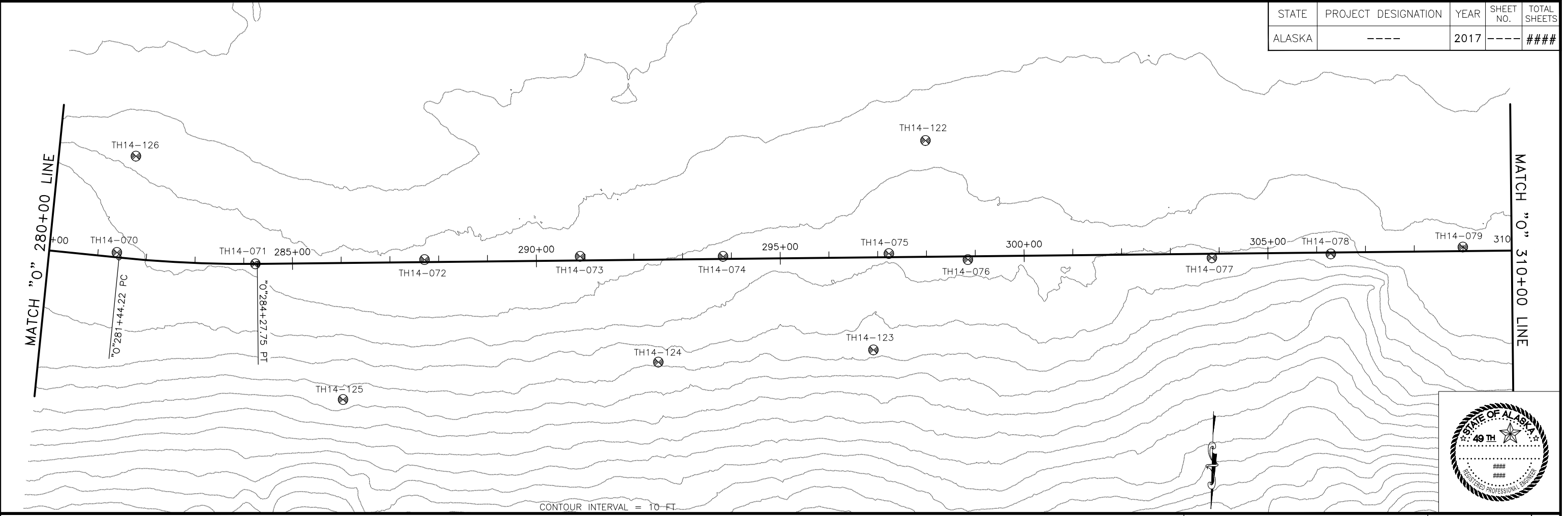

H:\Projects\Dotlon_Hwy\60911_Dotlon_0_9_Recon\08 - Support\02 - Materials\Logs\60911_P&P-F23_0_280+00.00-310+00.00_Tue, Feb/24/15 01:58pm

STATE	PROJECT DESIGNATION	YEAR	SHEET NO.	TOTAL SHEETS
ALASKA	----	2017	----	####

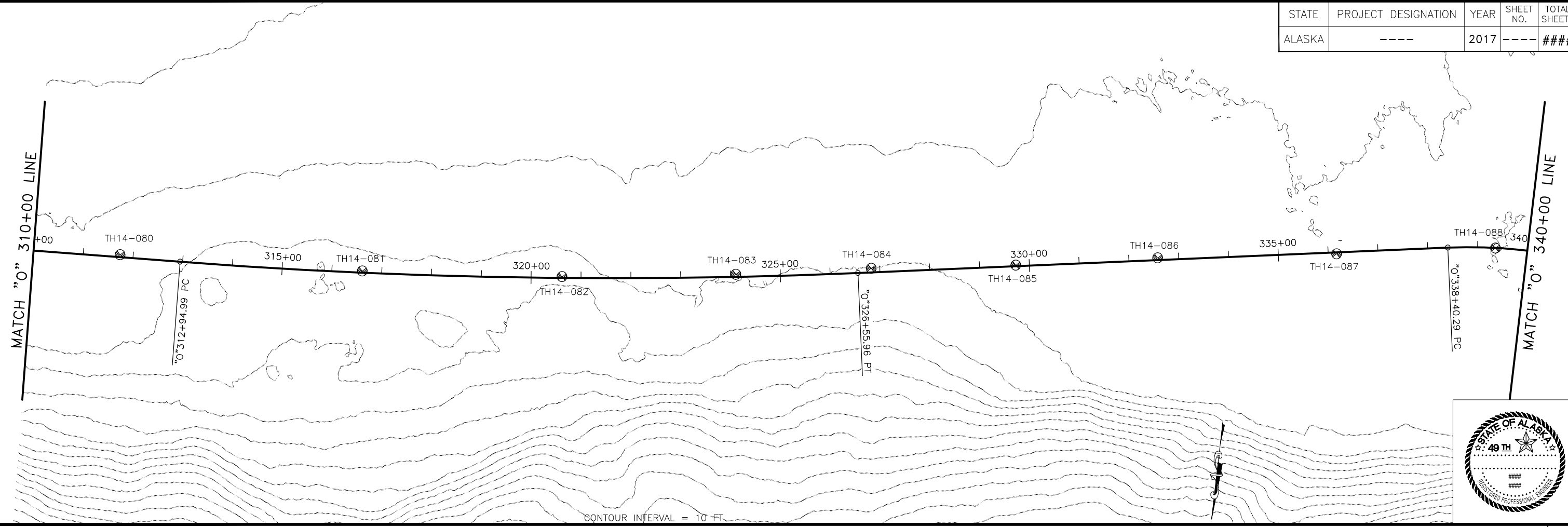

CONTOUR INTERVAL = 10' FT.

H:\Projects\Dotlon_Hwy\60911_Hwy\60911_P&P-F24_0_310+00.00-340+00.00_Tue, Feb/24/15 01:59pm

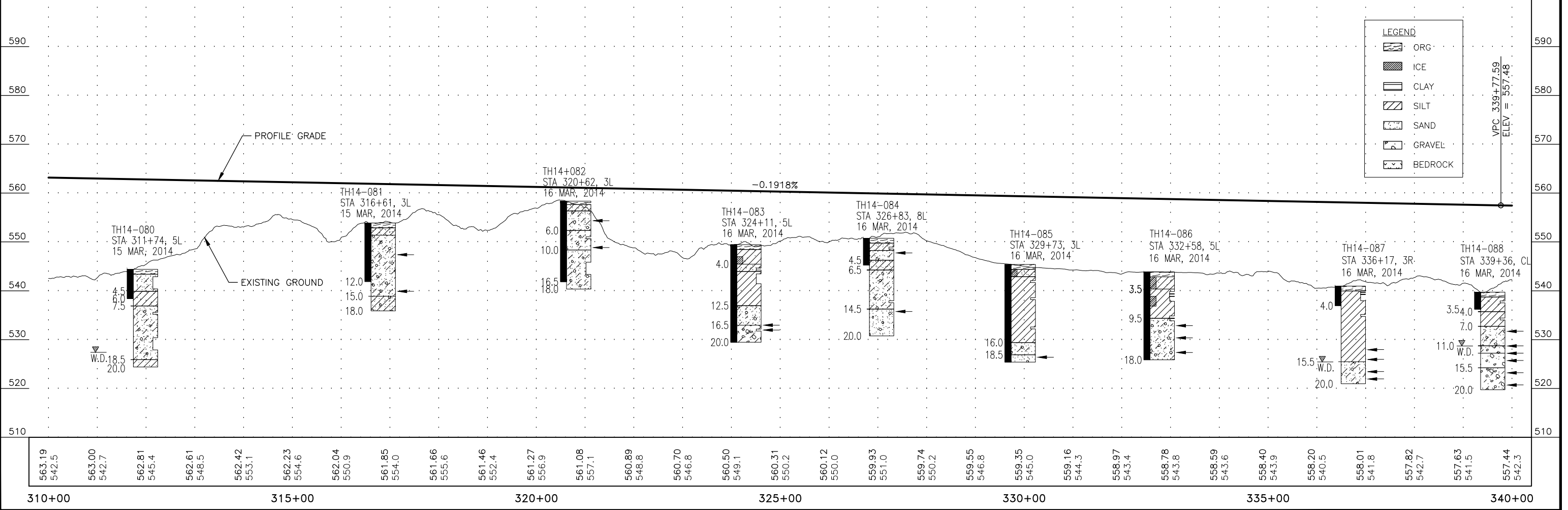

LEGEND

- ORG
- ICE
- CLAY
- SILT
- SAND
- GRAVEL
- BEDROCK

VPC 339+77.59
ELEV = 557.48

STATE	PROJECT DESIGNATION	YEAR	SHEET NO.	TOTAL SHEETS
ALASKA	----	2017	----	####

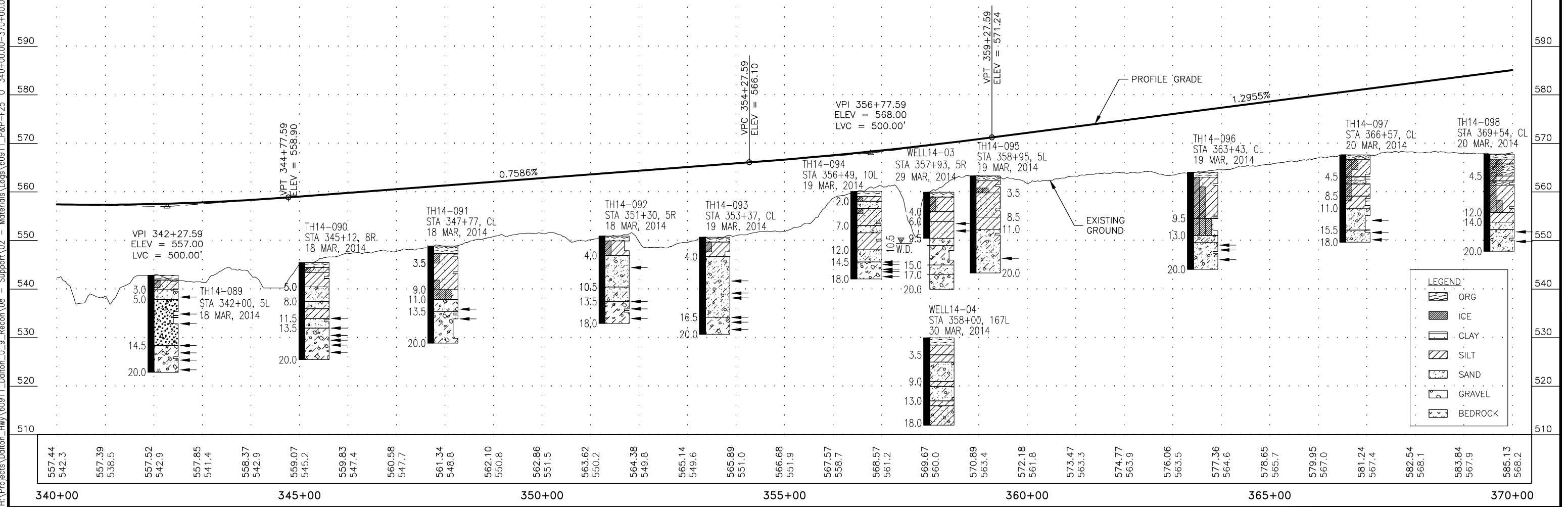
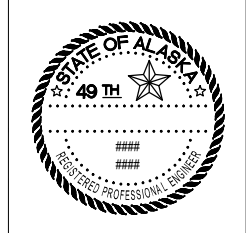
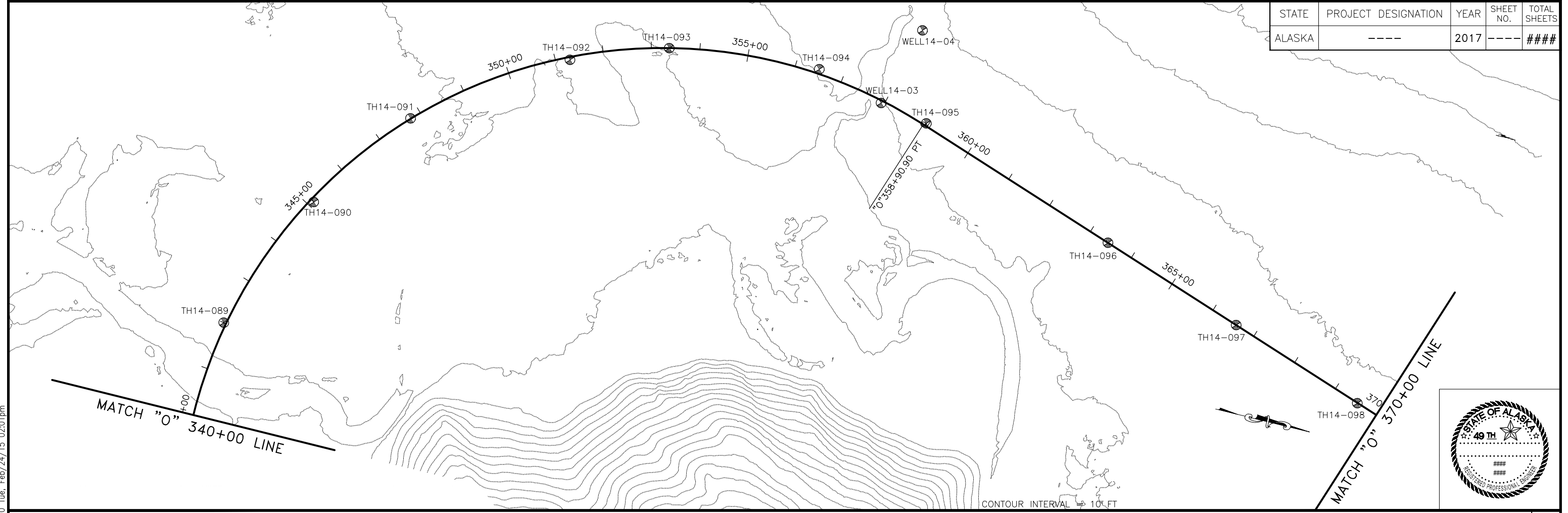

H:\Projects\Dotlon_Hwy\60911_Dotlon_0_9_Recon\08 - Support\02 - Materials\Logs\60911_P&P-F25 '0' 340+00.00-370+00.00_Tue, Feb/24/15 02:01pm

STATE	PROJECT DESIGNATION	YEAR	SHEET NO.	TOTAL SHEETS
ALASKA	----	2017	----	####

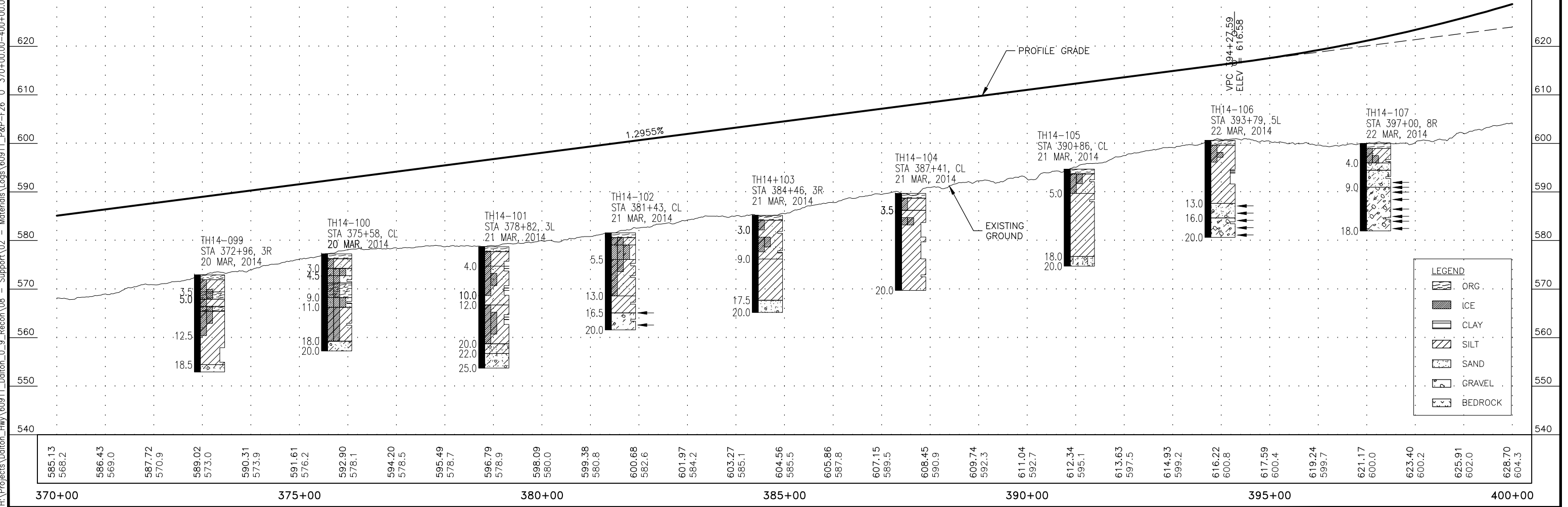
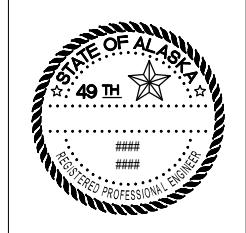
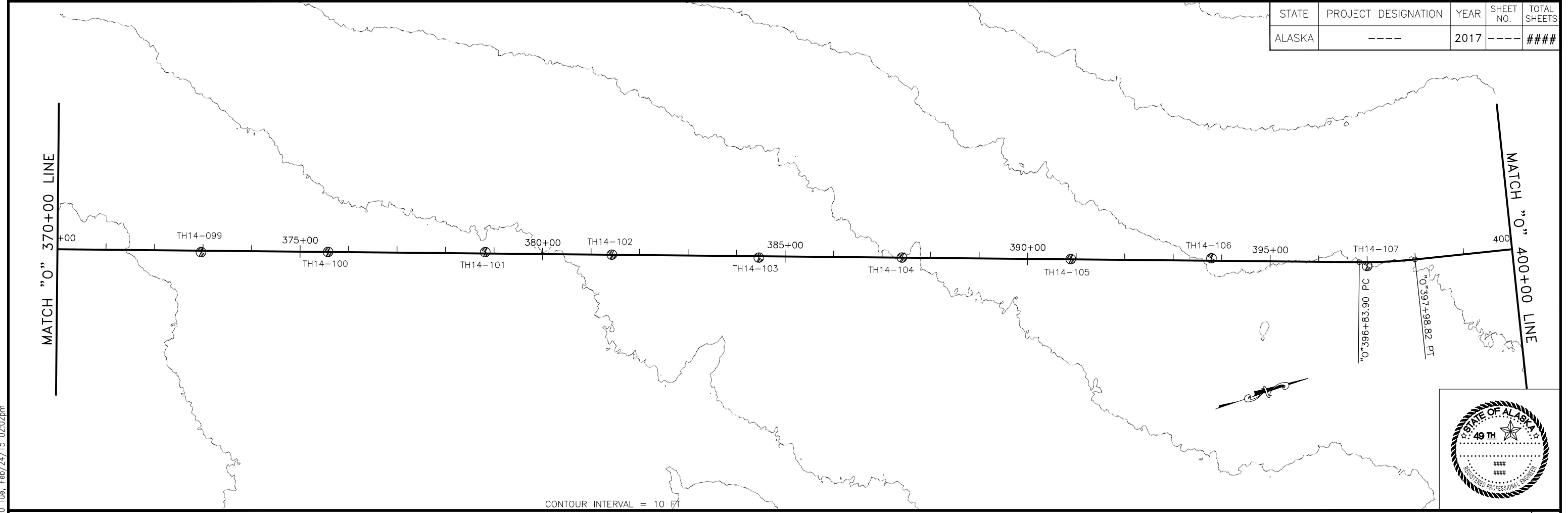

H:\Projects\Dotlon_Hwy\60911_Dotlon_0_9_Recom\08 - Support\02 - Materials\Logs\60911_P&P-F26 'O' 370+00.00-400+00.00_Tue, Feb/24/15 02:02pm

STATE	PROJECT DESIGNATION	YEAR	SHEET NO.	TOTAL SHEETS
ALASKA	----	2017	----	####

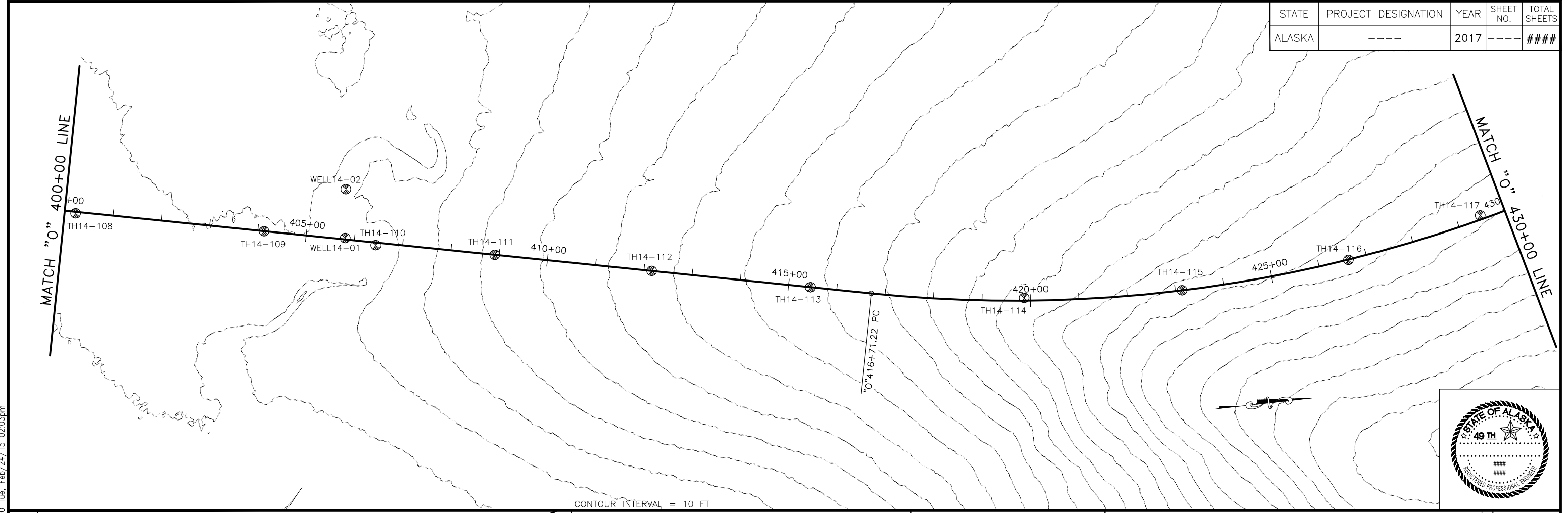

CONTOUR INTERVAL = 10 FT

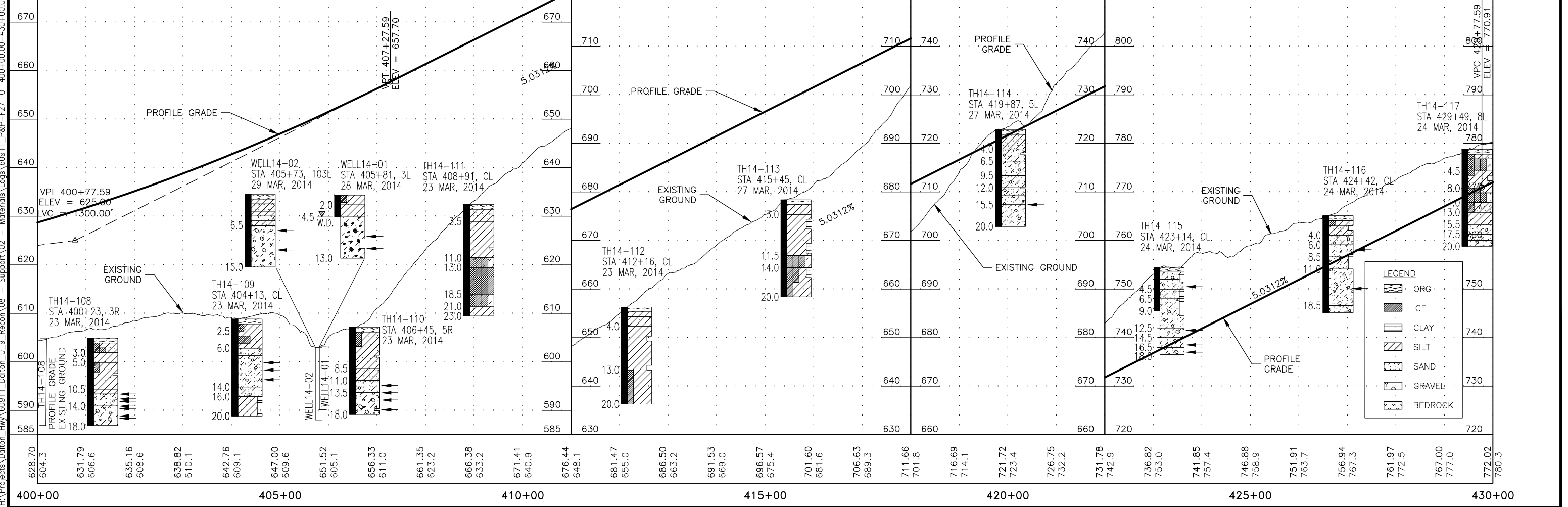

LEGEND

	ORG
	ICE
	CLAY
	SILT
	SAND
	GRAVEL
	BEDROCK

H:\Projects\Dalton_Hwy\60911_Dalton_0_9_Recon\08 - Support\02 - Materials\Logs\60911_P&P-F27 '0 - 400+00.00-430+00.00_Tue, Feb/24/15 02:03pm

STATE	PROJECT DESIGNATION	YEAR	SHEET NO.	TOTAL SHEETS
ALASKA	----	2017	----	####

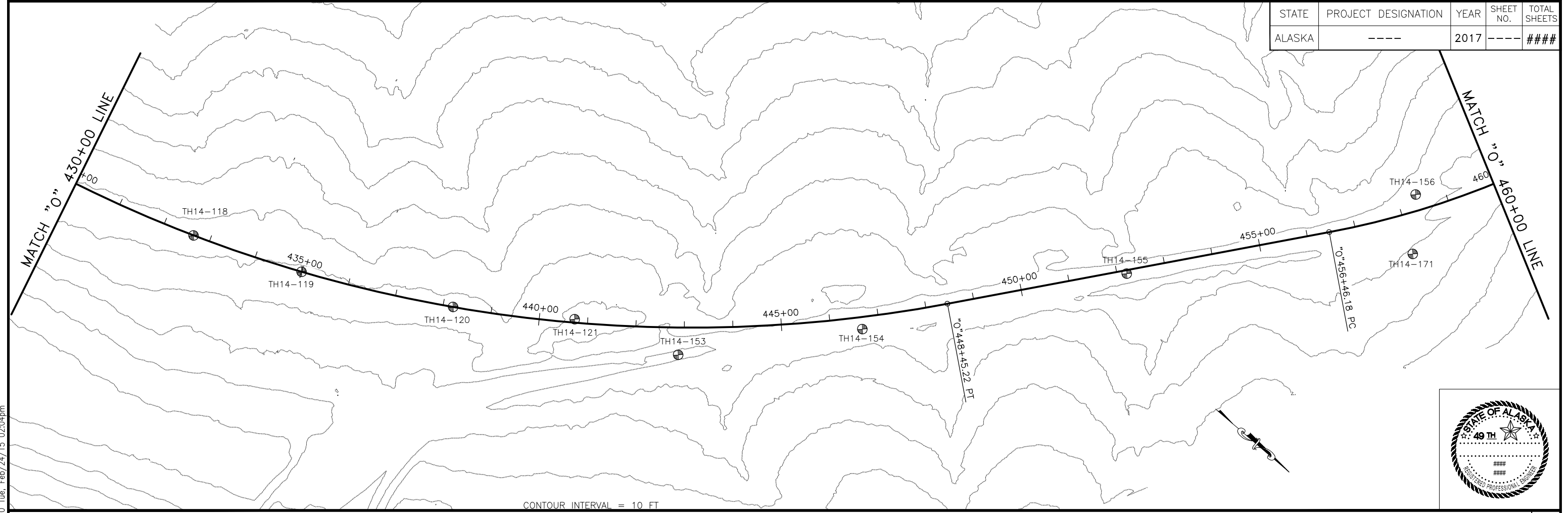

CONTOUR INTERVAL = 10 FT



H:\Projects\Dotlon_Hwy\60911_Dotlon_0_9_Recon\08 - Support\02 - Materials\Logs\60911_P&P-F28 'O' 430+00.00-460+00.00_Tue, Feb/24/15 02:04pm

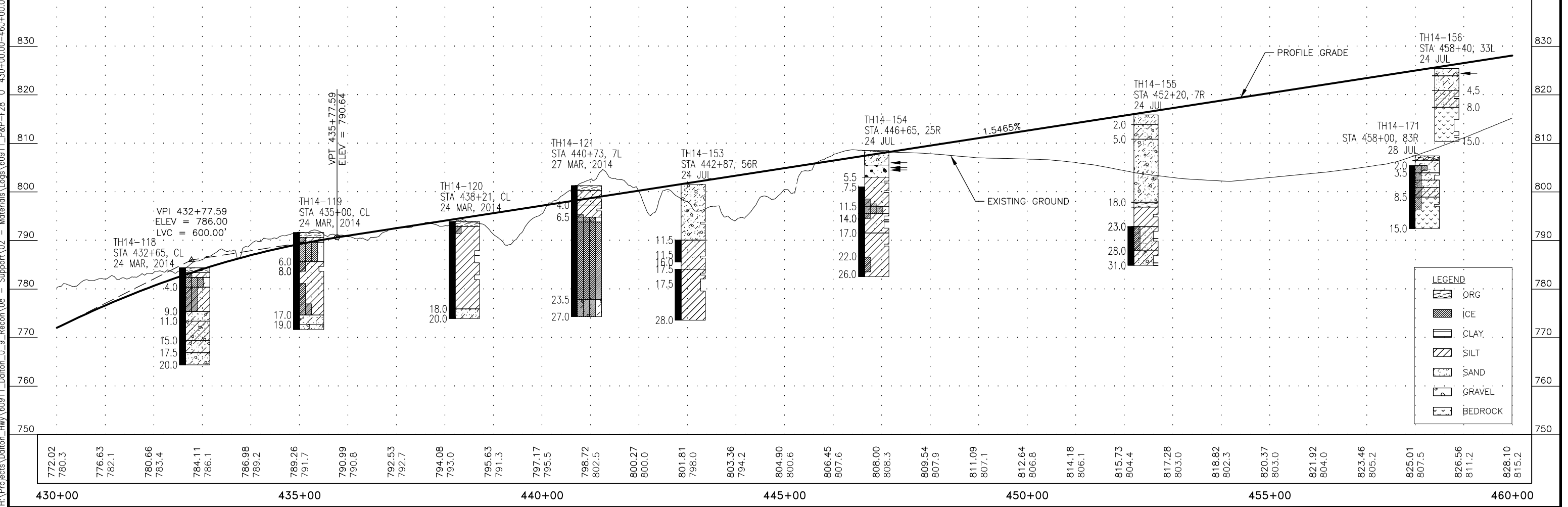

LEGEND

- ORG
- ICE
- CLAY
- SILT
- SAND
- GRAVEL
- BEDROCK

STATE	PROJECT DESIGNATION	YEAR	SHEET NO.	TOTAL SHEETS
ALASKA	---	2017	---	####

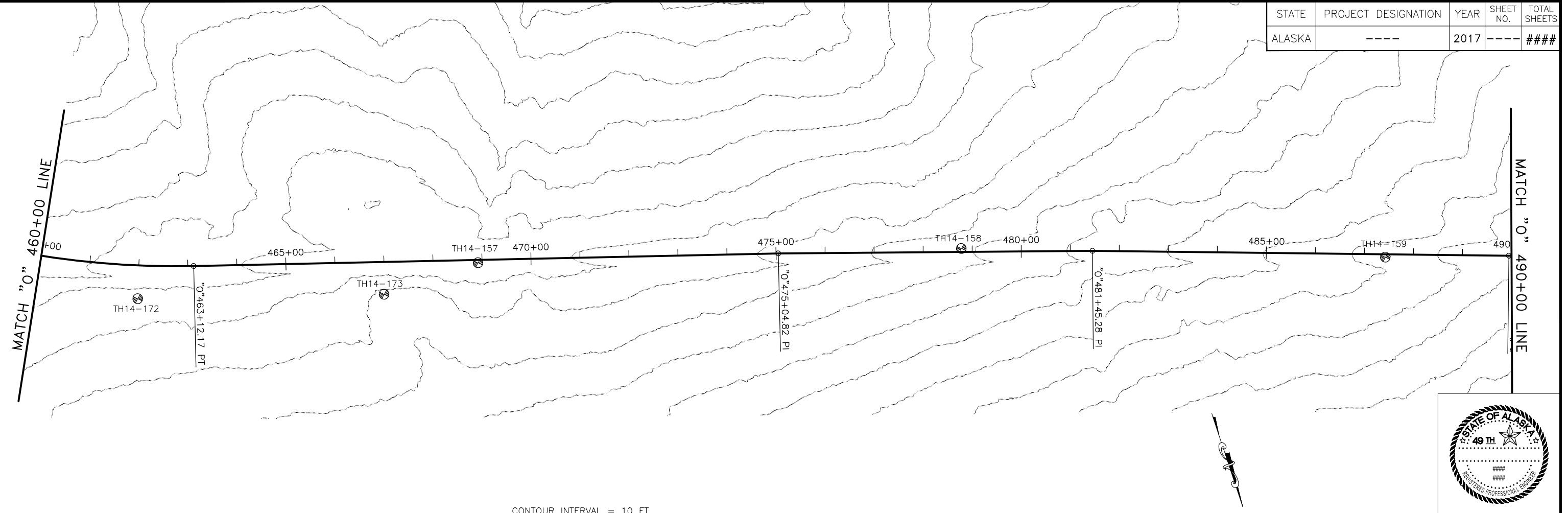

CONTOUR INTERVAL = 10 FT



H:\Projects\Dalton_Hwy\60911_Dalton_0_9_Recom\08 - Support\02 - Materials\Logs\60911_P&P-F29_0 - 460+00.00-490+00.00_Tue, Feb/24/15 02:05pm

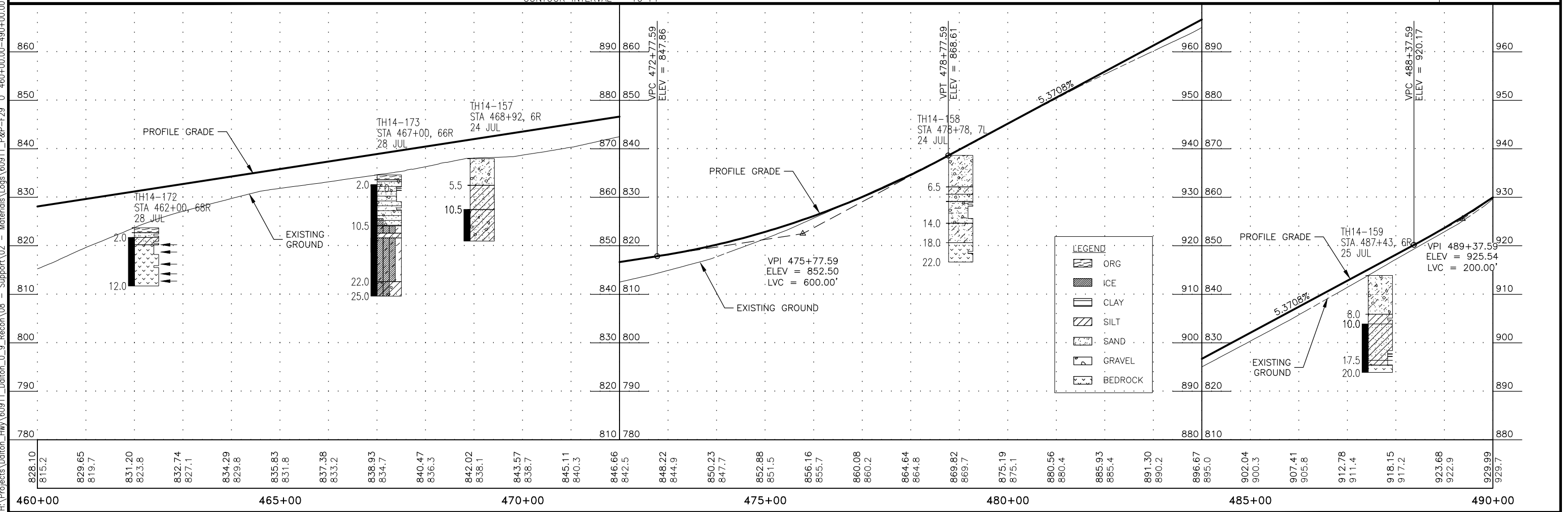

LEGEND

- ORG
- ICE
- CLAY
- SILT
- SAND
- GRAVEL
- BEDROCK

460+00 465+00 470+00 475+00 480+00 485+00 490+00

STATE	PROJECT DESIGNATION	YEAR	SHEET NO.	TOTAL SHEETS
ALASKA	----	2017	----	####

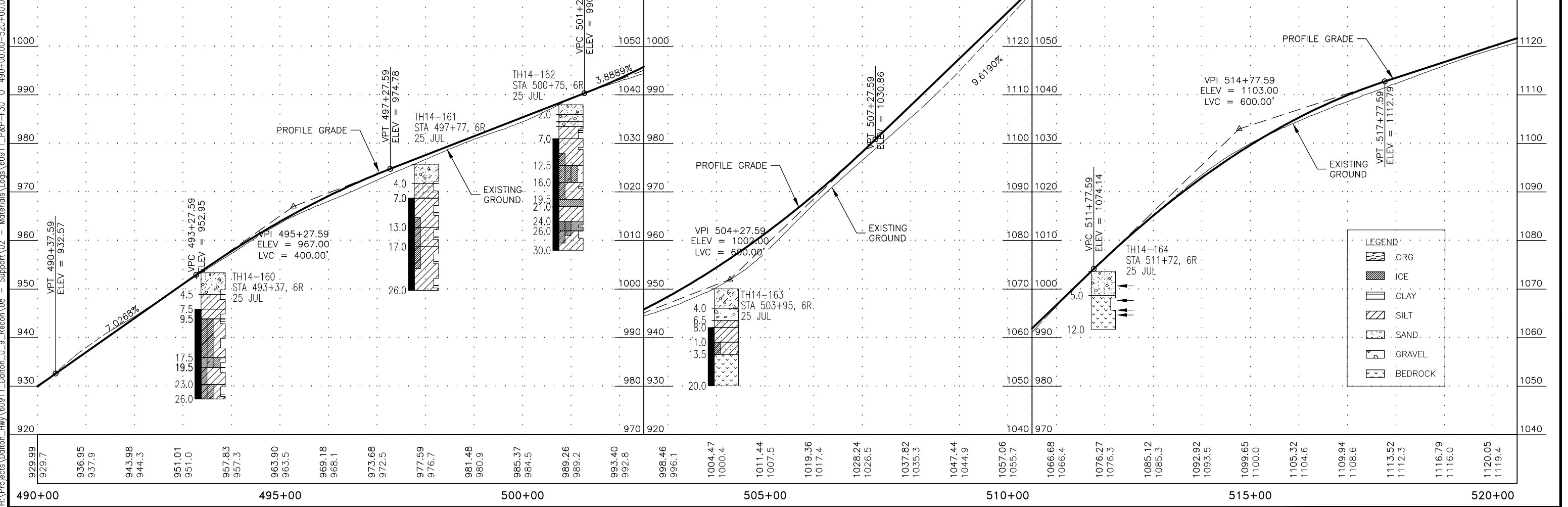
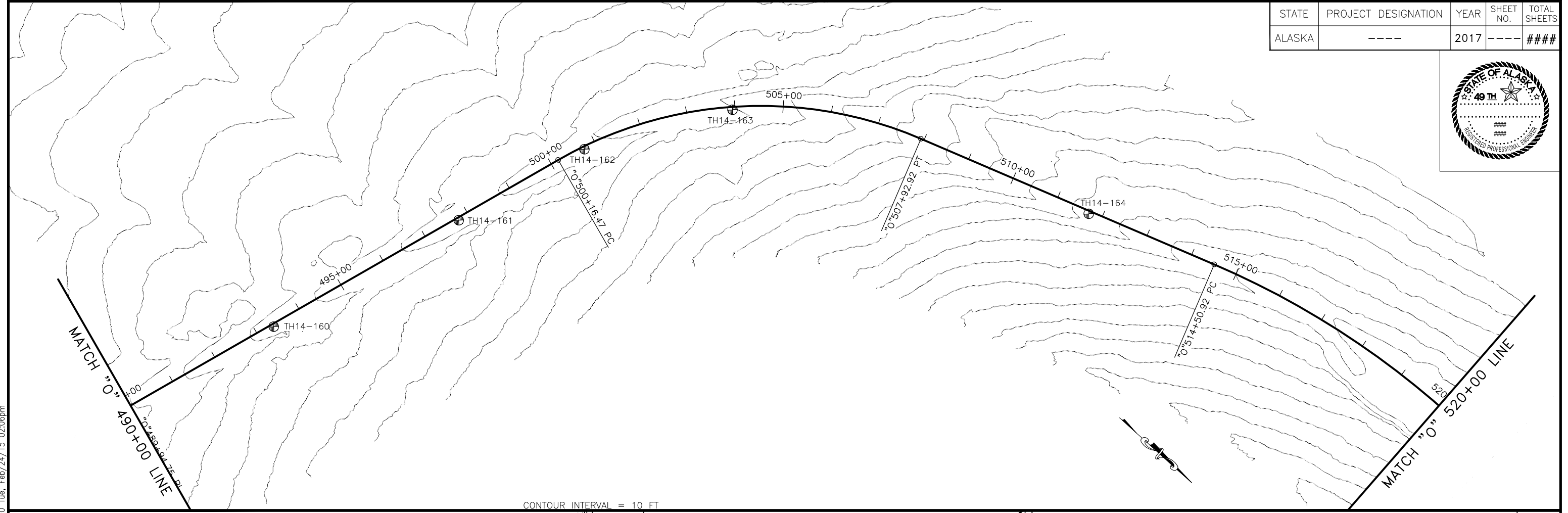

H:\Projects\Dalton_Hwy\60911_Dalton_0_9_Recon\08 - Support\02 - Materials\Logs\60911_P&P-F30 '0' 490+00.00-520+00.00_Tue, Feb/24/15 02:06pm

STATE	PROJECT DESIGNATION	YEAR	SHEET NO.	TOTAL SHEETS
ALASKA	----	2017	----	####

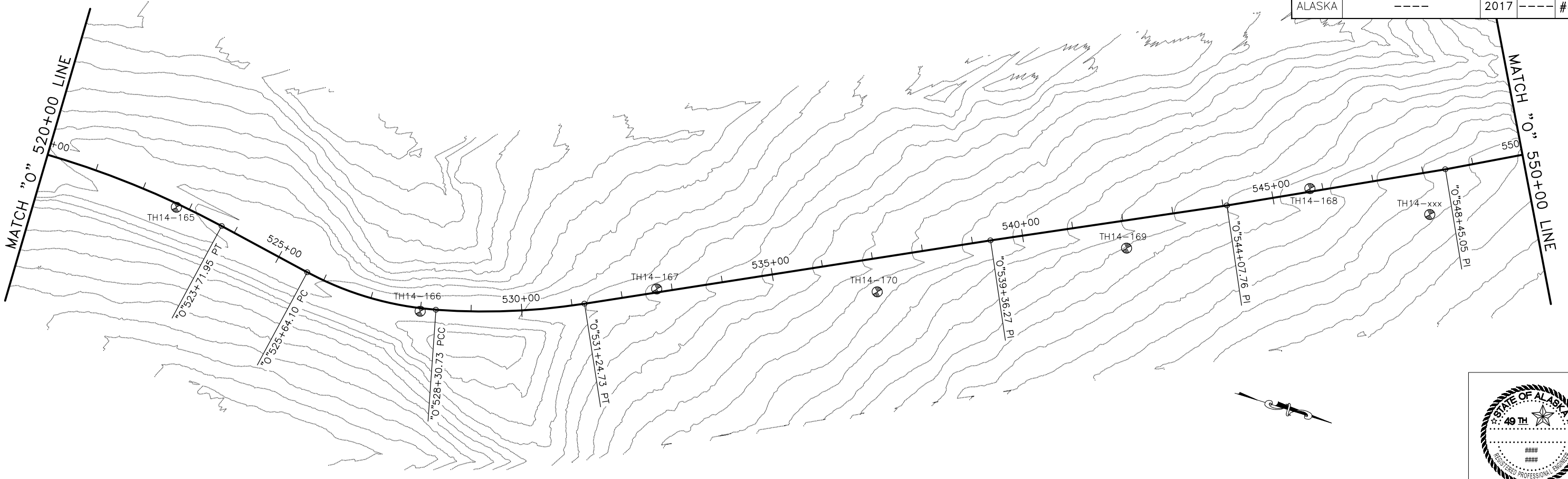

CONTOUR INTERVAL = 10 FT



LEGEND

[Symbol]	ORG
[Symbol]	ICE
[Symbol]	CLAY
[Symbol]	SILT
[Symbol]	SAND
[Symbol]	GRAVEL
[Symbol]	BEDROCK

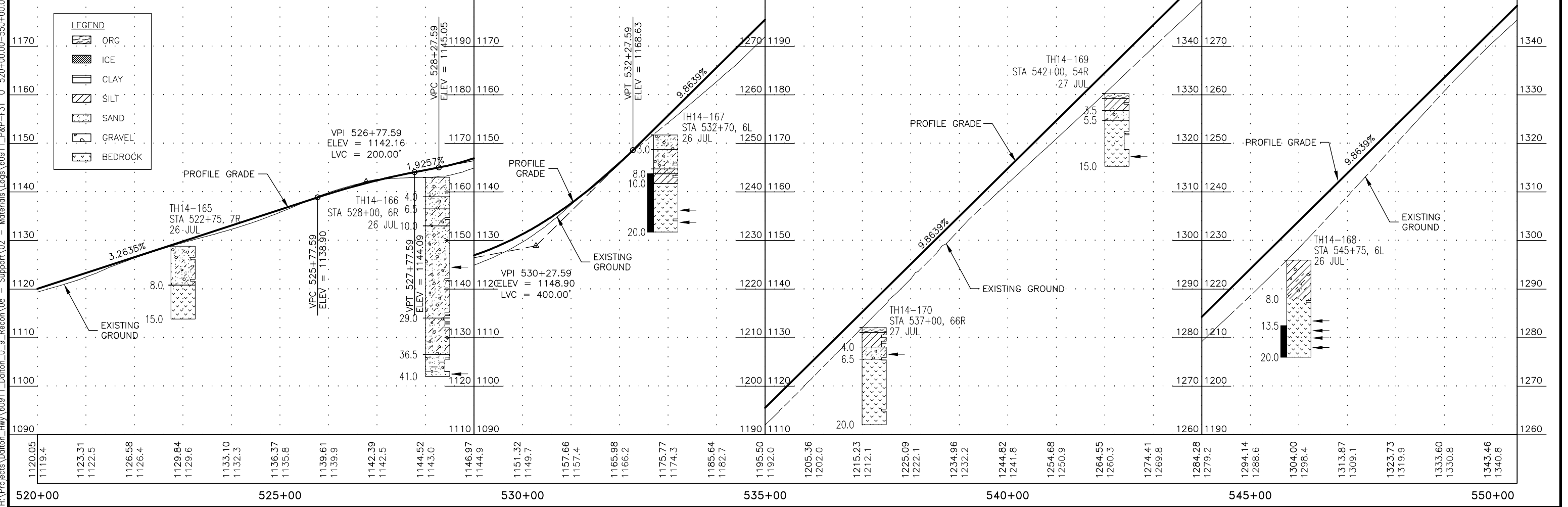

H:\Projects\Dalton_Hwy\60911_Dalton_0_9_Recon\08 - Support\02 - Materials\Logs\60911_P&P-F31_0_520+00.00-550+00.00_Tue, Feb/24/15 02:08pm

STATE	PROJECT DESIGNATION	YEAR	SHEET NO.	TOTAL SHEETS
ALASKA	----	2017	----	####

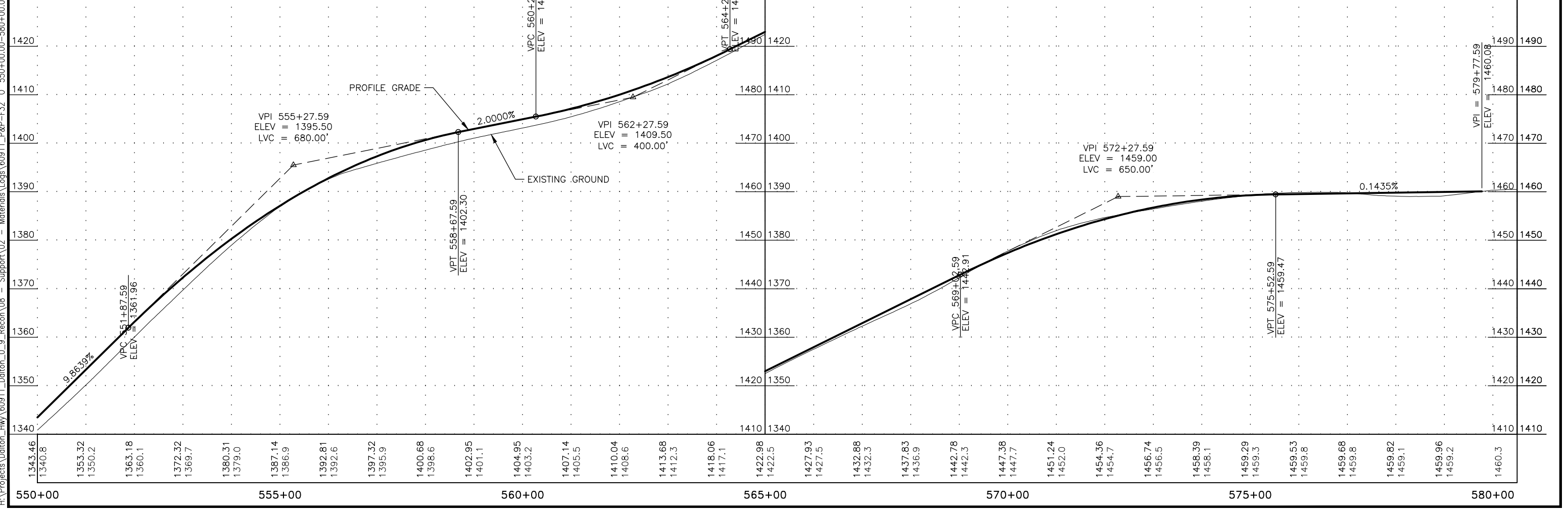
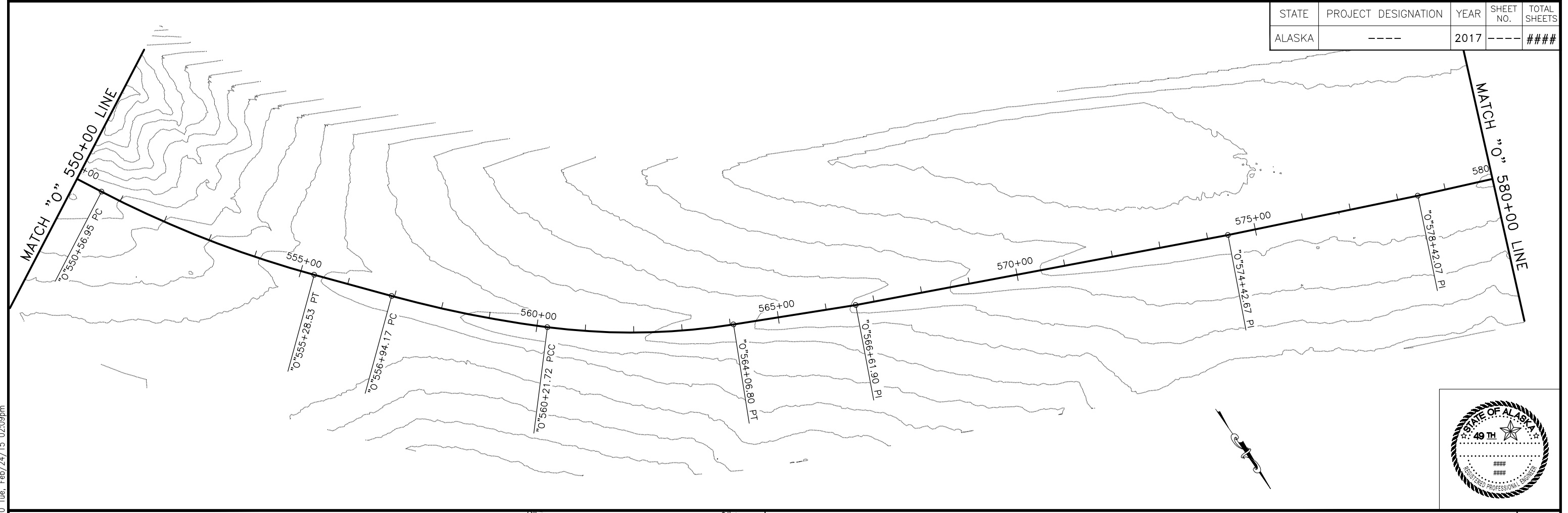

H:\Projects\Dalton_Hwy\60911_Dalton_0_9_Recom\08 - Support\02 - Materials\Logs\60911_P&P-F32 '0' 550+00.00-580+00.00 Tue, Feb/24/15 02:09pm

STATE	PROJECT DESIGNATION	YEAR	SHEET NO.	TOTAL SHEETS
ALASKA	----	2017	----	####

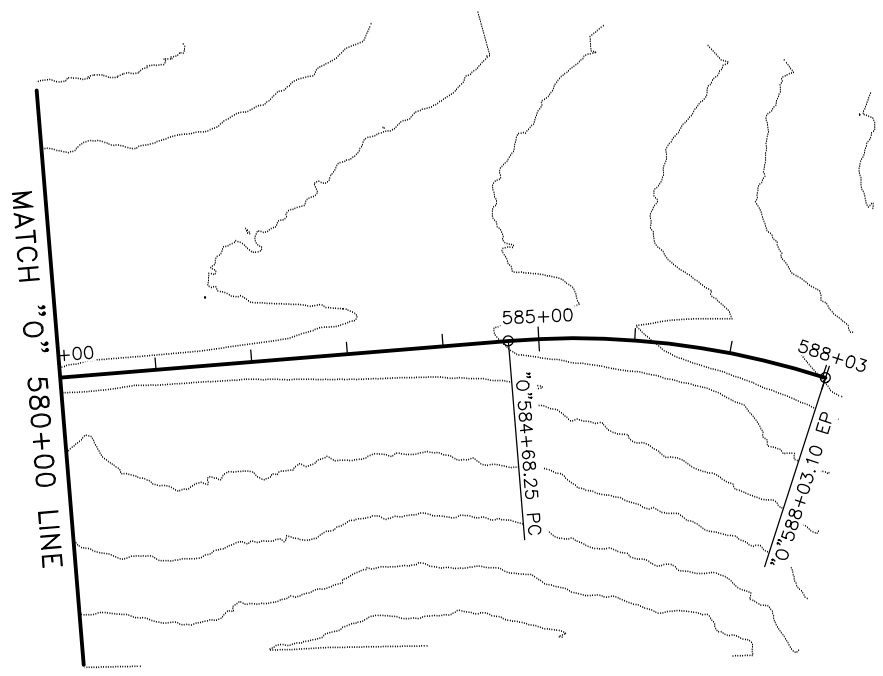

CONTOUR INTERVAL = 10 FT

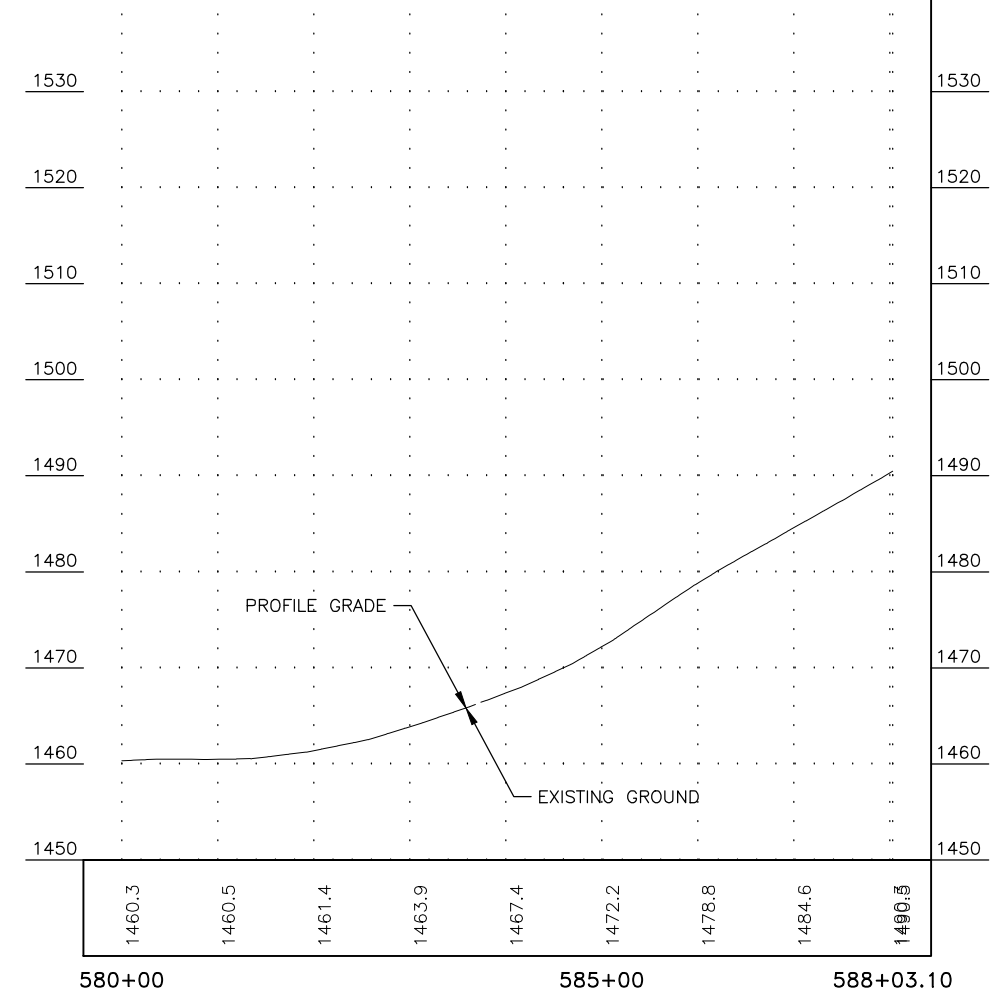
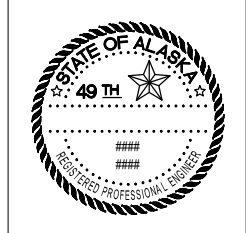

LEGEND

	ORG
	ICE
	CLAY
	SILT
	SAND
	GRAVEL
	BEDROCK

H:\Projects\Dalton_Hwy\60911_Dalton_0_9_Recon\08 - Support\02 - Materials\Logs\60911_P&P-F33 '0' 580+00.00-588+03.10 Tue, Feb/24/15 02:10pm

SYMBOLS AND DEFINITIONS

SYMBOLS AND DEFINITIONS

BASIC MATERIAL SYMBOLS

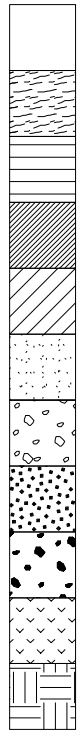

- ASPHALT
- PEAT
- CLAY (Cl)
- ICE
- SILT (Si)
- POORLY GRADED SAND (Sa)
- POORLY GRADED GRAVEL (Gr)
- WELL GRADED SAND
- WELL GRADED GRAVEL
- BEDROCK (Bx), soft(Type)
- BEDROCK (Bx), hard(Type)

SOFT OR HARD BEDROCK BASED ON DRILLING RATE

NOTE

MAIN COMPONENT (UPPER CASE ... SOLID LINES)
 MINOR COMPONENT (Title Case ... DASHED LINES
 OR SPARSER PATTERN)

USCS SIZE DEFINITIONS

- BOULDERS (Boulders) 12"+
- COBBLES (Cobbles) 3" TO 12"
- GRAVEL #4 TO 3"
- ANGULAR FRAGMENTS #10 +
- SAND #200 TO #4
- SILT #200 TO 0.005 mm
- CLAY MINUS 0.005 mm

TEST RESULTS

- ...% -200 = % PASSING #200 SIEVE
- NM ...% = NATURAL MOISTURE
- ORG ...% = ORGANIC CONTENT
- SSc _ = SODIUM SULFATE LOSS(coarse)
- SSf _ = SODIUM SULFATE LOSS(fine)
- LA _ = LOS ANGELES ABRASION
- DEG _ = DEGRADATION
- LL _ = LIQUID LIMIT (NV = no value)
- PI _ = PLASTIC INDEX (NP = non-plastic)

MISC.

- Tr = TRACE
- sl = SLIGHTLY
- hi = HIGHLY
- w/_ = WITH UNSPECIFIED AMOUNT
- X'tls = CRYSTALS
- TH = TEST HOLE
- TT = TEST TRENCH
- TP = TEST PIT

TYPICAL LOG

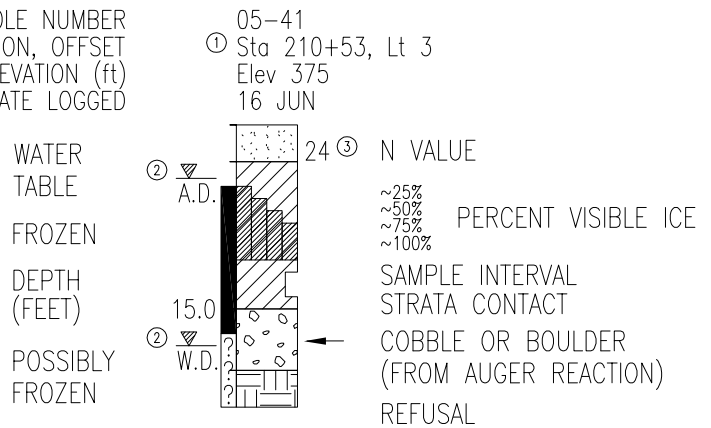

- ① Station value may also be on centerline e.g. Sta 210+53, CL or lat-long format e.g. N64.56789°, W145.67890°
- ② W.D.= WHILE DRILLING, A.D.= AFTER DRILLING
- ③ "N VALUE" INDICATES STANDARD PENETRATION TEST (1.4" I.D., 2.0" O.D. SAMPLER DRIVEN WITH 140 LB. HAMMER, 30" FREE FALL) AND IS SUM OF 2nd AND 3rd 6" OF PENETRATION.

PLAN VIEW SYMBOLS

- POWER AUGER TEST HOLE (TH)
- HAND AUGER TEST HOLE (TH)
- EXPOSED MATERIAL
- PROBE
- HAND DUG TEST PIT (TP)
- DOZER/BACKHOE TEST TRENCH (TT)
- BODY OF WATER
- FLOW DIRECTION
- WASTE BERM
- BANK
- SWAMP
- TREELINE

SOIL DENSITY/CONSISTENCY DESCRIPTORS

NON-COHESIVE		COHESIVE	
RELATIVE DENSITY	BLOWS/FOOT (N) VALUE	CONSISTENCY	BLOWS/FOOT (N) VALUE
VERY LOOSE	< 4	VERY SOFT	< 2
LOOSE	5-10	SOFT	2-4
MEDIUM DENSE	11-30	FIRM	5-8
DENSE	31-50	STIFF	9-15
VERY DENSE	> 50	VERY STIFF	16-30
		HARD	> 30

COLOR

- Bk = BLACK
- Bl = BLUE
- Bn = BROWN
- Gn = GREEN
- Gy = GRAY
- Or = ORANGE
- Rd = RED
- Tn = TAN
- Wh = WHITE
- Yw = YELLOW

MOISTURE

- dry = < OPTIMUM* DUSTY, DRY TO THE TOUCH
- moist ~ OPTIMUM* DAMP, NO VISIBLE WATER
- wet = > OPTIMUM* VISIBLE FREE WATER

* OPTIMUM MOISTURE FOR MAXIMUM DENSITY